

Culver City Police Department

Culver City PD Policy Manual

MISSION, VISION, VALUES

MISSION STATEMENT

"The Culver City Police Department is committed to enhancing our community's quality of life through progressive policing, timely response, and public partnerships."

ORGANIZATIONAL VALUES

Professional

Progressive

Partnerships

Culver City Police Department

Culver City PD Policy Manual

Table of Contents

MISSION, VISION, VALUES.	1
Chapter 1 - Law Enforcement Role and Authority.	7
100 - Law Enforcement Authority.	8
101 - Chief Executive Officer.	11
102 - Oath of Office.	12
103 - Policy Manual.	13
104 - Law Enforcement Code of Ethics.	17
Chapter 2 - Organization and Administration.	18
200 - Organizational Structure and Responsibility.	19
201 - General Order.	22
202 - Emergency Management Plan.	23
203 - Electronic Mail.	24
204 - Administrative Communications.	26
205 - Staffing Levels.	27
206 - License to Carry a Firearm.	28
207 - Retiree Concealed Firearms.	35
208 - Training.	40
Chapter 3 - General Operations.	42
300 - Use of Force.	43
301 - Use of Force Review.	56
302 - Watches, Schedules, & Rotation.	58
303 - Handcuffing and Restraints.	61
304 - Control Devices- Impact Weapons.	66
305 - Conducted Energy Device.	71
306 - Officer-Involved Shootings and Deaths.	77
307 - Firearms.	87
308 - Department Firing Range.	97
309 - Vehicle Pursuits.	99
310 - Officer Response to Calls.	111
311 - Canines.	114
312 - Domestic Violence.	123
313 - Search and Seizure.	131
314 - Temporary Custody of Juveniles.	134
315 - Senior and Disability Victimization.	146
316 - Discriminatory Harassment.	161
317 - Child Abuse.	166
318 - Missing Persons.	174
319 - Public Alerts.	180
320 - Victim and Witness Assistance.	188
321 - Hate Crimes.	191
322 - Standards of Conduct.	202

Culver City Police Department

Culver City PD Policy Manual

323 - Information Technology Use.	209
324 - Report Preparation.	212
325 - Media Relations.	216
326 - Subpoenas and Court Appearances.	220
327 - Reserve Officers.	223
328 - Outside Agency Assistance.	232
329 - Registered Offender Information.	234
330 - Major Incident Notification.	237
331 - Death Investigation.	239
332 - Occupational Injury or Death Response.	243
333 - Identity Theft.	245
334 - Private Persons Arrests.	246
336 - Limited English Proficiency Services.	248
337 - Communications with Persons with Disabilities.	254
338 - Mandatory Employer Notification.	261
339 - Biological Samples.	263
340 - Child and Dependent Adult Safety.	266
341 - Service Animals.	269
342 - Volunteer Program.	272
343 - Flag Flown at Half-Staff.	276
344 - Off-Duty Law Enforcement Actions.	277
345 - Department Use of Social Media.	280
346 - Gun Violence Restraining Orders.	283
347 - Community Relations.	289
348 - Peer Support and Assistance Program.	293
349 - Unmanned Aerial Vehicles (UAV) Operations.	298
350 - Control Devices- Chemical Agents.	309
Chapter 4 - Patrol Operations.	314
400 - Patrol Function.	315
401 - Patrol Equipment.	319
402 - Bias-Based Policing.	321
403 - Briefing Training.	324
404 - Front Desk Officer/Community Service Officer.	325
405 - Crime and Disaster Scene Integrity.	327
406 - Mutual Aid & Tactical Mobilization.	329
407 - Ride-Along Policy.	334
408 - Hazardous Material Response.	337
409 - Hostage and Barricade Incidents.	339
410 - Response to Bomb Calls.	344
411 - Mental Illness Commitments.	349
412 - Cite and Release Policy.	355
413 - Foreign Diplomatic and Consular Representatives.	359
414 - Rapid Response and Deployment.	363
415 - Emergency Utility Service.	366
416 - Rifle.	367
417 - Shotgun.	371

Culver City Police Department

Culver City PD Policy Manual

418 - Field Training Officer Program.	373
419 - Obtaining Air Support.	376
420 - Contacts and Temporary Detentions.	377
421 - Criminal Organizations.	381
422 - Watch Commanders.	386
423 - Mobile Digital Computer Use.	387
424 - Portable Audio/Video Recorders.	390
425 - Medical Marijuana.	392
426 - Bicycle Patrol Unit.	397
427 - Foot Pursuits.	399
428 - Automated License Plate Readers (ALPRs).	404
429 - Homeless Persons.	409
430 - Public Recording of Law Enforcement Activity.	412
431 - Crisis Intervention Incidents.	415
432 - First Amendment Assemblies.	420
433 - Civil Disputes.	428
434 - Suspicious Activity Reporting.	430
435 - Medical Aid and Response.	432
436 - Mobile and Body Audio Video System.	437
437 - Aircraft Accidents.	447
438 - Immigration.	451
439 - Emergency Response Unit.	457
440 - Racial and Identity Profiling Act (RIPA).	467
Chapter 5 - Traffic Operations.	470
500 - Traffic Function and Responsibility.	471
501 - Traffic Collision Reporting.	474
502 - Vehicle Towing and Release.	478
503 - Vehicle Impound Hearings.	482
504 - Impaired Driving.	484
505 - Traffic Citations.	490
506 - 72-Hour Parking Violations.	493
507 - Disabled Vehicles.	495
Chapter 6 - Investigation Operations.	496
600 - Investigation and Prosecution.	497
601 - Senior Lead Detective.	505
602 - Sexual Assault Investigations.	506
603 - Asset Forfeiture.	512
604 - Informants.	519
605 - Terrorist Activity.	525
606 - Eyewitness Identification.	526
607 - Brady Material Disclosure.	530
608 - Warrant Service.	532
609 - Facial Recognition.	535
610 - Forensic Genetic Genealogy.	538

Culver City Police Department

Culver City PD Policy Manual

Chapter 7 - Equipment.	542
700 - Department Owned and Personal Property.	543
701 - Personal Communication Devices.	545
702 - Vehicle Maintenance.	547
703 - Vehicle Use.	549
704 - Military Equipment Funding, Acquisition and Use Policy.	555
705 - NOISE FLASH DIVERSIONARY DEVICE (Flashbangs).	560
706 - Armored Vehicle.	562
Chapter 8 - Support Services.	564
800 - Crime Analysis.	565
801 - Telecommunications Evidence.	566
802 - Property and Evidence Section.	568
803 - Records Section.	578
804 - Records Maintenance and Release.	582
805 - Protected Information.	592
806 - Animal Control.	598
807 - Additional Support Units and Personnel.	602
Chapter 9 - Custody.	603
900 - Jail-Type One Facility.	604
901 - Custodial Searches.	605
902 - Prison Rape Elimination.	611
Chapter 10 - Personnel.	621
1000 - Recruitment and Selection.	622
1001 - Evaluation of Employees.	629
1002 - Grievance Procedure.	633
1003 - Reporting of Arrests, Convictions, and Court Orders.	635
1004 - Drug- and Alcohol-Free Workplace.	637
1005 - Sick Leave.	640
1006 - Communicable Diseases.	642
1007 - Smoking and Tobacco Use.	647
1008 - Personnel Complaints.	648
1009 - Seat Belts.	660
1010 - Body Armor.	662
1011 - Personnel Records.	664
1012 - Request for Change of Assignment.	673
1013 - Commendations and Awards.	674
1014 - Fitness for Duty.	676
1015 - Meal Periods and Breaks.	679
1016 - Lactation Breaks.	680
1017 - Payroll Records.	682
1018 - Overtime Compensation Requests.	683
1019 - Outside Employment.	687
1020 - Occupational Disease and Work-Related Injury Reporting.	692
1021 - Uniform Regulations.	694

Culver City Police Department

Culver City PD Policy Manual

1022 - Nepotism and Conflicting Relationships.	716
1023 - Department Badges.	719
1024 - Seniority.	721
1025 - Temporary Modified-Duty Assignments.	722
1026 - Performance History Audits.	727
1026 - Employee Speech, Expression and Social Networking.	728
1027 - Personal Appearance Standards.	732
1028 - Anti-Retaliation.	736
1029 - Line-of-Duty Deaths.	740
1030 - Wellness Program.	752
1031 - Wellness Dog Program.	757
Attachments.	760
Hate Crime Checklist.pdf.	761
Supplemental Hate Crime Report-Agency.pdf.	762
Supplemental Hate Crime Report.pdf.	763
Military Equipment Attachments.pdf.	764
2021-DOJ_OIS Protocol.pdf.	765
Statutes and Legal Requirements.pdf.	766
Resolution 2017-R025-Declaring-Culver-City-a-sanctuary-city.pdf.	767

Chapter 1 - Law Enforcement Role and Authority

Law Enforcement Authority

100.1 PURPOSE AND SCOPE

The purpose of this policy is to affirm the authority of the members of the Culver City Police Department to perform their functions based on established legal authority.

100.2 PEACE OFFICER POWERS

Sworn members of this department are authorized to exercise peace officer powers pursuant to applicable state law (Penal Code § 830.1 et seq.).

100.2.1 ARREST AUTHORITY OUTSIDE THE JURISDICTION OF THE CULVER CITY POLICE DEPARTMENT

The arrest authority outside the jurisdiction of the Culver City Police Department includes (Penal Code § 830.1; Penal Code § 836):

- (a) When the officer has probable cause to believe the person committed a felony.
- (b) When the officer has probable cause to believe the person has committed a misdemeanor in the presence of the officer and the officer reasonably believes there is immediate danger to person or property or of escape.
- (c) When the officer has probable cause to believe the person has committed a misdemeanor for which an arrest is authorized even if not committed in the presence of the officer such as certain domestic violence offenses and there is immediate danger to person or property or of escape or the arrest is mandated by statute.
- (d) When authorized by a cross jurisdictional agreement with the jurisdiction in which the arrest is made.
- (e) In compliance with an arrest warrant.

On-duty arrests will not generally be made outside the jurisdiction of this department except in cases of hot or fresh pursuit, while following up on crimes committed within the City, or while assisting another agency.

On-duty officers who discover criminal activity outside the jurisdiction of the City should when circumstances permit, consider contacting the agency having primary jurisdiction before attempting an arrest.

100.2.2 ARREST AUTHORITY INSIDE THE JURISDICTION OF THE CULVER CITY POLICE DEPARTMENT

The arrest authority within the jurisdiction of the Culver City Police Department includes (Penal Code § 830.1; Penal Code § 836):

- (a) When the officer has probable cause to believe the person has committed a felony, whether or not committed in the presence of the officer.
- (b) When the officer has probable cause to believe the person has committed a misdemeanor in this jurisdiction and in the presence of the officer.

Culver City Police Department

Culver City PD Policy Manual

Law Enforcement Authority

- (c) When the officer has probable cause to believe the person has committed a public offense outside this jurisdiction, in the presence of the officer and the officer reasonably believes there is an immediate danger to person or property, or of escape.
- (d) When the officer has probable cause to believe the person has committed a misdemeanor for which an arrest is authorized or required by statute even though the offense has not been committed in the presence of the officer such as certain domestic violence offenses.
- (e) In compliance with an arrest warrant.

100.2.3 TIME OF MISDEMEANOR ARRESTS

Officers shall not arrest a person for a misdemeanor between the hours of 10:00 p.m. of any day and 6:00 a.m. of the next day unless (Penal Code § 840):

- (a) The arrest is made without a warrant pursuant to Penal Code § 836 which includes:
 - 1. A misdemeanor committed in the presence of the officer.
 - 2. Misdemeanor domestic violence offenses (See the Domestic Violence Policy).
- (b) The arrest is made in a public place.
- (c) The arrest is made with the person in custody pursuant to another lawful arrest.
- (d) The arrest is made pursuant to a warrant which, for good cause shown, directs that it may be served at any time of the day or night.

100.2.4 OREGON AUTHORITY

Sworn members of this department who enter the state of Oregon in order to provide or attempt to provide law enforcement assistance have Oregon peace officer authority within 50 miles from the California-Oregon border (ORS 133.405). Such authority shall only apply when officers are acting:

- (a) In response to a request for law enforcement assistance initiated by an Oregon sheriff, constable, marshal, municipal police officer or member of the Oregon State Police.
- (b) In response to a reasonable belief that emergency law enforcement assistance is necessary to preserve life, and circumstances make it impractical for Oregon law enforcement officials to formally request assistance.
- (c) For the purpose of assisting Oregon law enforcement officials with emergency assistance in response to criminal activity, traffic accidents, emergency incidents or other similar public safety situations, regardless of whether an Oregon law enforcement official is present at the scene of the incident.

Culver City Police Department officers have no authority to enforce Oregon traffic or motor vehicle laws.

Whenever practicable, officers should seek permission from a department supervisor before entering Oregon to provide law enforcement services. As soon as practicable, officers exercising law enforcement authority in Oregon shall submit any appropriate written reports concerning the incident to the Oregon agency having primary jurisdiction over the area in which the incident occurred.

Culver City Police Department

Culver City PD Policy Manual

Law Enforcement Authority

100.3 POLICY

It is the policy of the Culver City Police Department to limit its members to only exercise the authority granted to them by law.

While this department recognizes the power of peace officers to make arrests and take other enforcement action, officers are encouraged to use sound discretion in the enforcement of the law. This department does not tolerate the abuse of law enforcement authority.

100.4 INTERSTATE PEACE OFFICER POWERS

Peace officer powers may be extended to other states:

- (a) As applicable under interstate compacts, memorandums of understanding or mutual aid agreements in compliance with the laws of each state.
- (b) When an officer enters an adjoining state in close or fresh pursuit of a person believed to have committed a felony (ARS § 13-3832; NRS 171.158; ORS 133.430).

The person arrested out of state must be taken without unnecessary delay before a magistrate of the county in which the arrest was made (ARS § 13-3833; NRS 171.158; ORS 133.440).

100.5 CONSTITUTIONAL REQUIREMENTS

All members shall observe and comply with every person's clearly established rights under the United States and California Constitutions.

Chief Executive Officer

101.1 PURPOSE AND SCOPE

The California Commission on Peace Officer Standards and Training (POST) has mandated that all sworn officers and dispatchers employed within the State of California shall receive certification by POST within prescribed time periods.

101.1.1 CHIEF EXECUTIVE OFFICER REQUIREMENTS

Any chief executive officer of this department appointed after January 1, 1999, shall, as a condition of continued employment, complete the course of training prescribed by POST and obtain the Basic Certificate by POST within two years of appointment (Penal Code § 832.4).

Oath of Office

102.1 PURPOSE AND SCOPE

The purpose of this policy is to ensure that oaths, when appropriate, are administered to department members.

102.2 POLICY

It is the policy of the Culver City Police Department that, when appropriate, department members affirm the oath of their office as an expression of commitment to the constitutional rights of those served by the Department and the dedication of its members to their duties.

102.3 OATH OF OFFICE

All department members, when appropriate, shall take and subscribe to the oaths or affirmations applicable to their positions. All sworn members shall be required to affirm the oath of office expressing commitment and intent to respect constitutional rights in discharging the duties of a law enforcement officer (Cal. Const. Art. 20, § 3; Government Code § 3102). The oath shall be as follows:

“I, (employee name), do solemnly swear (or affirm) that I will support and defend the Constitution of the United States and the Constitution of the State of California against all enemies, foreign and domestic; that I will bear true faith and allegiance to the Constitution of the United States and the Constitution of the State of California; that I take this obligation freely, without any mental reservation or purpose of evasion; and that I will well and faithfully discharge the duties upon which I am about to enter.”

102.4 MAINTENANCE OF RECORDS

The oath of office shall be filed as prescribed by law (Government Code § 3105).

Policy Manual

103.1 PURPOSE AND SCOPE

The manual of the Culver City Police Department is hereby established and shall be referred to as the Policy Manual or the manual. The manual is a statement of the current policies, rules and guidelines of this department. All members are to conform to the provisions of this manual.

All prior and existing manuals, orders and regulations that are in conflict with this manual are rescinded, except to the extent that portions of existing manuals, procedures, orders and other regulations that have not been included herein shall remain in effect, provided that they do not conflict with the provisions of this manual.

103.1.1 DISCLAIMER

The provisions contained in this Policy Manual are not intended to create an employment contract, nor any employment rights or entitlements. The policies contained within this manual are for the internal use of the Culver City Police Department and shall not be construed to create a higher standard or duty of care for civil or criminal liability against the City, its officials or employees. Violations of any provision of any policy contained within this manual shall only form the basis for departmental administrative action, training or discipline. The Culver City Police Department reserves the right to revise any policy content, in whole or in part.

103.2 POLICY

Except where otherwise expressly stated, the provisions of this manual shall be considered as guidelines. It is recognized that the work of law enforcement is not always predictable and circumstances may arise which warrant departure from these guidelines. It is the intent of this manual to be viewed from an objective standard, taking into consideration the sound discretion entrusted to members of this department under the circumstances reasonably available at the time of any incident.

103.2.1 POLICY MANUAL STAFF

The Policy Manual Staff shall consist of the following:

- The Chief of Police
- The Assistant Chief of Police
- The Command Staff
- The Professional Standards Unit (PSU)

The staff shall review all recommendations regarding proposed changes to the manual at staff meetings.

Culver City Police Department

Culver City PD Policy Manual

Policy Manual

103.2.2 OTHER PERSONNEL SUGGESTING CHANGES TO THE POLICY MANUAL

All Department employees suggesting revision of the contents of the Policy Manual shall forward their suggestion, in interoffice memorandum format, to their Bureau Commander via chain of command. The Bureau Commander will consider the recommendation and forward it to staff.

103.3 AUTHORITY

The Chief of Police shall be considered the ultimate authority for the content and adoption of the provisions of this manual and shall ensure compliance with all applicable federal, state and local laws. The Chief of Police or the authorized designee is authorized to issue General Orders, which shall modify those provisions of the manual to which they pertain. General Orders shall remain in effect until such time as they may be permanently incorporated into the manual.

103.3.1 ACCEPTABLE ABBREVIATIONS

The following abbreviations are acceptable substitutions in the manual:

- General Orders may be abbreviated as “GO”
- Policy Manual sections may be abbreviated as “Section 106.X” or “§ 106.X”

103.3.2 DEFINITIONS

The following words and terms shall have these assigned meanings, unless it is apparent from the content that they have a different meaning:

Adult - Any person 18 years of age or older.

CHP - The California Highway Patrol.

CFR - Code of Federal Regulations.

City - The City of Culver City.

Department/CCPD - The Culver City Police Department.

DMV - The Department of Motor Vehicles.

Employee/Personnel - Any person employed by the Department.

Juvenile - Any person under the age of 18 years.

Manual - The Culver City Police Department Policy Manual.

May - Indicates a permissive, discretionary or conditional action.

Member - Any person who is employed or appointed by the Culver City Police Department including sworn officers, reserve officers, professional staff employees and volunteers.

Professional Staff - Employees and volunteers who are not sworn peace officers.

Officer/Sworn - Those employees, regardless of rank, who are sworn employees of the Culver City Police Department.

Culver City Police Department

Culver City PD Policy Manual

Policy Manual

On-Duty - Employee status during the period when he/she is actually engaged in the performance of his/her assigned duties.

Order - A written or verbal instruction issued by a superior.

POST - The California Commission on Peace Officer Standards and Training.

Rank - The job classification title held by an officer.

Shall or will - Indicates a mandatory action.

Should - Indicates a generally required or expected action, absent a rational basis for failing to conform.

USC - United States Code

103.3.3 DISTRIBUTION OF MANUAL

Copies of the Policy Manual should be distributed to the following:

- Chief of Police
- Assistant Chief of Police
- Administrations Bureau Commander
- Operations and Traffic Captain
- Personnel and Training Lieutenant
- Litigations Liaison Lieutenant
- Investigations Bureau
- Watch Commander's Office
- Officer's Report Writing Room

A computerized version of the Policy Manual will be made available on the Department network for access by all employees. The computerized version will be limited to viewing and printing of specific sections. No changes shall be made to the electronic version without authorization from Staff.

This manual contains confidential information and in its entirety is not a public document subject to release under the California Public Records Act. The contents of this manual may not be released to any non-police department employee without the express consent of the Chief of Police or his designee. Any unauthorized release is a violation of department policy.

103.4 ISSUING THE POLICY MANUAL

An electronic version of the Policy Manual will be made available to all members on the department network for viewing and printing. No changes shall be made to the manual without authorization from the Chief of Police or the authorized designee.

Culver City Police Department

Culver City PD Policy Manual

Policy Manual

Each member shall acknowledge that he/she has been provided access to, and has had the opportunity to review the Policy Manual and General Orders. Members shall seek clarification as needed from an appropriate supervisor for any provisions that they do not fully understand.

103.5 PERIODIC REVIEW OF THE POLICY MANUAL

The Chief of Police will ensure that the Policy Manual is periodically reviewed and updated as necessary.

103.6 REVISIONS TO POLICIES

All revisions to the Policy Manual will be provided to each member on or before the date the policy becomes effective. Each member will be required to acknowledge that he/she has reviewed the revisions and shall seek clarification from an appropriate supervisor as needed.

Members are responsible for keeping abreast of all Policy Manual revisions.

Each Bureau Commander will ensure that members under his/her command are aware of any Policy Manual revision.

All department members suggesting revision of the contents of the Policy Manual should forward their written suggestions to their Bureau Commanders, who will consider the recommendations and forward them to the command staff as appropriate.

Law Enforcement Code of Ethics

104.1 PURPOSE AND SCOPE

The purpose of this policy is to ensure that all peace officers are aware of their individual responsibilities to maintain their integrity and that of their department at all times.

104.2 POLICY

The Law Enforcement Code of Ethics shall be administered to all peace officer trainees during the Basic Academy course and to all other persons at the time of appointment (11 CCR 1013).

104.3 LAW ENFORCEMENT CODE OF ETHICS

AS A LAW ENFORCEMENT OFFICER, my fundamental duty is to serve; to safeguard lives and property; to protect the innocent against deception, the weak against oppression or intimidation, and the peaceful against abuse or disorder; and to respect the constitutional rights of all to liberty, equality and justice.

I WILL keep my private life unsullied as an example to all; maintain courageous calm in the face of danger, scorn, or ridicule; develop self-restraint; and be constantly mindful of the welfare of others. Honest in thought and deed in both my personal and official life, I will be exemplary in obeying the laws of the land and the regulations of my department. Whatever I see or hear of a confidential nature or that is confided to me in my official capacity will be kept ever secret unless revelation is necessary in the performance of my duty.

I WILL never act officiously or permit personal feelings, prejudices, animosities or friendships to influence my decisions. With no compromise for crime and with relentless prosecution of criminals, I will enforce the law courteously and appropriately without fear or favor, malice or ill will, never employing unnecessary force or violence and never accepting gratuities.

I RECOGNIZE the badge of my office as a symbol of public faith, and I accept it as a public trust to be held so long as I am true to the ethics of the police service. I will constantly strive to achieve these objectives and ideals, dedicating myself before god to my chosen profession... law enforcement.

104.3.1 OBJECTION TO RELIGIOUS AFFIRMATION

Reference to religious affirmation in the Law Enforcement Code of Ethics may be omitted where objected to by the officer.

Chapter 2 - Organization and Administration

Organizational Structure and Responsibility

200.1 PURPOSE AND SCOPE

The organizational structure of this department is designed to create an efficient means to accomplish our mission and goals and to provide for the best possible service to the public.

200.2 BUREAUS

The Chief of Police is responsible for administering and managing the Culver City Police Department. The Assistant Chief of Police assumes those responsibilities in the absence of the Chief of Police.

There are three bureaus in the Police Department:

- Administration Bureau
- Operations Bureau
- Investigations Bureau

200.2.1 ADMINISTRATION BUREAU

The Administration Bureau is commanded by the Administration Bureau Commander, whose primary responsibility is to provide general management direction and control for the bureau. The Administration Bureau consists of:

- Network Administrator
- Computer Services Unit
- Technical Support Sergeant
- Budget and Grants Section
- Professional Standards Unit (PSU)
- Personnel and Training (Backgrounds, Recruitment, Training, Policy and Procedures)
- Training Coordinator
- Facilities Manager
- Custodians
- Range Master
- Academy Instructor
- Supplies & Services
- Crime Prevention and Media Relations
- Reserve Officer Program
- The Litigation Liaison & Documents Section (Records)
- Evidence/Property Section

Culver City Police Department

Culver City PD Policy Manual

Organizational Structure and Responsibility

200.2.2 OPERATIONS BUREAU

The Operations Bureau is commanded by a Captain whose primary responsibility is to provide general management direction and control for that bureau. The Operations bureau consists of:

- Uniformed Patrol
- Canine officers
- Mental Health Evaluation (MET) Team
- Terrorism Liaison Officer (TLO)
- Jail Operations
- Community Service Officers
- Traffic Section
- Motor Officers
- Commercial Enforcement
- Accident Investigation
- Parking Enforcement
- Automated Enforcement Section
- Animal Services

200.2.3 INVESTIGATIONS BUREAU

The Community Services Bureau is managed by a captain whose primary responsibility is to provide general management direction and control for that bureau. The Community Services Bureau consists of:

- Investigations Division
- Adult Detectives
- SVU/Juvenile
- Crime Impact Team
- Task Force Officers
- Traffic Section
- Motor Officers
- Commercial Enforcement
- Accident Investigation
- Parking Enforcement
- Automated Enforcement Section
- Animal Services

Culver City Police Department

Culver City PD Policy Manual

Organizational Structure and Responsibility

- Crime Management/Analyst
- Community Services Officers
- Forensics

200.3 COMMAND PROTOCOL

200.3.1 SUCCESSION OF COMMAND

The Chief of Police exercises command over all personnel in the Department. During absences, the Assistant Chief will serve as the acting Chief of Police.

Except when designated as above, the order of command authority in the absence or unavailability of the Chief of Police or Assistant Chief of Police is as follows:

- (a) Designated Bureau Commander (Captain)
- (b) The on duty Watch Commander (Lieutenant)
- (c) Lieutenant by seniority in rank

200.3.2 UNITY OF COMMAND

The principles of unity of command ensure efficient supervision and control within the Department. Generally, each employee shall be accountable to one supervisor at any time for a given assignment or responsibility. Except where specifically delegated authority may exist by policy or special assignment (e.g., K-9), any supervisor may temporarily direct any subordinate if an operational necessity exists.

200.3.3 ORDERS

Members shall respond to and make a good faith and reasonable effort to comply with the lawful order of superior officers and other proper authority.

General Order

201.1 PURPOSE AND SCOPE

General Orders establish an interdepartmental communication that may be used by the Chief of Police to make immediate changes to policy and procedure consistent with the current Memorandum(s) of Understanding and as permitted by Government Code § 3500 et seq. General Orders will immediately modify or change and supersede sections of this manual to which they pertain.

201.1.1 GENERAL ORDER PROTOCOL

General Orders will be incorporated into the manual as required upon approval of Staff. General Orders will modify existing policies or create a new policy as appropriate and will be rescinded upon incorporation into the manual.

All existing General Orders have now been incorporated in the updated Policy Manual as of the below revision date.

Any General Orders issued after publication of the manual shall be numbered consecutively starting with the last two digits of the year, followed by the number "01" For example, 11-01 signifies the first General Order for the year 2011.

201.2 RESPONSIBILITIES

201.2.1 STAFF

The Staff shall review and approve revisions of the Policy Manual, which will incorporate changes originally made by a General Order.

201.2.2 CHIEF OF POLICE

The Chief of Police shall issue all General Orders and approve all revisions to the Policy manual.

201.2.3 GENERAL ORDERS, REVISIONS TO THE POLICY MANUAL, AND TRAINING BULLETIN DISTRIBUTION

The Personnel and Training Section will distribute and post revisions to the Policy Manual, General Orders, and Training Bulletins as needed to all departmental personnel. These items will be distributed via electronic mail and may also be posted throughout the station. They will also be available for viewing on Department networks.

Emergency Management Plan

202.1 PURPOSE AND SCOPE

The City has prepared an Emergency Management Plan for use by all employees in the event of a major disaster or other emergency event. The plan provides for a strategic response by all employees and assigns specific responsibilities in the event that the plan is activated (Government Code § 8610).

202.2 ACTIVATING THE EMERGENCY PLAN

The Emergency Management Plan can be activated on the order of the official designated by local ordinance.

202.2.1 RECALL OF PERSONNEL

In the event that the Emergency Management Plan is activated, all employees of the Culver City Police Department are subject to immediate recall. Employees may also be subject to recall during extraordinary circumstances as deemed necessary by the Chief of Police or the authorized designee.

Failure to promptly respond to an order to report for duty may result in discipline.

202.3 LOCATION OF THE PLAN

The manual for the employees is available in the Watch Commander's office. All supervisors should familiarize themselves with the Emergency Management Plan and what roles police personnel will play when the plan is implemented.

202.4 UPDATING OF MANUALS

The Chief of Police or designee shall review the Emergency Management Plan Manual at least once every two years to ensure that the manual conforms to any revisions made by the National Incident Management System (NIMS) and the Standardized Emergency Management System (SEMS) and should appropriately address any needed revisions.

Electronic Mail

203.1 PURPOSE AND SCOPE

The purpose of this policy is to establish guidelines for the proper use and application of the Department's electronic mail (email) system by employees of this department. Email is a communication tool available to employees to enhance efficiency in the performance of job duties and is to be used in accordance with generally accepted business practices and current law (e.g., California Public Records Act). Messages transmitted over the email system must only be those that involve official business activities or contain information essential to employees for the accomplishment of business-related tasks and/or communication directly related to the business, administration, or practices of the Department.

203.2 EMAIL RIGHT OF PRIVACY

All email messages, including any attachments, that are transmitted over department networks are considered department records and therefore are department property. The Department reserves the right to access, audit or disclose, for any lawful reason, any message including any attachment that is transmitted over its email system or that is stored on any department system.

The email system is not a confidential system since all communications transmitted on, to or from the system are the property of the Department. Therefore, the email system is not appropriate for confidential communications. If a communication must be private, an alternative method to communicate the message should be used instead of email. Employees using the Department's email system shall have no expectation of privacy concerning communications utilizing the system.

Employees should not use personal accounts to exchange email or other information that is related to the official business of the Department.

203.3 PROHIBITED USE OF EMAIL

Sending derogatory, defamatory, obscene, disrespectful, sexually suggestive and harassing or any other inappropriate messages on the email system is prohibited and may result in discipline.

Email messages addressed to the entire department are only to be used for official business related items that are of particular interest to all users and must be approved by a supervisor. Personal advertisements are not acceptable.

It is a violation of this policy to transmit a message under another user's name. Users are strongly encouraged to log off the network when their computer is unattended. This added security measure would minimize the misuse of an individual's email, name and/or password by others.

203.4 MANAGEMENT OF E-MAIL

Because the e-mail system is not designed for long-term retention of messages, e-mail that the employee desires to save or that becomes part of an official record should be printed and/or stored in another database. All Department employees are solely responsible for the management of their mailboxes and are required to check their e-mail at least once per work shift. All employees covered by the Fair Labor Standards Act (FLSA) should not access city email while off duty. Such

Culver City Police Department

Culver City PD Policy Manual

Electronic Mail

access is not compensable and is not authorized. Messages should be routinely purged manually by the user. Messages in excess of one month may be automatically purged from the server computer.

Administrative Communications

204.1 PURPOSE AND SCOPE

Administrative communications of this department are governed by the following policies.

204.2 DEPARTMENT E-MAIL

Department E-mail or interdepartmental memorandums may be issued periodically by the Chief of Police or his designee to announce and document all promotions, transfers, hiring of new personnel, separations, personnel and group commendations, or other changes in status.

204.3 CORRESPONDENCE

In order to ensure that the letterhead and name of the Department are not misused, all external correspondence shall be on Department letterhead. All Department letterhead shall bear the signature element of the Chief of Police. Personnel should use Department letterhead only for official business and with approval of their supervisor.

204.4 SURVEYS

All surveys made in the name of the Department shall be authorized by the Chief of Police or a Bureau Commander.

Staffing Levels

205.1 PURPOSE AND SCOPE

The purpose of this policy is to ensure that proper supervision is available for all shifts. The Department intends to balance the employee's needs against the need to have flexibility and discretion in using personnel to meet operational needs. While balance is desirable, the paramount concern is the need to meet operational requirements of the Department.

205.2 MINIMUM STAFFING LEVELS

Minimum staffing levels should result in the scheduling of at least two regular supervisors on duty whenever possible. Watch Commanders should ensure that at least one field supervisor is deployed during each watch, in addition to the Watch Commander.

License to Carry a Firearm

206.1 PURPOSE AND SCOPE

The purpose of this policy is to provide a written process for the application, issuance, denial, appeal, and revocation of a license to carry a firearm (Penal Code § 26150; Penal Code § 26155).

206.1.1 APPLICATION OF POLICY

Nothing in this policy shall preclude the Chief or other head of a municipal police department from entering into an agreement with the Sheriff of the county or preclude the Sheriff of the county from entering into an agreement with the Chief of any municipal police department to process all applications and license renewals for the carrying of concealed weapons (Penal Code § 26150; Penal Code § 26155).

206.2 POLICY

The Culver City Police Department will fairly and impartially consider all applications to carry firearms in accordance with applicable law and this policy.

206.3 QUALIFIED APPLICANTS

In order to qualify for a license to carry a firearm, the applicant must:

- (a) Be deemed not to be a disqualified person as provided in Penal Code § 26202.
- (b) Be deemed not to be prohibited by state or federal law from possessing, receiving, owning, or purchasing a firearm (Penal Code § 26185; Penal Code § 26195).
- (c) Be a resident of the City of Culver City (Penal Code § 26150; Penal Code § 26155).
- (d) Be at least 21 years of age, and present clear evidence of identity and age as defined in Penal Code § 16400 (Penal Code § 26150; Penal Code § 26155).
- (e) Fully complete the California Department of Justice (DOJ) application (Penal Code § 26175).
- (f) Submit fingerprints and a complete criminal background check (Penal Code § 26185).
- (g) Pay all associated application fees (Penal Code § 26190).
- (h) Be the recorded owner of the firearm, with the California DOJ, for which the license will be issued, as determined by the Culver City Police Department (Penal Code § 26162).
- (i) Be free from any psychological conditions that might make the applicant unsuitable for carrying a firearm (Penal Code § 26190).
- (j) Complete required training described in Penal Code § 26165.

206.4 APPLICATION PROCESS

The application process for a license to carry a firearm shall consist of two phases. Upon the successful completion of each phase, the applicant will advance to the next phase until the process is completed and the license is either issued or denied.

Culver City Police Department

Culver City PD Policy Manual

License to Carry a Firearm

206.4.1 PHASE ONE (TO BE COMPLETED BY ALL APPLICANTS)

- (a) Any individual applying for a license to carry a firearm shall first fully complete a California DOJ application to be signed under penalty of perjury. Any applicant who provides false information or statements on the application will be removed from further consideration and may be prosecuted for a criminal offense (Penal Code § 26180).
 - 1. If an incomplete application package is received, the Chief of Police or the authorized designee may do any of the following:
 - (a) Require the applicant to complete the package before any further processing.
 - (b) Advance the incomplete package to phase two for conditional processing pending completion of all mandatory conditions.
 - (c) Issue a denial if the materials submitted at the time demonstrate that the applicant would not qualify for a license to carry a firearm even if the package was completed (e.g., not a resident, disqualifying criminal conviction).
- (b) Applicant fees shall be submitted and processed according to department-established procedures and Penal Code § 26190.
 - 1. Additional fees may be required for fingerprinting, training, or psychological testing, in addition to the application fee.
 - 2. Full payment of the remainder of the application fee will be required upon issuance of a license.
 - 3. Payment of related fees may be waived if the applicant is a duly appointed reserve peace officer as defined in Penal Code § 830.6 (a) or (b) (Penal Code § 26170).
- (c) Additional documents may be requested of the applicant as required to complete the application process (e.g., photograph, proof of residency).
- (d) The applicant shall submit proof of ownership or registration of each firearm to be licensed.

Within 90 days of receiving the completed application for a new license, the Department shall give written notice to the applicant of the Department's initial determination, based on its preliminary investigation, whether or not the applicant is a disqualified person (Penal Code § 26202).

If the determination is that the applicant is not a disqualified person, the notice shall inform the applicant to proceed with the training requirements as specified in Penal Code § 26165.

206.4.2 PHASE TWO

This phase is to be completed only by those applicants successfully completing phase one.

- (a) Fingerprints and related information required by the California DOJ shall be submitted to the California DOJ as provided in Penal Code § 26185.

Culver City Police Department

Culver City PD Policy Manual

License to Carry a Firearm

- (b) The Chief of Police may, based upon criteria established by the Chief of Police, require that the applicant be referred to an authorized psychologist used by the Department for psychological testing. The cost of such psychological testing shall be paid by the applicant but shall not exceed the reasonable costs to the Department (Penal Code § 26190).
- (c) The applicant shall complete a course of training approved by the Department, which complies with Penal Code § 26165.
- (d) The applicant shall submit any firearm to be considered for a license to the Rangemaster or other department authorized gunsmith, at no cost to the applicant, for a full safety inspection. The Chief of Police reserves the right to deny a license for any firearm that has been altered from the manufacturer's specifications or that is unsafe (Penal Code § 31910).
- (e) The applicant shall successfully complete a firearms safety and proficiency examination with the firearm to be licensed, to be administered by the department Rangemaster, or provide proof of successful completion of another department-approved firearms safety and proficiency examination, including completion of all releases and other forms. The cost of any outside inspection/examination shall be the responsibility of the applicant.

Once the Chief of Police or authorized designee has verified the successful completion of phase two, the license to carry a firearm will either be granted or denied (Penal Code § 26170).

206.5 ISSUED FIREARMS PERMITS

In the event a license to carry a firearm is issued by the Chief of Police, the following shall apply:

- (a) The license will be subject to any and all reasonable restrictions or conditions the Chief of Police has deemed warranted, including restrictions as to the time, place, manner, and circumstances under which a person may carry the firearm (Penal Code § 26200(b)).
 - 1. All such restrictions or conditions shall be conspicuously noted on any license issued (Penal Code § 26200(c)).
 - 2. The licensee will be required to sign a Restrictions and Conditions Agreement. Any violation of any of the restrictions and conditions may result in the immediate revocation of the license.
- (b) The license shall clearly identify the licensee, bear a photograph and fingerprints of the licensee with the expiration date, type of firearm, restrictions, and other pertinent information as described by Penal Code § 26175. The license may be laminated (Penal Code § 26175).
- (c) The license will be valid for a period not to exceed two years from the date of issuance (Penal Code § 26220).
 - 1. A license issued to a state or federal magistrate, commissioner, or judge will be valid for a period not to exceed three years.
 - 2. A license issued to any reserve peace officer as defined in Penal Code § 830.6(a) or (b), or a custodial officer employed by the Sheriff as provided in

Culver City Police Department

Culver City PD Policy Manual

License to Carry a Firearm

Penal Code § 831.5 will be valid for a period not to exceed four years, except that such license shall be invalid upon the individual's conclusion of service as a reserve officer.

- (d) If the licensee's place of residence was the basis for issuance of a license and the licensee moves out of the county of issuance, the license shall expire 90 days after the licensee has moved (Penal Code § 26210).
- (e) The licensee shall notify this department in writing within 10 days of any change of place of residency. Within 10 days of receiving such notice, the Department shall notify the California DOJ (Penal Code § 26210).

206.5.1 LICENSE RESTRICTIONS

- (a) The Chief of Police may place special restrictions limiting time, place, manner and circumstances under which any license shall be valid. In general, these restrictions will prohibit the licensee from:
 - 1. Consuming any alcoholic beverage while armed.
 - 2. Falsely representing him/herself as a peace officer.
 - 3. Unjustified or unreasonable displaying of a firearm.
 - 4. Committing any crime.
 - 5. Being under the influence of any medication or drug while armed.
 - 6. Interfering with any law enforcement officer's duties.
 - 7. Refusing to display his/her license or firearm for inspection upon demand of any peace officer.
 - 8. Loading the permitted firearm with illegal ammunition.
 - 9. Entering a location, both public and private, where it is expressly prohibited to carry a firearm, i.e., stadiums, arenas, amusement parks.
- (b) The Chief of Police reserves the right to inspect any license or licensed firearm at any time.
- (c) The alteration of any previously approved firearm including, but not limited to adjusting the trigger pull, adding laser sights or modifications shall void any license and serve as grounds for revocation.

206.5.2 AMENDMENTS TO LICENSES

Any licensee may apply to amend a license at any time during the period of validity by completing and submitting a written Application for License Amendment along with the current processing fee to the Department in order to (Penal Code § 26215):

- (a) Add or delete authority to carry a firearm listed on the license.
- (b) Change restrictions or conditions previously placed on the license.
- (c) Change the address or other personal information of the licensee (Penal Code § 26210).

Culver City Police Department

Culver City PD Policy Manual

License to Carry a Firearm

In the event that any amendment to a valid license is approved by the Chief of Police, a new license will be issued reflecting the amendment. An amendment to any license will not serve to extend the original expiration date and an application for an amendment will not constitute an application for renewal of the license.

206.5.3 REVOCATION OF LICENSES

Any license issued pursuant to this policy shall be revoked by the Chief of Police for any of the following reasons (Penal Code § 26195):

- (a) The licensee is prohibited by state or federal law from owning or purchasing a firearm.
- (b) The licensee has become a disqualified person and cannot receive such a license in accordance with the standards set forth in Penal Code § 26202.
- (c) The licensee has breached any of the conditions or restrictions described in Penal Code § 26200.
- (d) Any information provided by a licensee in connection with an application for a new license or a license renewal is inaccurate or incomplete.
- (e) If the license is one to carry "loaded and exposed," the license shall be revoked immediately upon a change of the licensee's place of residence to another county (Penal Code § 26210).

The issuance of a license by the Chief of Police shall not entitle the holder to either a property or liberty interest as the issuance, amendment, or revocation of such license remains exclusively within the discretion of the Chief of Police as set forth herein.

If any license is revoked, the Department will immediately notify the licensee in writing and the California DOJ (Penal Code § 26225).

206.5.4 LICENSE RENEWAL

No later than 90 days prior to the expiration of any valid license to carry a firearm, the licensee may apply to the Chief of Police for a renewal by:

- (a) Verifying all information submitted in the original application under penalty of perjury.
- (b) Completing a training course pursuant to Penal Code § 26165.
- (c) Submitting any firearm to be considered for a license renewal to the Rangemaster for a full safety inspection. The Chief of Police reserves the right to deny a license for any firearm that has been altered from the manufacturer's specifications or that is unsafe (Penal Code § 31910).
- (d) Paying the applicable renewal application fee.

Within 90 days of receiving the completed application for a renewal license, the Department shall give written notice to the applicant of the department's initial determination whether or not the applicant is a disqualified person (Penal Code § 26202).

If the determination is that the applicant is not a disqualified person, the notice shall inform the applicant to proceed with the training requirements as specified in Penal Code § 26165. The

Culver City Police Department

Culver City PD Policy Manual

License to Carry a Firearm

Department shall then submit the renewal notification to the California DOJ as provided in Penal Code § 26185.

Once the Chief of Police or the authorized designee has verified the successful completion of the renewal process, the renewal of the license to carry a firearm will either be granted or denied.

206.6 DEPARTMENT REPORTING AND RECORDS

The Department shall maintain a record of the following and immediately provide copies of each to the California DOJ (Penal Code § 26225):

- (a) The denial of a license
- (b) The denial of an amendment to a license
- (c) The issuance of a license
- (d) The amendment of a license
- (e) The revocation of a license

The Chief of Police shall annually submit to the State Attorney General the total number of licenses to carry firearms issued to reserve peace officers and judges.

206.7 CONFIDENTIAL RECORDS

The home address and telephone numbers of any peace officer, public defender, prosecutor, magistrate, court commissioner, or judge contained in an application shall not be considered a public record (Government Code § 7923.805).

206.8 LIMITED BUSINESS LICENSE TO CARRY A CONCEALED FIREARM

The authority to issue a limited business license to carry a concealed firearm to a non-resident applicant is granted only to the Sheriff of the county in which the applicant works. A chief of a municipal police department may not issue limited licenses and these applicants should be referred to the Sheriff's Office (Penal Code § 26150).

An individual who is not a resident of the county but who otherwise successfully completes all portions of phases one and two above, may apply for and be issued a limited license subject to approval by the Sheriff and subject to the following:

- (a) The applicant physically spends a substantial period of working hours in the applicant's principal place of employment or business within the City of Culver City (Penal Code § 26150).
- (b) Such a license will be valid for a period not to exceed 90 days from the date of issuance (Penal Code § 26220).
- (c) The applicant shall provide a copy of the license to the licensing authority of the city or county in which the applicant resides (Penal Code § 26220).
- (d) Any application for renewal or reissuance of such a license may be granted only upon concurrence of the original issuing authority and the licensing authority of the city or county in which the applicant resides (Penal Code § 26220).

Culver City Police Department

Culver City PD Policy Manual

License to Carry a Firearm

206.9 WRITTEN NOTICE FOR DENIAL OF LICENSE

The Chief of Police or the authorized designee shall give written notice to the applicant for a new license that the license is approved or denied within 120 days of the initial application or within 30 days after receipt of the applicant's criminal background check from the California DOJ, whichever is later (Penal Code § 26205).

Written notice to an applicant for a renewal license that is approved or denied shall be given within 120 days of receiving the completed application (Penal Code § 26205).

Additionally, regardless of the type of license, if the license is denied, the notice shall state which requirement was not satisfied (Penal Code § 26205).

206.9.1 ADDITIONAL REQUIREMENTS

If an application for a new license, renewal of a license, or revocation is denied based on a determination that the person is a disqualified person as provided by Penal Code § 26202, the Chief of Police or the authorized designee shall provide the person with the notice of determination as provided by Penal Code § 26202(d), Penal Code § 26205, or Penal Code § 26195(b)(3). The notice shall state the reason why the determination was made and inform the applicant that they may request a hearing from a court. The Department shall also provide the most recent California DOJ hearing request form to the applicant (Penal Code § 26206).

If an application for a new license, renewal of a license, or revocation is denied for any other reason as described in Penal Code § 26206(i), the Chief of Police or the authorized designee shall provide the person with the notice required under Penal Code § 26205 or Penal Code § 26195(b)(3), as applicable, and inform the applicant they may apply to the county Superior Court for a writ of mandate pursuant to Code of Civil Procedure § 1085 (Penal Code § 26206).

206.10 POLICY AVAILABILITY

This policy shall be made accessible to the public as provided by Penal Code § 26160.

Retiree Concealed Firearms

207.1 PURPOSE AND SCOPE

The purpose of this policy is to provide guidelines for the issuance, denial, suspension or revocation of Culver City Police Department identification cards under the Law Enforcement Officers' Safety Act (LEOSA) and California law (18 USC § 926C; Penal Code § 25455).

207.2 POLICY

It is the policy of the Culver City Police Department to provide identification cards to qualified former or retired officers as provided in this policy.

207.3 LEOSA

The Chief of Police may issue an identification card for LEOSA purposes to any qualified former officer of this department who (18 USC § 926C(c)):

- (a) Separated from service in good standing from this department as an officer.
- (b) Before such separation, had regular employment as a law enforcement officer for an aggregate of 10 years or more or, if employed as a law enforcement officer for less than 10 years, separated from service after completing any applicable probationary period due to a service-connected disability as determined by this department.
- (c) Has not been disqualified for reasons related to mental health.
- (d) Has not entered into an agreement with this department where the officer acknowledges that he/she is not qualified to receive a firearm qualification certificate for reasons related to mental health.
- (e) Is not prohibited by federal law from receiving or possessing a firearm.

207.3.1 LEOSA IDENTIFICATION CARD FORMAT

The LEOSA identification card should contain a photograph of the former officer and identify him/her as having been employed as an officer.

If the Culver City Police Department qualifies the former officer, the LEOSA identification card or separate certification should indicate the date the former officer was tested or otherwise found by the Department to meet the active duty standards for qualification to carry a firearm.

207.3.2 AUTHORIZATION

Any qualified former law enforcement officer, including a former officer of this department, may carry a concealed firearm under 18 USC § 926C when he/she is:

- (a) In possession of photographic identification that identifies him/her as having been employed as a law enforcement officer, and one of the following:
 - 1. An indication from the person's former law enforcement agency that he/she has, within the past year, been tested or otherwise found by the law enforcement agency to meet agency-established active duty standards for qualification in firearms training to carry a firearm of the same type as the concealed firearm.

Culver City Police Department

Culver City PD Policy Manual

Retiree Concealed Firearms

2. A certification, issued by either the state in which the person resides or by a certified firearms instructor who is qualified to conduct a firearms qualification test for active duty law enforcement officers within that state, indicating that the person has, within the past year, been tested or otherwise found to meet the standards established by the state or, if not applicable, the standards of any agency in that state.
 - (b) Not under the influence of alcohol or another intoxicating or hallucinatory drug or substance.
 - (c) Not prohibited by federal law from receiving a firearm.
 - (d) Not in a location prohibited by California law or by a private person or entity on his/her property if such prohibition is permitted by California law.

207.4 CALIFORNIA IDENTIFICATION CARD ISSUANCE

Any full-time sworn officer of this department who was authorized to, and did, carry a concealed firearm during the course and scope of his/her employment shall be issued an identification card with a Carrying Concealed Weapon endorsement, "CCW Approved," upon honorable retirement (Penal Code § 25455).

- (a) For the purpose of this policy, honorably retired includes all peace officers who have qualified for, and accepted, a service or disability retirement. It shall not include any officer who retires in lieu of termination.
- (b) No CCW Approved endorsement shall be issued to any officer retiring because of a psychological disability (Penal Code § 26305).

207.4.1 CALIFORNIA IDENTIFICATION CARD FORMAT

The identification card issued to any qualified and honorably retired officer shall be 2 inches by 3 inches, and minimally contain (Penal Code § 25460):

- (a) A photograph of the retiree.
- (b) The retiree's name and date of birth.
- (c) The date of retirement.
- (d) The name and address of this department.
- (e) A stamped CCW Approved endorsement along with the date by which the endorsement must be renewed (not more than one year). If a CCW endorsement has been denied or revoked, the identification card shall be stamped "No CCW Privilege."

207.4.2 QUALIFIED RETIREES FROM INCORPORATED JURISDICTION

The Culver City Police Department shall provide an identification card with a CCW Approved endorsement to honorably retired peace officers from any jurisdiction that this department now serves under the following conditions (Penal Code § 25905):

- (a) The retiree's previous agency is no longer providing law enforcement services or the relevant government body is dissolved.

Culver City Police Department

Culver City PD Policy Manual

Retiree Concealed Firearms

- (b) This department is in possession of the retiree's complete personnel record or can verify the retiree's honorably retired status.
- (c) The retiree is in compliance with all of the requirements of this department for the issuance of a CCW Approved endorsement.

207.4.3 QUALIFIED RETIRED RESERVES

Qualified retired reserve officers who meet the department requirements shall be provided an identification card with a CCW Approved endorsement (Penal Code § 26300).

207.5 FORMER OFFICER RESPONSIBILITIES

A former officer with a card issued under this policy shall immediately notify the Watch Commander of his/her arrest or conviction in any jurisdiction, or that he/she is the subject of a court order, in accordance with the Reporting of Employee Convictions policy.

207.5.1 RESPONSIBILITIES UNDER LEOSA

In order to obtain or retain a LEOSA identification card, the former officer shall:

- (a) Sign a waiver of liability of the Department for all acts taken related to carrying a concealed firearm, acknowledging both his/her personal responsibility as a private person for all acts taken when carrying a concealed firearm as permitted by LEOSA and also that these acts were not taken as an employee or former employee of the Department.
- (b) Remain subject to all applicable department policies and federal, state and local laws.
- (c) Demonstrate good judgment and character commensurate with carrying a loaded and concealed firearm.
- (d) Successfully pass an annual criminal history background check indicating that he/she is not prohibited by law from receiving or possessing a firearm.

207.5.2 MAINTAINING A CALIFORNIA IDENTIFICATION CARD CCW ENDORSEMENT

In order to maintain a CCW Approved endorsement on an identification card issued under California law, the retired officer shall (Penal Code § 26305):

- (a) Qualify annually with the authorized firearm at a course approved by this department at the retired officer's expense.
- (b) Remain subject to all applicable department policies and federal, state and local laws.
- (c) Not engage in conduct that compromises public safety.
- (d) Only be authorized to carry a concealed firearm inspected and approved by the Department.

207.6 DENIAL, SUSPENSION, OR REVOCATION OF A LEOSA IDENTIFICATION CARD

A LEOSA identification card may be denied or revoked upon a showing of good cause as determined by the Department. In the event that an identification card is denied, suspended, or revoked, the former officer may request a review by the Chief of Police. The decision of the Chief of Police is final.

Culver City Police Department

Culver City PD Policy Manual

Retiree Concealed Firearms

207.7 FIREARM QUALIFICATIONS

The Rangemaster may provide former officers from this department an opportunity to qualify. Written evidence of the qualification and the weapons used will be provided and will contain the date of the qualification. The Rangemaster will maintain a record of the qualifications and weapons used.

207.8 DENIAL, SUSPENSION, OR REVOCATION OF A CALIFORNIA CCW ENDORSEMENT CARD

A CCW endorsement for any officer retired from this department may be denied or revoked only upon a showing of good cause. The CCW endorsement may be immediately and temporarily revoked by the Watch Commander when the conduct of a retired peace officer compromises public safety (Penal Code § 25470).

- (a) In the event that a CCW endorsement is initially denied, the retired officer shall have 15 days from the date of denial to request a formal hearing. The failure to submit a timely written request for a hearing shall be deemed a waiver of such right. The hearing, absent written agreement between the parties, shall be held no later than 120 days after the request is received.
- (b) Prior to revocation of any CCW endorsement, the Department shall provide the affected retiree with written notice of a hearing by either personal service or first class mail, postage prepaid, return receipt requested to the retiree's last known address (Penal Code § 26315).
 1. The retiree shall have 15 days from the date of service to file a written request for a hearing.
 2. The hearing, absent written agreement between the parties, shall be held no later than 120 days after the request is received (Penal Code § 26315).
 3. The failure to submit a timely written request for a hearing shall be deemed a waiver of such right.
- (c) A hearing for the denial or revocation of any CCW endorsement shall be conducted before a hearing board composed of three members, one selected by the Department, one selected by the retiree or his/her employee organization, and one selected jointly (Penal Code § 26320).
 1. The decision of such hearing board shall be binding on the Department and the retiree.
 2. Any retiree who waives the right to a hearing or whose CCW endorsement has been revoked at a hearing shall immediately surrender his/her identification card. The Department will then reissue a new identification card which shall be stamped "No CCW Privilege."
- (d) Members who have reason to suspect the conduct of a retiree has compromised public safety shall notify the Watch Commander as soon as practicable. The Watch Commander should promptly take appropriate steps to look into the matter and, if warranted, contact the retiree in person and advise him/her of the temporary suspension and hearing information listed below.

Culver City Police Department

Culver City PD Policy Manual

Retiree Concealed Firearms

1. Notification of the temporary suspension should also be promptly mailed to the retiree via first class mail, postage prepaid, return receipt requested (Penal Code § 26312).
2. The Watch Commander should document the investigation, the actions taken and, if applicable, any notification made to the retiree. The memo should be forwarded to the Chief of Police.
3. The personal and written notification should be as follows:
 - (a) The retiree's CCW endorsement is immediately and temporarily suspended.
 - (b) The retiree has 15 days to request a hearing to determine whether the temporary suspension should become permanent revocation.
 - (c) The retiree will forfeit his/her right to a hearing and the CCW endorsement will be permanently revoked if the retiree fails to respond to the notice of hearing within the 15-day period.
4. In the event that personal contact with the retiree cannot be reasonably achieved in a timely manner, the Watch Commander should attempt to make the above notice of temporary suspension through another law enforcement officer. For example, if a retiree was arrested or detained by a distant agency, the Watch Commander may request that a law enforcement officer from that agency act as the agent of the Department to deliver the written notification.

Training

208.1 PURPOSE AND SCOPE

It is the policy of this department to administer a training program that will provide for the professional growth and continued development of its personnel. By doing so, the Department will ensure its personnel possess the knowledge and skills necessary to provide a professional level of service that meets the needs of the community.

208.2 PHILOSOPHY

The Department seeks to provide ongoing training and encourages all personnel to participate in advanced training and formal education on a continual basis. Training is provided within the confines of funding, requirements of a given assignment, staffing levels, and legal mandates. Whenever possible, the Department will use courses certified by the California Commission on Peace Officer Standards and Training (POST).

208.3 OBJECTIVES

The objectives of the Training Program are to:

- (a) Enhance the level of law enforcement service to the public.
- (b) Increase the technical expertise and overall effectiveness of our personnel.
- (c) Provide for continued professional development of department personnel.
- (d) Ensure compliance with POST rules and regulations concerning law enforcement training.

208.4 TRAINING PLAN

A training plan will be developed and maintained by the Personnel and Training Lieutenant. It is the responsibility of the Personnel and Training Lieutenant to maintain, review, and update the training plan on an annual basis.

208.5 TRAINING NEEDS ASSESSMENT

The Personnel and Training will conduct an annual training-needs assessment of the Department. The needs assessment will be reviewed by staff. Upon approval by the staff, the needs assessment will form the basis for the training plan for the fiscal year.

208.6 TRAINING PROCEDURES

- (a) All employees assigned to attend training shall attend as scheduled unless previously excused by their immediate supervisor. Excused absences from mandatory training should be limited to the following:
 - 1. Court appearances
 - 2. First choice vacation
 - 3. Sick leave

Culver City Police Department

Culver City PD Policy Manual

Training

4. Physical limitations preventing the employee's participation.
 5. Emergency situations
- (b) When an employee is unable to attend mandatory training, that employee shall:
1. Notify his/her supervisor as soon as possible but no later than one hour prior to the start of training.
 2. Make arrangements through his/her supervisor and the Personnel and Training Lieutenant to attend the required training on an alternate date.

208.7 POLICY

The Department shall administer a training program that will meet the standards of federal, state, local, and POST training requirements. It is a priority of this department to provide continuing education and training for the professional growth and development of its members.

208.8 PERSONNEL AND TRAINING LIEUTENANT

The Chief of Police shall designate a Personnel and Training Lieutenant who is responsible for developing, reviewing, updating, and maintaining the department training plan so that required training is completed. The Personnel and Training Lieutenant should review the training plan annually.

208.8.1 TRAINING RESTRICTION

The Personnel and Training Lieutenant is responsible for establishing a process to identify officers who are restricted from training other officers for the time period specified by law because of a sustained use of force complaint (Government Code § 7286(b)).

Chapter 3 - General Operations

Use of Force

300.1 PURPOSE AND SCOPE

This policy provides guidelines on the reasonable use of force. While there is no way to specify the exact amount or type of reasonable force to be applied in any situation, every member of this department is expected to use these guidelines to make such decisions in a professional, impartial, and reasonable manner (Government Code § 7286).

In addition to those methods, techniques, and tools set forth below, the guidelines for the reasonable application of force contained in this policy shall apply to all policies addressing the potential use of force, including but not limited to the Control Devices and Techniques and Conducted Energy Device policies.

Retaliation prohibitions for reporting suspected violations are addressed in the Anti-Retaliation Policy.

300.2 POLICY

The use of force by law enforcement personnel is a matter of critical concern, both to the public and to the law enforcement community. Officers are involved on a daily basis in numerous and varied interactions and, when warranted, may use reasonable force in carrying out their duties.

Officers must have an understanding of, and true appreciation for, their authority and limitations. This is especially true with respect to overcoming resistance while engaged in the performance of law enforcement duties.

The Department recognizes and respects the value of all human life and dignity without prejudice to anyone. The Department affirms its commitment to unbiased policing and equitably applying this use of force policy in all its encounters between officers and members of the public. Vesting officers with the authority to use reasonable force and to protect the public welfare requires monitoring, evaluation and a careful balancing of all interests.

300.2.1 DUTY TO INTERCEDE

Any officer present and observing another law enforcement officer or an employee using force that is clearly beyond that which is necessary, as determined by an objectively reasonable officer under the circumstances, shall, when in a position to do so, intercede (as defined by Government Code § 7286) to prevent the use of unreasonable force.

When observing force used by a law enforcement officer, each officer should take into account the totality of the circumstances and the possibility that other law enforcement officers may have additional information regarding the threat posed by the subject (Government Code § 7286(b)).

300.2.2 FAIR AND UNBIASED USE OF FORCE

Officers are expected to carry out their duties, including the use of force, in a manner that is fair and unbiased (Government Code § 7286(b)). See the Bias-Based Policing Policy for additional guidance.

Culver City Police Department

Culver City PD Policy Manual

Use of Force

300.2.3 DUTY TO REPORT EXCESSIVE FORCE

Any officer who observes a law enforcement officer or an employee use force that potentially exceeds what the officer reasonably believes to be necessary shall immediately report these observations to a supervisor (Government Code § 7286(b)).

As used in this subsection, "immediately" means as soon as it is safe and feasible to do so.

300.2.4 FAILURE TO INTERCEDE

An officer who has received the required training on the duty to intercede and then fails to act to intercede when required by law, may be disciplined in the same manner as the officer who used force beyond that which is necessary (Government Code § 7286(b)).

300.3 USE OF FORCE

Officers shall use only that amount of force that reasonably appears necessary given the facts and totality of the circumstances known to or perceived by the officer at the time of the event to accomplish a legitimate law enforcement purpose (Penal Code § 835a).

The reasonableness of force will be judged from the perspective of a reasonable officer on the scene at the time of the incident. Any evaluation of reasonableness must allow for the fact that officers are often forced to make split-second decisions about the amount of force that reasonably appears necessary in a particular situation, with limited information and in circumstances that are tense, uncertain, and rapidly evolving.

Given that no policy can realistically predict every possible situation an officer might encounter, officers are entrusted to use well-reasoned discretion in determining the appropriate use of force in each incident. Officers may only use a level of force that they reasonably believe is proportional to the seriousness of the suspected offense or the reasonably perceived level of actual or threatened resistance (Government Code § 7286(b)).

It is also recognized that circumstances may arise in which officers reasonably believe that it would be impractical or ineffective to use any of the approved or authorized tools, weapons, or methods provided by the Department. Officers may find it more effective or reasonable to improvise their response to rapidly unfolding conditions that they are confronting. In such circumstances, the use of any improvised device or method must nonetheless be objectively reasonable and utilized only to the degree that reasonably appears necessary to accomplish a legitimate law enforcement purpose.

While the ultimate objective of every law enforcement encounter is to avoid or minimize injury, nothing in this policy requires an officer to retreat or be exposed to possible physical injury before applying reasonable force.

300.3.1 USE OF FORCE TO EFFECT AN ARREST

Any peace officer who has reasonable cause to believe that the person to be arrested has committed a public offense may use objectively reasonable force to effect an arrest, to prevent escape, or to overcome resistance. A peace officer who makes or attempts to make an arrest need not retreat or desist from their efforts by reason of the resistance or threatened resistance

Culver City Police Department

Culver City PD Policy Manual

Use of Force

on the part of the person being arrested; nor shall an officer be deemed the aggressor or lose their right to self-defense by the use of objectively reasonable force to effect the arrest, prevent escape, or to overcome resistance. Retreat does not mean tactical repositioning or other de-escalation techniques (Penal Code § 835a).

300.3.2 FACTORS USED TO DETERMINE THE REASONABLENESS OF FORCE

When determining whether to apply force and evaluating whether an officer has used reasonable force, a number of factors should be taken into consideration, as time and circumstances permit (Government Code § 7286(b)). These factors include but are not limited to:

- (a) The apparent immediacy and severity of the threat to officers or others (Penal Code § 835a).
- (b) The conduct of the individual being confronted, as reasonably perceived by the officer at the time (Penal Code § 835a).
- (c) Officer/individual factors (age, size, relative strength, skill level, injuries sustained, level of exhaustion or fatigue, the number of officers available vs. individuals).
- (d) The conduct of the involved officer leading up to the use of force (Penal Code § 835a).
- (e) The effects of suspected drugs or alcohol.
- (f) The individual's apparent mental state or capacity (Penal Code § 835a).
- (g) The individual's apparent ability to understand and comply with officer commands (Penal Code § 835a).
- (h) Proximity of weapons or dangerous improvised devices.
- (i) The degree to which the individual has been effectively restrained and his/her ability to resist despite being restrained.
- (j) The availability of other reasonable and feasible options and their possible effectiveness (Penal Code § 835a).
- (k) Seriousness of the suspected offense or reason for contact with the individual prior to and at the time force is used.
- (l) Training and experience of the officer.
- (m) Potential for injury to officers, suspected persons, bystanders, and others.
- (n) Whether the person appears to be resisting, attempting to evade arrest by flight, or is attacking the officer.
- (o) The risk and reasonably foreseeable consequences of escape.
- (p) The apparent need for immediate control of the individual or a prompt resolution of the situation.
- (q) Whether the conduct of the individual being confronted no longer reasonably appears to pose an imminent threat to the officer or others.
- (r) Prior contacts with the individual or awareness of any propensity for violence.
- (s) Any other exigent circumstances.

Culver City Police Department

Culver City PD Policy Manual

Use of Force

300.3.3 PAIN COMPLIANCE TECHNIQUES

Pain compliance techniques may be effective in controlling a physically or actively resisting individual. Officers may only apply those pain compliance techniques for which they have successfully completed department-approved training. Officers utilizing any pain compliance technique should consider:

- (a) The degree to which the application of the technique may be controlled given the level of resistance.
- (b) Whether the person can comply with the direction or orders of the officer.
- (c) Whether the person has been given sufficient opportunity to comply.

The application of any pain compliance technique shall be discontinued once the officer determines that compliance has been achieved.

300.3.4 USE OF FORCE TO SEIZE EVIDENCE

In general, officers may use reasonable force to lawfully seize evidence and to prevent the destruction of evidence. However, officers are discouraged from using force solely to prevent a person from swallowing evidence or contraband. In the event that evidence or contraband is swallowed by an individual, emergency medical treatment shall be promptly summoned to the scene.

300.3.5 RESTRICTIONS ON THE USE OF CAROTID CONTROL HOLD

Officers of this department are not authorized to use a carotid restraint hold. A carotid restraint means a vascular neck restraint or any similar restraint, hold, or other defensive tactic in which pressure is applied to the sides of a person's neck that involves a substantial risk of restricting blood flow and may render the person unconscious in order to subdue or control the person (Government Code § 7286.5).

300.3.6 RESTRICTIONS ON THE USE OF A CHOKE HOLD

Officers of this department are not authorized to use a choke hold. A choke hold means any defensive tactic or force option in which direct pressure is applied to a person's trachea or windpipe (Government Code § 7286.5).

300.3.7 ALTERNATIVE TACTICS - DE-ESCALATION

As time and circumstances reasonably permit, and when community and officer safety would not be compromised, officers should consider actions that may increase officer safety and may decrease the need for using force:

- (a) Summoning additional resources that are able to respond in a reasonably timely manner.
- (b) Formulating a plan with responding officers before entering an unstable situation that does not reasonably appear to require immediate intervention.
- (c) Employing other tactics that do not unreasonably increase officer jeopardy.

Culver City Police Department

Culver City PD Policy Manual

Use of Force

In addition, when reasonable, officers should evaluate the totality of circumstances presented at the time in each situation and, when feasible, consider and utilize reasonably available alternative tactics and techniques that may persuade an individual to voluntarily comply or may mitigate the need to use a higher level of force to resolve the situation before applying force (Government Code § 7286(b)). Such alternatives may include but are not limited to:

1. Attempts to de-escalate a situation, including those tactics described in Section 300.3.8 below.
2. If reasonably available, the use of crisis intervention techniques by properly trained personnel.
3. Less lethal options.

300.3.8 DE-ESCALATION CONSIDERATIONS AND TECHNIQUES

When time and circumstances reasonably permit, officers shall consider whether an individual's lack of compliance is a deliberate attempt to resist or is the result of an inability to comply based on factors including, but not limited to:

- Medical conditions
- Mental impairment
- Developmental disability
- Physical limitation
- Language barrier
- Drug interaction
- Behavioral crisis

An officer's awareness of these potential contributing factors should then be balanced against the facts of the incident and which tactical options are the most appropriate to bring the situation to a safe resolution. An officer is not expected to engage in force de-escalation measures that could jeopardize the safety of the community or of any employee.

Where circumstances and time reasonably permit, officers should consider de-escalation tactics, including but not limited to:

- Decreasing the exposure to the potential threat by using distance or physical barriers between an uncooperative individual and an officer.
- Containing the threat.
- Maximizing the use of cover or concealment to reduce officer(s) exposure to potential threats by placing the officer(s) in a safer position.
- Communicating from a safe position to gain the individual's compliance through the use of verbal persuasion, advisements, and/or warnings. Generally, communication techniques should engage active listening to calm agitated individuals and promote rational decision-making.

Culver City Police Department

Culver City PD Policy Manual

Use of Force

- The officer's physical actions may also de-escalate a potentially volatile/violent situation; i.e., exhibiting a relaxed body language.

When the circumstances warrant an application of force, the level of force applied must reflect the totality of the reasonably known circumstances surrounding the immediate situation. The officer need only select a level of force that is within the range of "objectively reasonable" options. Officers must rely on training, experience, and an assessment of the situation to decide on an appropriate level of force to be applied. Reasonable and sound judgment will dictate the force option to be employed.

Officers may either escalate or de-escalate the use of force as the situation progresses or as circumstances change. When an individual is under control, either through the application of physical restraint or the individual's compliance, the degree of force shall be de-escalated accordingly. An officer has the duty to intercede when observing unreasonable, excessive, or unnecessary force being applied to a given situation by any public safety officials responding to the incident.

300.3.9 ADDITIONAL RESTRICTIONS

Terms such as "positional asphyxia," "restraint asphyxia," and "excited delirium" continue to remain the subject of debate among experts and medical professionals, are not universally recognized medical conditions, and frequently involve other collateral or controlling factors such as narcotics or alcohol influence or pre-existing medical conditions. While it is impractical to restrict an officer's use of reasonable control methods when attempting to restrain a combative individual, officers are not authorized to use any restraint or transportation method which might unreasonably impair an individual's breathing or respiratory capacity for a period beyond the point when the individual has been adequately and safely controlled. Once the individual is safely secured, officers should promptly check and continuously monitor the individual's condition for signs of medical distress (Government Code § 7286.5).

300.4 DEFINITIONS

Definitions related to this policy include:

Deadly force - Any use of force that creates a substantial risk of causing death or serious bodily injury, including but not limited to the discharge of a firearm (Penal Code § 835a).

Feasible - Reasonably capable of being done or carried out under the circumstances to successfully achieve the arrest or lawful objective without increasing risk to the officer or another person (Government Code § 7286(a)).

Force - The application of physical techniques or tactics, chemical agents, or weapons to another person. It is not a use of force when a person allows themselves to be searched, escorted, handcuffed, or restrained.

Objectively reasonable - Officers must make split-second decisions on the use of force in circumstances that are tense, uncertain, and rapidly evolving. Reasonableness of force is based on the totality of circumstances known by the officer at the time force was used. This is an objective

Culver City Police Department

Culver City PD Policy Manual

Use of Force

standard to be judged from the perspective of a reasonable officer in the moment rather than with the benefit of hindsight.

There are many components that factor into defining an objectively reasonable decision to use force, including:

- The purpose of the use of force (was it lawful?)
- Efforts to de-escalate the situation
- The proportionality of force used to force encountered
- The nature and seriousness of the threat encountered
- Whether the officer's actions unnecessarily or recklessly escalated the situation

Serious bodily injury - A serious impairment of physical condition, including but not limited to the following: loss of consciousness; concussion; bone fracture; protracted loss or impairment of function of any bodily member or organ; a wound requiring extensive suturing; and serious disfigurement (Penal Code § 243(f)(4)).

Totality of the circumstances - All facts known to the officer at the time, including the conduct of the officer and the individual leading up to the use of force (Penal Code § 835a).

300.4.1 INDIVIDUAL BEHAVIOR DEFINITIONS

Cooperative: Complies with all requests and commands made by officers.

Verbally Non-Compliant: Argumentative; questions an officer's authority and reasons for an officer's request of a person to do something.

Verbally Combative or Threatening: Verbally abusive, belligerent, and/or making threats of violence towards officers in the performance of their duties.

Passive Resistance: Ignores an officer's commands. Does not acknowledge an officer's presence. Refuses to move or allow an officer to physically direct to another location.

Active Resistance: Does not follow verbal commands and physically resists attempts by an officer to take physical control.

Assaultive/High Risk: Violent physical resistance and/or assault that could lead to the harm or injury of an officer or others, up to and including serious bodily injury or death.

300.5 USE OF FORCE OPTIONS

Any peace officer may use objectively reasonable force to effect an arrest, to prevent escape, or to overcome resistance. (See section 300.3.1) Though the Force Options listed below range from the lowest level of force to the greatest level of force, nothing in this policy shall require an officer to attempt to use each option in the order listed when confronted by a given threat, a violent individual, or a dangerous situation. Rather, the officer may begin to address the perceived threat, given the totality of the circumstances, with the most reasonable and appropriate force option available to overcome the level of resistance they may encounter.

Culver City Police Department

Culver City PD Policy Manual

Use of Force

Force options available:

- **Officer Presence:** The mere presence of a clearly identifiable police officer, and/or marked police vehicle.
- **Verbal Direction:** Clear, lawful, and understandable verbal direction by an officer directed at an individual in order to gain compliance.
- **Directing of Firearms:** The directing of a firearm toward an individual in order to gain compliance, based on the perceived threat and/or the totality of the circumstances.
- **Physical Control Techniques:** Physical intervention and/or physical control of an individual. This may include leading or moving an individual from a location and the normal application of handcuffs and/or other restraint devices.
- **Pain Compliance Techniques:** Manipulation of an individual's joints or activating certain pressure points to create sufficient pain to achieve compliance.
- **Personal Weapons:** Striking methods performed by an officer (including kicks, punches, knees, and/or elbows) against an individual.
- **Intermediate Weapons:** The use of batons, expandable batons, conducted energy weapons (i.e. Taser or similar device), oleoresin capsicum (OC) spray, pepper balls, kinetic energy projectiles, or canines (K9).
- **Lethal or Deadly Force:** Any use of force that creates a substantial risk of causing death or serious bodily injury, including, but not limited to, the discharge of a firearm. (Penal Code 835a)

300.6 DEADLY FORCE APPLICATIONS

Where feasible, the officer shall, prior to the use of deadly force, make reasonable efforts to identify themselves as a peace officer and to warn that deadly force may be used, unless the officer has objectively reasonable grounds to believe the person is aware of those facts (Penal Code § 835a).

If an objectively reasonable officer would consider it safe and feasible to do so under the totality of the circumstances, officers shall evaluate and use other reasonably available resources and techniques when determining whether to use deadly force. To the extent that it is reasonably practical, officers should consider their surroundings and any potential risks to bystanders prior to discharging a firearm (Government Code § 7286(b)).

The use of deadly force is only justified when the officer reasonably believes it is necessary in the following circumstances (Penal Code § 835a):

- (a) An officer may use deadly force to protect themselves or others from what the officer reasonably believes is an imminent threat of death or serious bodily injury to the officer or another person.
- (b) An officer may use deadly force to apprehend a fleeing person for any felony that threatened or resulted in death or serious bodily injury, if the officer reasonably believes that the person will cause death or serious bodily injury to another unless immediately apprehended.

Culver City Police Department

Culver City PD Policy Manual

Use of Force

Officers shall not use deadly force against a person based on the danger that person poses to themselves, if an objectively reasonable officer would believe the person does not pose an imminent threat of death or serious bodily injury to the officer or to another person (Penal Code § 835a).

Additionally, an officer shall not use deadly force against a person whose actions are a threat solely to property unless the person poses an imminent danger of death or serious physical injury to the officer or others in close proximity.

An "imminent" threat of death or serious bodily injury exists when, based on the totality of the circumstances, a reasonable officer in the same situation would believe that a person has the present ability, opportunity, and apparent intent to immediately cause death or serious bodily injury to the officer or another person. An officer's subjective fear of future harm alone is insufficient as an imminent threat. An imminent threat is one that from appearances is reasonably believed to require instant attention (Penal Code § 835a).

300.6.1 SHOOTING AT OR FROM MOVING VEHICLES

Shots fired at or from a moving vehicle are rarely effective and involve considerations and risks in addition to the justification for the use of deadly force. When feasible, officers should take reasonable steps to move out of the path of an approaching vehicle instead of discharging their firearm at the vehicle or any of its occupants. An officer should only discharge a firearm at a moving vehicle or its occupants when the officer reasonably believes there are no other reasonable means available to avert the imminent threat of the vehicle, or if deadly force other than the vehicle is directed at the officer or others (Government Code § 7286(b)).

Officers should not shoot at any part of a vehicle in an attempt to disable the vehicle.

300.6.2 DISPLAYING AND DIRECTING OF FIREARMS

Given that individuals might perceive the display of a firearm as a potential application of force, officers should carefully evaluate each tactical situation and use sound discretion when drawing a firearm in public by considering the following guidelines (Government Code § 7286(b)):

- (a) **Displaying of Firearms:** If the officer does not initially perceive a threat but reasonably believes that the potential for such threat exists, firearms should generally be kept in the low-ready or other position not directed toward an individual.
- (b) **Directing of Firearms:** If the officer reasonably believes that a threat exists based on the totality of circumstances presented at the time (e.g., high-risk stop, tactical entry, armed encounter), firearms may be drawn and directed toward such threats and/or individual(s) until the officer no longer perceives such threat.
 1. In the event that a directing of firearms toward an individual occurs (as described in Section 300.6.2(b)), the officer(s) shall document the incident promptly, completely, and accurately in an appropriate report, depending on the nature of the incident. The officer should articulate the factors perceived and why they believed the directing of firearms toward the individual(s) was reasonable under the circumstances. Officers are encouraged to review any captured mobile audio/video (MAV) and/or body-worn camera (BWC) footage related to any display of firearms they are required to document.

Culver City Police Department

Culver City PD Policy Manual

Use of Force

2. In the event that a directing of firearms toward an individual occurs (as described in Section 300.6.2(b)), supervisors shall investigate the reported incident in the same manner described in Section 300.7.)

Once it is reasonably safe to do so, officers should carefully secure all firearms.

300.7 SUPERVISOR RESPONSIBILITY

A supervisor should respond to any reported use of force, if reasonably available. The responding supervisor is expected to (Government Code § 7286(b)):

- (a) Obtain the basic facts from the involved officers. Absent an allegation of misconduct or excessive force, this will be considered a routine contact in the normal course of duties.
- (b) Ensure that any injured parties are examined and treated.
- (c) When possible, separately obtain a recorded interview with the subject upon whom force was applied. If this interview is conducted without the person having voluntarily waived his/her *Miranda* rights, the following shall apply:
 1. The content of the interview should not be summarized or included in any related criminal charges.
 2. The fact that a recorded interview was conducted should be documented in a supervisor's log entry, property or other report.
 3. The recording of the interview should be distinctly marked for retention until all potential for civil litigation has expired.
- (d) Once any initial medical assessment has been completed or first aid has been rendered, ensure that photographs have been taken of any areas involving visible injury or complaint of pain, as well as overall photographs of uninjured areas. These photographs should be retained until all potential for civil litigation has expired.
- (e) Identify any witnesses not already included in related reports.
- (f) Review and approve all related reports.
- (g) Review any captured MAV and/or BWC footage related to the incident.
- (h) Determine if there is any indication that the subject may pursue civil litigation.
 1. If there is an indication of potential civil litigation, the supervisor should complete and route a notification of a potential claim through the appropriate channels.
- (i) Evaluate the circumstances surrounding the incident and initiate an administrative investigation if there is a question of policy non-compliance or if for any reason further investigation may be appropriate.
- (j) Make appropriate notifications of the use of force up the chain of command.

In the event that a supervisor is unable to respond to the scene of an incident involving the reported application of force, the supervisor is still expected to complete as many of the above items as circumstances permit.

Culver City Police Department

Culver City PD Policy Manual

Use of Force

300.7 REPORTING THE USE OF FORCE

Any use of force by a member of this department shall be documented promptly, completely, and accurately in an appropriate report, depending on the nature of the incident. The officer should articulate the factors perceived and why they believed the use of force was reasonable under the circumstances. Officers are encouraged to review any captured MAV and/or BWC footage related to any use of force they are required to document.

To collect data for purposes of training, resource allocation, analysis, and related purposes, the Department may require the completion of additional report forms, as specified in department policy, procedure, or law. (See Section 324 Report Preparation for additional circumstances that may require documentation.)

300.7.1 NOTIFICATION TO SUPERVISORS

Any use of force by an officer shall be reported immediately to a supervisor, including but not limited to the following circumstances (Penal Code § 832.13):

- (a) The application caused a visible injury.
- (b) The application would lead a reasonable officer to conclude that the individual may have experienced more than momentary discomfort.
- (c) The individual subjected to the force complained of injury or continuing pain.
- (d) The individual indicates intent to pursue litigation.
- (e) Any application of a conducted energy device or control device.
- (f) Any application of a restraint device other than handcuffs, shackles, or belly chains.
- (g) The individual subjected to the force was rendered unconscious.
- (h) An individual was struck or kicked.
- (i) An individual alleges unreasonable force was used or that any of the above has occurred.

As used in this subsection, "immediately" means as soon as it is safe and feasible to do so.

300.7.2 REPORTING TO CALIFORNIA DEPARTMENT OF JUSTICE

Statistical data regarding all officer-involved shootings and incidents involving use of force resulting in serious bodily injury is to be reported to the California Department of Justice as required by Government Code § 12525.2. (See Section 803 Records Section.)

300.7.3 REPORT RESTRICTIONS

Officers shall not use the term "excited delirium" to describe an individual in an incident report. Officers may describe the characteristics of an individual's conduct, but shall not generally describe the individual's demeanor, conduct, or physical and mental condition at issue as "excited delirium" (Health and Safety Code § 24402).

Culver City Police Department

Culver City PD Policy Manual

Use of Force

300.9 MEDICAL CONSIDERATION

Once it is reasonably safe to do so, properly trained officers should promptly provide or procure medical assistance for any person injured or claiming to have been injured in a use of force incident (Government Code § 7286(b)).

Prior to booking or release, medical assistance shall be obtained for any person who exhibits signs of physical distress, who has sustained visible injury, expresses a complaint of injury or continuing pain, or who was rendered unconscious. Any individual exhibiting signs of physical distress after an encounter should be continuously monitored until he/she can be medically assessed.

Based upon the officer's initial assessment of the nature and extent of the subject's injuries, medical assistance may consist of examination by fire personnel, paramedics, hospital staff, or medical staff at the jail. If any such individual refuses medical attention, such a refusal shall be fully documented in related reports and, whenever practicable, should be witnessed by another officer and/or medical personnel. If a recording is made of the contact or an interview with the individual, any refusal should be included in the recording, if possible.

In the event of head injury or any other obvious serious injury, emergency medical treatment shall be summoned, regardless of any refusals made by the individual.

The on-scene supervisor or, if the on-scene supervisor is not available, the primary handling officer shall ensure that any person providing medical care or receiving custody of a person following any use of force is informed that the person was subjected to force. This notification shall include a description of the force used and any other circumstances the officer reasonably believes would be potential safety or medical risks to the subject (e.g., prolonged struggle, extreme agitation, impaired respiration).

Persons who exhibit extreme agitation, violent irrational behavior accompanied by profuse sweating, extraordinary strength beyond their physical characteristics and imperviousness to pain (sometimes called "excited delirium"), or who require a protracted physical encounter with multiple officers to be brought under control, may be at an increased risk of sudden death. Calls involving these persons should be considered medical emergencies. Officers who reasonably suspect a medical emergency should request medical assistance as soon as practicable and have medical personnel stage away if appropriate.

See the Medical Aid and Response Policy for additional guidelines.

300.10 TRAINING

Officers, investigators, and supervisors will receive annual training on this policy and demonstrate their knowledge and understanding (Government Code § 7286(b)).

300.10.1 TRAINING REQUIREMENTS

Required annual training shall include:

- (a) Legal updates.
- (b) De-escalation tactics, including alternatives to force.

Culver City Police Department

Culver City PD Policy Manual

Use of Force

- (c) The duty to intercede.
- (d) The duty to request and/or render medical aid.
- (e) Warning shots (see the Firearms Policy).
- (f) All other subjects covered in this policy (e.g., use of deadly force, chokeholds and carotid holds, discharge of a firearm at or from a moving vehicle, verbal warnings).
- (g) Training courses required by and consistent with POST guidelines set forth in Penal Code § 13519.10.

See the Training Policy for restrictions relating to officers who are the subject of a sustained use of force complaint.

300.10.2 STATE-SPECIFIC TRAINING REQUIREMENTS

Required state-specific training shall include guidelines regarding vulnerable populations, including but not limited to children, elderly persons, pregnant individuals, and individuals with physical, mental, and developmental disabilities (Government Code § 7286(b)).

300.11 USE OF FORCE COMPLAINTS

The receipt, processing, and investigation of civilian complaints involving use of force incidents should be handled in accordance with the Personnel Complaints Policy (Government Code § 7286(b)).

300.12 POLICY REVIEW

The Chief of Police or the authorized designee should regularly review and update this policy to reflect developing practices and procedures (Government Code § 7286(b)).

300.13 PUBLIC RECORDS REQUESTS

Requests for public records involving an officer's personnel records shall be processed in accordance with Penal Code § 832.7 and the Personnel Records and Records Maintenance and Release policies (Government Code § 7286(b)).

300.14 POLICY AVAILABILITY

The Chief of Police or their authorized designee shall ensure this policy is accessible to the public (Government Code § 7286(c)).

Use of Force Review

301.1 PURPOSE AND SCOPE

This policy establishes a process for the Culver City Police Department to review the use of force and deadly force by its employees.

This review process shall be in addition to any other review or investigation that may be conducted by any outside or multi-agency entity having jurisdiction over the investigation or evaluation of the use of deadly force.

301.2 POLICY

The Culver City Police Department will objectively evaluate the use of force and/or use of deadly force by its members to ensure that their authority is used lawfully, appropriately and is consistent with training and policy.

301.3 USE OF FORCE REVIEW

Any reported use of force shall be investigated by the involved officer's immediate on-duty supervisor in compliance with policy set forth in section 300 of this manual ("Use of Force"). The investigating supervisor will immediately respond to the scene (whenever possible) and thoroughly document the incident and the force used (observant of Government Code sections 3300-3312) on a Supervisor's Log entry. The Supervisor's Log entry and all related materials (i.e. photographs, audio recordings) will be entered into the department's Use of Force database (currently IA Pro/BlueTeam) and forwarded through the chain of command to the respective bureau commander for review.

At each level of management review, the incident will be scrutinized for accuracy and thoroughness and shall be classified by one of the following dispositions before being sent on to the next level of review:

- Based on review of present facts of the incident, force was reasonable, necessary, and within policy.
- Referred to Professional Standards Unit (PSU) for investigation. (See section 1008.6, Administrative Investigations.)
- Force within policy; training issue identified, referred to supervisor and/or Personnel and Training Section.
- Force within policy. Additional and/or unrelated violations of Department policy identified. Referred to supervisor.

Final review and disposition of the use of force incident shall be the responsibility of the respective bureau commander.

The Use of Force Review is intended to confirm that the force that was used (and the circumstances that led up to it) were reasonable, necessary, and justifiable. However, the Use of Force Review may also reveal acts of negligence, misconduct, failures to observe established

Culver City Police Department

Culver City PD Policy Manual

Use of Force Review

methods and protocols, and/or the necessity to establish methods and protocols through training. (For examples, see Section 322 Standards of Conduct.)

Watches, Schedules, & Rotation

302.1 PURPOSE AND SCOPE

This policy provides guidelines and descriptions of the Department's watch schedules and rotation of personnel.

302.1.1 WATCHES

Watch Defined: A Watch shall be that period of time when a particular Bureau, Section, Unit, or Detail is considered to be on-duty.

Hours of Watch: Each Bureau Commander or officer in charge of a Section, Unit, or Detail, shall establish the hours of duty for the watches under his command, subject to the approval of the Chief of Police.

302.1.2 WATCH DESIGNATION: BASIC OPERATIONS PLAN

The following Watch title designations shall be used for designating the basic Patrol Bureau watch plan of the Department. Bureau Commanders may alter the hours of the basic watch plan to accommodate particular needs when approved by the Chief of Police:

- (a) **Day Watch:** 0700 hours to 1930 hours
- (b) **Night Watch:** 1200 hours to 0030 hours
- (c) **Morning Watch:** 1900 hours to 0730 hours

302.1.3 CHANGE OF WATCH

Change of Watch is that time at which the responsibility for the operation of a Bureau, Section, Unit, or Detail, passes from one watch to another. It may be preceded by a briefing period for the watch coming on duty.

302.1.4 WATCH ROTATION: PATROL BUREAU

The Watch Rotation Plan for sworn personnel and jailers assigned to the Patrol Bureau should conform to the following guidelines:

- (a) The established order of watches is Day Watch, Night Watch, Morning Watch.
- (b) Each jailer, officer, sergeant, and lieutenant may be required to work a minimum of four months on a watch. They will then be given an opportunity to choose their assigned shift/watch and days off (from what is available) based on seniority. If they have worked at least one rotation on a given watch, each jailer, officer, sergeant, and lieutenant will be able to bump the most senior person of equal rank on the next watch. (senior officer, jailer or sergeant shall refer to the employee who has the most time on his particular watch.)
- (c) The personnel being bumped shall be transferred to the next watch, in rotation. For example: Officer "Jones" on Night Watch would bump Officer "Smith" on Morning Watch, who would, in turn, bump Officer "Wilson" on Day Watch ". In the event an equal number of personnel request rotation, the "bumping" provision of this section would not apply.

Culver City Police Department

Culver City PD Policy Manual

Watches, Schedules, & Rotation

- (d) Probationary officers may be rotated at any time, according to the needs of the Department.
- (e) Officers assigned to field training may be rotated at any time, according to their training needs as determined by the Department.
- (f) Officers, jailers and lieutenants should rotate in a clockwise direction. (Morning Watch to Day Watch to Night Watch) Sergeants shall rotate in a counter-clockwise direction. (Morning Watch to Night Watch to Day Watch)

While the above is a guideline, nothing shall prohibit the Chief of Police (or his designee) from deviating from this rotation plan in order to satisfy department and employee needs.

302.1.5 WATCH ROTATION: LITIGATION LIAISON AND DOCUMENTS SECTION (RECORDS) CLERKS

The following guidelines should be implemented in the Watch Rotation Plan for personnel assigned to the Litigation Liaison and Documents (Records) Section.

- (a) The established order of watch rotation is to be Morning to Day to Night Watch.
- (b) Each Litigation Liaison and Documents Section Clerk may be required to work a minimum of four months on a watch. They will then be given an opportunity to bump the senior Litigation Liaison and Documents Section Clerk on the next watch. ("Senior" shall refer to the Litigation Liaison and Documents Section Clerk who has the most time on that particular watch.)
- (c) Litigation Liaison and Documents Section Clerks shall be allowed to rotate three times a year. Requests for watch changes shall be made prior to February 1, June 1, and October 1. Watch changes shall then be made on or about these dates.
- (d) Exceptions to the mandatory rotation may be made by the Bureau Commander, with adequate justification on the part of the employee, such as school commitments or personal hardship.
- (e) An employee who is being "bumped" from a watch may, with the approval of a supervisor, attempt to obtain a volunteer from his watch (or if no one volunteers, from another watch) to replace him in the rotation plan. The employee remaining on the watch would then revert to being senior on his particular watch.
- (f) Employees desiring to rotate in a manner other than described, may, with the approval of the Bureau Commander, make arrangements to trade watches with an employee on the watch to which they wish to be transferred.
- (g) Employees assigned to field training may be required to work various watches to facilitate their training.

Nothing shall prohibit the Chief of Police from deviating from the Watch Rotation Plan in order to satisfy Departmental needs.

302.1.6 ASSIGNMENT ROTATION: SPECIAL OPERATIONS BUREAU

The following guidelines should be implemented in the Watch Rotation Plan for personnel assigned to the Special Operations Bureau.

Culver City Police Department

Culver City PD Policy Manual

Watches, Schedules, & Rotation

- (a) Detective positions should be limited to a period of three years.
- (b) Detective Senior Lead positions should be limited to a period of five years.
- (c) Detective Supervisor positions should be limited to a period of two years.
- (d) Detectives assigned to Regional Task Forces should be limited to a period of five years.
- (e) Lieutenant positions should be limited to a period of two years.
- (f) Bureau Commander positions should be limited to a period of two years.

While the above is a guideline, nothing shall prohibit the Chief of Police (or designee) from deviating from this rotation plan in order to satisfy department and employee needs.

302.1.7 ASSIGNMENT ROTATION: TRAFFIC SECTION

The following guidelines should be implemented in the Watch Rotation Plan for personnel assigned to the Traffic Section.

- (a) Accident Investigator position should be limited to three years.
- (b) Motorcycle Officer positions should be limited to a period of three years.
- (c) Commercial Enforcement Officers should be limited to a period of five years.
- (d) Traffic Officers should be limited to a period of three years.
- (e) The Special Operations Lieutenant and Traffic Sergeant should be limited to a period of two years.

While the above is a guideline, nothing shall prohibit the Chief of Police (or designee) from deviating from this rotation plan in order to satisfy department and employee needs.

Handcuffing and Restraints

303.1 PURPOSE AND SCOPE

This policy provides guidelines for the use of handcuffs and other restraints during detentions and arrests.

303.2 POLICY

The Culver City Police Department authorizes the use of restraint devices in accordance with this policy, the Use of Force Policy, and department training. Restraint devices shall not be used to punish, to display authority, or as a show of force.

303.3 USE OF RESTRAINTS

Only members who have successfully completed Culver City Police Department-approved training on the use of restraint devices described in this policy are authorized to use these devices.

When deciding whether to use any restraint, officers should carefully balance officer safety concerns with factors that include but are not limited to:

- The circumstances or crime leading to the arrest.
- The demeanor and behavior of the arrested person.
- The age and health of the person.
- Whether the person is known to be pregnant.
- Whether the person has a hearing or speaking disability. In such cases, consideration should be given, safety permitting, to handcuffing to the front in order to allow the person to sign or write notes.
- Whether the person has any other apparent disability.

303.3.1 RESTRAINT OF DETAINEES

Situations may arise where it may be reasonable to restrain a person who may, after brief investigation, be released without arrest. Unless arrested, the use of restraints on detainees should continue only for as long as is reasonably necessary to ensure the safety of officers and others. When deciding whether to remove restraints from a detainee, officers should continuously weigh the safety interests at hand against the continuing intrusion upon the detainee.

303.3.2 RESTRAINT OF PREGNANT PERSONS

Persons who are known to be pregnant should be restrained in the least restrictive manner that is effective for officer safety. Leg restraints, waist chains, or handcuffs behind the body should not be used unless the officer has a reasonable suspicion that the person may resist, attempt escape, injure themselves or others, or damage property.

No person who is in labor, delivery, or recovery after delivery shall be handcuffed or restrained except in extraordinary circumstances, and only when a supervisor makes an individualized determination that such restraints are necessary for the safety of the detainee, officers, or others

Culver City Police Department

Culver City PD Policy Manual

Handcuffing and Restraints

(Penal Code § 3407; Penal Code § 6030). See the Transporting Persons in Custody Policy for guidelines relating to transporting pregnant persons.

303.3.3 RESTRAINT OF JUVENILES

A juvenile under 14 years of age should not be restrained unless he/she is suspected of a dangerous felony or when the officer has a reasonable suspicion that the juvenile may resist, attempt escape, injure him/herself, injure the officer, or damage property.

303.3.4 NOTIFICATIONS

Whenever an officer transports a person with the use of restraints other than handcuffs, the officer shall inform the jail staff upon arrival at the jail that restraints were used. This notification should include information regarding any other circumstances the officer reasonably believes would be potential safety concerns or medical risks to the person (e.g., prolonged struggle, extreme agitation, impaired respiration) that may have occurred prior to, or during, transportation to the jail.

303.4 APPLICATION OF HANDCUFFS OR PLASTIC CUFFS

Handcuffs, including temporary nylon or plastic cuffs, may be used only to restrain a person's hands to ensure officer safety.

Although recommended for most arrest situations, handcuffing is discretionary and not an absolute requirement of the Department. Officers should consider handcuffing any person they reasonably believe warrants that degree of restraint. However, officers should not conclude that in order to avoid risk every person should be handcuffed, regardless of the circumstances.

In most situations, handcuffs should be applied with the hands behind the person's back. When feasible, handcuffs should be double-locked to prevent tightening, which may cause undue discomfort or injury to the hands or wrists.

In situations where one pair of handcuffs does not appear sufficient to restrain the person or may cause unreasonable discomfort due to the person's size, officers should consider alternatives, such as using an additional set of handcuffs or multiple plastic cuffs.

Handcuffs should be removed as soon as it is reasonable or after the person has been searched and is safely confined within a detention facility.

303.5 APPLICATION OF AUXILIARY RESTRAINT DEVICES

Auxiliary restraint devices include transport belts, waist or belly chains, transportation chains, leg irons, and other similar devices. Auxiliary restraint devices are intended for use during long-term restraint or transportation. They provide additional security and safety without impeding breathing, while permitting adequate movement, comfort, and mobility.

Only department-authorized devices may be used. Any person in auxiliary restraints should be monitored as reasonably appears necessary.

Culver City Police Department

Culver City PD Policy Manual

Handcuffing and Restraints

303.6 LEG RESTRAINT DEVICES

Leg restraint devices may be used to restrain the legs of a violent or potentially violent person when it is reasonable to do so during the course of detention, arrest, or transportation. Officers shall only use department-approved restraining methods when such use appears warranted under the circumstances. Only restraint devices approved by the Department shall be used. Currently, the department authorized leg restraint device is the "RIPP Hobble" device made by RIPP Restraints International, Inc.

303.6.1 DEFINITIONS

- (a) **Leg Restraint Device** - A restraining device used to secure the legs and ankles of an individual.
- (b) **"RIPP" Hobble Device** - A brand-named restraining device made of one-inch wide polypropylene webbed belting with a tested strength of 700 pounds, equipped with a one-inch wide steel, alligator-jawed, friction-locking clip, and a brass or metal snap at one end.

303.6.2 APPLICATION OF LEG RESTRAINT DEVICES

In determining whether to use the leg restraint device, officers should consider:

- (a) Whether the officer or others could be exposed to injury due to the assaultive or resistant behavior of a person.
- (b) Whether it is reasonably necessary to protect the person from his/her own actions (e.g., hitting his/her head against the interior of the patrol vehicle, running away from the arresting officer while handcuffed, kicking at objects or officers).
- (c) Whether it is reasonably necessary to avoid damage to property (e.g., kicking at windows of the patrol vehicle).

303.6.3 GUIDELINES FOR USE OF LEG RESTRAINTS

When applying a leg restraint device, the following guidelines should be followed:

- (a) If practicable, officers should notify a supervisor of the intent to apply the leg restraint device. In all cases, a supervisor shall be notified as soon as practicable after the application of the leg restraint device.
- (b) Once applied, absent a medical or other emergency, the leg restraint device should remain in place until the officer arrives at the jail or other facility or the person no longer reasonably appears to pose a threat.
- (c) Once secured, the person should be placed in a seated or upright position. If placed in a vehicle, the individual should be secured with a seat belt, and shall not be placed on his/her stomach, as this could reduce the person's ability to breathe.
- (d) The restrained person should be continually monitored by an officer while in the leg restraint. The officer should make every reasonable effort to ensure that the person does not roll onto and remain on his/her stomach.
- (e) The officer should look for signs of labored breathing, loss of consciousness, or any other signs of a medical emergency. Officers should take appropriate steps to

Culver City Police Department

Culver City PD Policy Manual

Handcuffing and Restraints

relieve and minimize any obvious factors contributing to this condition, including the immediate removal of the leg restraint device.

- (f) When transported by emergency medical services, the restrained person should be accompanied by an officer when requested by medical personnel. The transporting officer should describe to medical personnel any unusual behaviors or other circumstances the officer reasonably believes would be potential safety or medical risks to the person (e.g., prolonged struggle, extreme agitation, impaired respiration).

303.6.4 LEG RESTRAINT REQUIREMENT

While on-duty, uniformed personnel shall keep leg restraint devices readily available in their police units.

Uniformed personnel may elect to carry the leg restraint device concealed on their person or attached to their duty belt. Plainclothes and non-field personnel may carry the leg restraint device as authorized and in accordance with the needs of their assignment or at the direction of their supervisor.

303.6.5 TOTAL APPENDAGE RESTRAINT POSITION (TARP) PROHIBITED

The use of the Total Appendage Restraint Position (TARP) by members of this Department is strictly prohibited. Under no circumstances shall a leg restraint device be fastened to a restrained person's handcuffs, belt/waistband, or any other part of their body in order to immobilize them.

303.7 REQUIRED DOCUMENTATION

If an individual is arrested, the use of restraints other than handcuffs shall be documented in the related report. The officer should include, as appropriate:

- (a) The type of restraint and the manner in which it was used.
- (b) The amount of time the suspect was restrained.
- (c) How the suspect was transported and the position of the suspect.
- (d) Observations of the suspect's behavior and any signs of physiological problems.
- (e) Any known or suspected drug use or other medical problems.

303.8 TRAINING

The Personnel and Training Lieutenant should ensure that officers receive periodic training on the proper use of handcuffs and other restraints, including:

- (a) Proper placement and fit of handcuffs and other restraint devices approved for use by the Department.
- (b) Response to complaints of pain by restrained persons.
- (c) Options for restraining those who may be pregnant without the use of leg restraints, waist chains, or handcuffs behind the body.
- (d) Options for restraining amputees or those with medical conditions or other physical conditions that may be aggravated by being restrained.

Culver City Police Department

Culver City PD Policy Manual

Handcuffing and Restraints

- (e) Proper placement of safely secured persons into an upright or seated position to avoid placement on the stomach for an extended period, as this could reduce the person's ability to breathe.

Control Devices- Impact Weapons

304.1 PURPOSE AND SCOPE

This policy provides guidelines for the use and maintenance of control devices (Impact Weapons) that are described in this policy.

304.2 POLICY

In order to control subjects who are violent or who demonstrate the intent to be violent, the Culver City Police Department authorizes officers to use impact weapons in accordance with the guidelines in this policy and the Use of Force Policy.

304.3 USER RESPONSIBILITIES

All normal maintenance, charging, or cleaning shall remain the responsibility of personnel using the various devices. Any damaged, inoperative, outdated, or expended control devices or munitions, along with documentation explaining the cause of the damage, shall be returned to the Rangemaster for disposition. An IDC documenting any damage to city property shall also be prepared and forwarded through the chain of command, when appropriate, explaining the cause of damage.

304.4 RANGEMASTER RESPONSIBILITIES

The Rangemaster (and/or ERT Armorer) shall control the inventory of all impact weapons and shall ensure that all damaged, inoperative, outdated, or expended control devices or munitions are properly disposed of, repaired, or replaced.

Every control device will be periodically inspected by the Rangemaster or the designated instructor for a particular control device. The inspection shall be documented and forwarded up the Chain of Command.

304.5 AUTHORIZED BATONS

(a) Straight baton constructed of wood, 26 to 29 inches in length. The baton shall be 1 and 1/8" to 1 and 1/4" inches in diameter and shall be equipped with a black rubber grommet positioned approximately seven inches from one end of the baton. The baton shall be either black or brown (natural wood) in color. It shall also be smooth (sanded) in texture

(b) ASP friction lock baton, 16,21,26, or 31 inches in length. The ASP shall be black or silver/chrome in color.

While working in a patrol capacity, Officers and Sergeants shall always have a straight baton inside their assigned vehicle readily available for use in the field. If carried on the person, all batons shall be carried in their respective holders. Batons shall not be modified in any way. Officers shall only carry those types of batons for which they have been properly trained.

Culver City Police Department

Culver City PD Policy Manual

Control Devices- Impact Weapons

304.6 BATON GUIDELINES AND AUTHORIZED USE

The baton is authorized for use when based upon the circumstances perceived by the sworn officer; such force reasonably appears justified and necessary to result in the safe control of the suspect. The need to immediately control a suspect must be weighed against the risk of causing serious injury. The head, neck, throat, spine, heart, kidneys, and groin should not be intentionally targeted except when the officers reasonably believe the suspect poses an imminent threat of serious bodily injury or death to the officer or others. The use of the baton shall be in compliance with Department Policy 300 (Use of Force), as well as federal, state, and local laws and ordinances.

When carrying a baton, uniformed personnel shall carry the baton in its authorized holder on the equipment belt. Plainclothes and non-field personnel may carry the baton as authorized and in accordance with the needs of their assignment or at the direction of their supervisor. While on duty, uniformed personnel shall keep batons readily available in their police units.

304.7 40MM PROJECTILE LAUNCHER

The 40MM Projectile Launcher is not a firearm, but a Less-Lethal system that uses smokeless powder to deliver 40MM Less-Lethal projectile from a safe distance. The Less-Lethal launcher 40MM projectile should be launched from the recommended effective ranges. The Minimum Safe Range is 5 feet/ 1.5 meters. The Maximum Effective Range is 131 feet/ 40 meters.

304.7.1 GUIDELINE FOR USE

To act as, and shall be limited to, a de-escalation and less-lethal option during the following situations:

- (a) Self-destructive, violent, dangerous and/or combative individuals.
- (b) Riot/crowd control and civil unrest incidents when such weapons are deemed necessary to defend against a threat to life or serious bodily injury to any individual, including a peace officer, or to bring an objectively dangerous and unlawful situation safely and effectively under control.
- (c) Potentially vicious animals.
- (d) During department-approved training exercises

Before discharging projectiles, the officer should consider such factors as:

- (a) Distance and angle to target
- (b) Type of munitions employed
- (c) Type and thickness of subject's clothing
- (d) The subject's proximity to others
- (e) The location of the subject
- (f) Whether the subject's actions dictate the need for an immediate response and the use of control devices appears appropriate

Culver City Police Department

Culver City PD Policy Manual

Control Devices- Impact Weapons

A verbal warning of the device's intended use should precede its application unless it would otherwise endanger the safety of officers or when it is not practicable due to the circumstances. The purpose of the warning is to give the individual a reasonable opportunity to voluntarily comply and to warn other officers and individuals that the device is being deployed.

Officers should keep in mind the manufacturer's recommendations and their training regarding effective distances and target areas. Each situation must be evaluated on the totality of circumstances at the time of deployment.

The need to immediately incapacitate the subject must be weighed against the risk of causing serious injury or death. The head and neck should not be intentionally targeted, except when the officer reasonably believes the suspect poses an imminent threat of serious bodily injury or death to the officer or others.

304.7.2 AUTHORIZED USE

- (a) Only those officers who have been trained in the use of Projectile Launchers are authorized to use the Projectile Launchers, in a manner consistent with Department policy.
- (b) Use for dispersal of riotous crowds must first be approved by the Chief of Police
- (c) All other use of Projectile Launchers must first be approved by the on-duty Watch Commander or the on-scene Field Supervisor.
- (d) In compliance with Department Policy 300 (Use of Force) as well as federal, state, and local laws and ordinances.

304.8 PEPPERBALL LAUNCHER

A system that uses high-pressure air to deliver Pelargonic Acid Vanillylamide (PAVA) powder projectiles or inert rounds (similar to a paintball delivery system). This system can launch projectiles at a subject up to 60'. In addition, the system is capable of area saturation up to 150'. Non-lethal option offers law enforcement officers to deliver chemical agents and kinetic energy impacts to subjects in a potentially violent encounter. De-Escalation tools are used to avoid further injuries or lethal options on a subject.

304.8.1 GUIDELINE FOR USE

To act as, and shall be limited to, a de-escalation and less lethal option during the following situations:

- (a) Self-destructive, violent, dangerous and/or combative individuals.
- (b) Riot/crowd control and civil unrest incidents when such weapons are deemed necessary to defend against a threat to life or serious bodily injury to any individual, including a peace officer, or to bring an objectively dangerous and unlawful situation safely and effectively under control.
- (c) Potentially vicious animals.
- (d) During department-approved training exercises.

Culver City Police Department

Culver City PD Policy Manual

Control Devices- Impact Weapons

Before discharging projectiles, the officer should consider such factors as:

- (a) Distance and angle to target
- (b) Type of munitions employed
- (c) Type and thickness of subject's clothing
- (d) The subject's proximity to others
- (e) The location of the subject
- (f) Whether the subject's actions dictate the need for an immediate response and the use of control devices appears appropriate

A verbal warning of the device's intended use should precede its application unless it would otherwise endanger the safety of officers or when it is not practicable due to the circumstances. The purpose of the warning is to give the individual a reasonable opportunity to voluntarily comply and to warn other officers and individuals that the device is being deployed.

Officers should keep in mind the manufacturer's recommendations and their training regarding effective distances and target areas. Each situation must be evaluated on the totality of circumstances at the time of deployment.

The need to immediately incapacitate the subject must be weighed against the risk of causing serious injury or death. The head and neck should not be intentionally targeted, except when the officer reasonably believes the suspect poses an imminent threat of serious bodily injury or death to the officer or others.

304.8.2 AUTHORIZED USE

- (a) Only those officers who have been trained in the use of Projectile Launchers are authorized to use the Projectile Launchers, in a manner consistent with Department policy.
- (b) Use for dispersal of riotous crowds must first be approved by the Chief of Police
- (c) All other use of Projectile Launchers must first be approved by the on-duty Watch Commander or the on-scene Field Supervisor.
- (d) In compliance with Department Policy 300 (Use of Force), as well as federal, state, and local laws and ordinances.

304.9 IMPACT WEAPONS REPORTING GUIDELINES

Any control device application listed in this policy shall be documented in the related incident report and reported to a supervisor pursuant to the Use of Force Policy (300), and fully reviewed in compliance with policy section 301 (Use of force review). In addition, the deployment of any control devices listed in section 704 (Military Equipment) shall also be documented in the yearly Military Use Report.

Culver City Police Department

Culver City PD Policy Manual

Control Devices- Impact Weapons

304.10 TRAINING FOR CONTROL DEVICES- IMPACT WEAPONS

The Personnel and Training Sergeant and Training Coordinator shall ensure that all personnel who are authorized to carry a control device have been properly trained and certified to carry the specific control device and are retrained or recertified as necessary.

- (a) Proficiency training shall be monitored and documented by a certified, control-device weapons or tactics instructor.
- (b) All training and proficiency for control devices will be documented in the officer's training file.
- (c) Officers who fail to demonstrate proficiency with the control device or knowledge of this agency's Use of Force Policy will be provided remedial training. If an officer cannot demonstrate proficiency with a control device or knowledge of this agency's Use of Force Policy after remedial training, the officer will be restricted from carrying the control device and may be subject to discipline.

Conducted Energy Device

305.1 PURPOSE AND SCOPE

This policy provides guidelines for the issuance and use of the conducted energy device (CED).

305.2 POLICY

The CED is used in an attempt to control a violent or potentially violent individual while minimizing the risk of serious injury. The appropriate use of such a device may result in fewer serious injuries to officers and suspects.

305.3 ISSUANCE AND CARRYING CEDS

Only members who have successfully completed department-approved training may be issued and may carry the CED.

The Rangemaster should keep a log of issued CED devices and the serial numbers of cartridges/magazines issued to members.

CEDs are issued for use during a member's current assignment. Those leaving a particular assignment may be required to return the device to the department inventory.

Officers shall only use the CED and cartridges/magazines that have been issued by the Department. Cartridges/magazines should not be used after the manufacturer's expiration date.

Uniformed officers who have been issued the CED shall wear the device in an approved holster.

Members carrying the CED should perform a function test (TASER 10™) or spark check/test (other device models) on the unit prior to every shift.

Officers who carry the CED while in uniform shall carry the CED in a holster on the side opposite the duty weapon (Penal Code § 13660).

- (a) All CEDs shall be clearly distinguishable to differentiate them from the duty weapon and any other device.
- (b) For single-shot devices, whenever practicable, officers should carry an additional cartridge on their person when carrying the CED.
- (c) Officers should not hold a firearm and the CED at the same time.

Non-uniformed officers may secure the CED in a concealed, secure location in the driver's compartment of their vehicles.

305.3.1 USER RESPONSIBILITIES

Officers shall be responsible for ensuring that the issued CED is properly maintained and in good working order. This includes a function test and battery life monitoring, as required by the manufacturer, and should be completed prior to the beginning of the officer's shift.

CEDs that are damaged or inoperative, or cartridges/magazines that are expired or damaged, shall be returned to the Rangemaster for disposition. Officers shall submit documentation stating

Culver City Police Department

Culver City PD Policy Manual

Conducted Energy Device

the reason for the return and how the CED or cartridge/magazine was damaged or became inoperative, if known.

305.4 VERBAL AND VISUAL WARNINGS

A verbal warning of the intended use of the CED should precede its application, unless it would otherwise endanger the safety of officers or when it is not practicable due to the circumstances. The purpose of the warning is to:

- (a) Provide the individual with a reasonable opportunity to voluntarily comply.
- (b) Provide other officers and individuals with a warning that the CED may be deployed.

If, after a verbal warning, an individual fails to voluntarily comply with an officer's lawful orders and it appears both reasonable and feasible under the circumstances, the officer may, but is not required to, activate any warning on the device, which may include the display of the electrical arc, an audible and/or visual warning, or the laser in a further attempt to gain compliance prior to the application of the CED. The laser should not be intentionally directed into anyone's eyes.

The fact that a verbal or other warning was given or the reasons it was not given shall be documented by the officer deploying the CED in the related report.

305.5 USE OF THE CED

The CED has limitations and restrictions requiring consideration before its use. The CED should only be used when its operator can safely deploy the device within its operational range. Although the CED may be effective in controlling most individuals, officers should be aware that the device may not achieve the intended results and be prepared with other options.

If sufficient personnel are available and can be safely assigned, an officer designated as lethal cover for any officer deploying a CED may be considered for officer safety.

305.5.1 APPLICATION OF THE CED

The CED may be used, when the circumstances reasonably perceived by the officer at the time indicate that such application reasonably appears necessary to control a person who:

- (a) Is violent or is physically resisting.
- (b) Has demonstrated, by words or action, an intention to be violent or to physically resist, and reasonably appears to present the potential to harm officers, themselves, or others.

Mere flight from a pursuing officer, without additional circumstances or factors, is not good cause for the use of the CED to apprehend an individual.

The CED shall not be used to psychologically torment, to elicit statements, or to punish any individual.

305.5.2 SPECIAL DEPLOYMENT CONSIDERATIONS

The use of the CED on certain individuals should generally be avoided unless the totality of the circumstances indicates that other available options reasonably appear ineffective or would

Culver City Police Department

Culver City PD Policy Manual

Conducted Energy Device

present a greater danger to the officer, the subject or others, and the officer reasonably believes that the need to control the individual outweighs the potential risk of using the device. This includes:

- (a) Individuals who are known to be pregnant.
- (b) Elderly individuals or obvious juveniles.
- (c) Individuals with obviously low body mass.
- (d) Individuals who are handcuffed or otherwise restrained.
- (e) Individuals known to have been recently sprayed with a flammable chemical agent or who are otherwise known to be in close proximity to any known combustible vapor or flammable material, including alcohol-based oleoresin capsicum (OC) spray.
- (f) Individuals whose position or activity is likely to result in collateral injury (e.g., falls from height, located in water, operating vehicles).

Any CED capable of being applied in the drive-stun mode (i.e., direct contact without probes as a primary form of pain compliance) should be limited to supplementing the probe-mode to complete the circuit, or as a distraction technique to gain separation between officers and the subject, thereby giving officers time and distance to consider other force options or actions.

305.5.3 TARGETING CONSIDERATIONS

Recognizing that the dynamics of a situation and movement of the subject may affect target placement of probes, when practicable, officers should attempt to target the back, lower center mass, and upper legs of the subject, and avoid intentionally targeting the head, neck, area of the heart, or genitals. If circumstances result in one or more probes inadvertently striking an area outside of the preferred target zones, the individual should be closely monitored until examined by paramedics or other medical personnel.

305.5.4 MULTIPLE APPLICATIONS OF THE CED

Once an officer has successfully deployed two probes on the subject, the officer should continually assess the subject to determine if additional probe deployments or cycles reasonably appear necessary. Additional factors officers may consider include but are not limited to:

- (a) Whether it is reasonable to believe that the need to control the individual outweighs the potentially increased risk posed by multiple applications.
- (b) Whether the probes are making proper contact.
- (c) Whether the individual has the ability and has been given a reasonable opportunity to comply.
- (d) Whether verbal commands or other options or tactics may be more effective.

Given that on certain devices (e.g., TASER 10™) each trigger pull deploys a single probe, the officer must pull the trigger twice to deploy two probes to create the possibility of neuro-muscular incapacitation.

Culver City Police Department

Culver City PD Policy Manual

Conducted Energy Device

305.5.5 ACTIONS FOLLOWING DEPLOYMENTS

Officers should take appropriate actions to control and restrain the individual as soon as reasonably practicable to minimize the need for longer or multiple exposures to the CED. As soon as practicable, officers shall notify a supervisor any time the CED has been discharged. If needed for evidentiary purposes, the expended cartridge, along with any probes and wire, should be submitted into evidence (including confetti tags, when equipped on the device). The evidence packaging should be marked "Biohazard" if the probes penetrated the subject's skin.

305.5.6 DANGEROUS ANIMALS

The CED may be deployed against an animal if the animal reasonably appears to pose an imminent threat to human safety.

305.5.7 OFF-DUTY CONSIDERATIONS

Officers are not authorized to carry department CEDs while off-duty.

Officers shall ensure that CEDs are secured while in their homes, vehicles, or any other area under their control, in a manner that will keep the device inaccessible to others.

305.6 DOCUMENTATION

Officers shall document all CED discharges in the related arrest/crime reports and the CED report forms. Photographs should be taken of any obvious probe impact or drive-stun application sites and attached to the CED report form. Notification shall also be made to a supervisor in compliance with the Use of Force Policy. Unintentional discharges, pointing the device at a person, audible warning, laser activation, and arcing the device, other than for testing purposes, will also be documented on the report form. Data downloads from the CED after use on a subject should be done as soon as practicable using a department-approved process to preserve the data.

305.6.1 REPORTS

The officer should include the following in the arrest/crime report:

- (a) Identification of all personnel firing CEDs
- (b) Identification of all witnesses
- (c) Medical care provided to the subject
- (d) Observations of the subject's physical and physiological actions
- (e) Any known or suspected drug use, intoxication, or other medical problems

305.7 MEDICAL TREATMENT

Consistent with local medical personnel protocols and absent extenuating circumstances, only appropriate medical personnel or officers trained in probe removal and handling should remove CED probes from a person's body. Used CED probes shall be treated as a sharps biohazard, similar to a used hypodermic needle, and handled appropriately. Universal precautions should be taken.

Culver City Police Department

Culver City PD Policy Manual

Conducted Energy Device

All persons who have been struck by CED probes or who have been subjected to the electric discharge of the device, or who sustained direct exposure of the laser to the eyes shall be medically assessed prior to booking. Additionally, any such individual who falls under any of the following categories should, as soon as practicable, be examined by paramedics or other qualified medical personnel:

- (a) The person is suspected of being under the influence of controlled substances and/or alcohol.
- (b) The person may be pregnant.
- (c) The person reasonably appears to be in need of medical attention.
- (d) The CED probes are lodged in a sensitive area (e.g., groin, female breast, head, face, neck).
- (e) The person requests medical treatment.

Any individual exhibiting signs of distress or who is exposed to multiple or prolonged applications shall be transported to a medical facility for examination or medically evaluated prior to booking. If any individual refuses medical attention, such a refusal should be witnessed by another officer and/or medical personnel and shall be fully documented in related reports. If an audio/video recording is made of the contact or an interview with the individual, any refusal should be included, if possible.

The transporting officer shall inform any person providing medical care or receiving custody that the individual has been subjected to the application of the CED (see the Medical Aid and Response Policy).

305.8 SUPERVISOR RESPONSIBILITIES

When possible, supervisors should respond to calls when they reasonably believe there is a likelihood the CED may be used. A supervisor should respond to all incidents where the CED was activated.

A supervisor should review each incident where a person has been exposed to a CED. The device's internal logs should be downloaded through the data port by an authorized CED instructor or a supervisor or Rangemaster and saved with the related arrest/crime report. The supervisor should arrange for photographs of probe sites to be taken and witnesses to be interviewed.

305.9 TRAINING

Personnel who are authorized to carry the CED shall be permitted to do so only after successfully completing the initial department-approved training. Any personnel who have not carried the CED as a part of their assignments for a period of one year or more shall be recertified by a qualified CED instructor prior to again carrying or using the device.

Proficiency training for personnel who have been issued CEDs should occur every year. A reassessment of an officer's knowledge and/or practical skills may be required at any time, if deemed appropriate by the Personnel and Training Lieutenant. All training and proficiency for CEDs will be documented in the officer's training files.

Culver City Police Department

Culver City PD Policy Manual

Conducted Energy Device

Command staff, supervisors, and investigators should receive CED training as appropriate for the investigations they conduct and review.

Officers who do not carry CEDs should receive training that is sufficient to familiarize them with the device and with working with officers who use the device.

The Personnel and Training Lieutenant is responsible for ensuring that all members who carry CEDs have received initial and annual proficiency training. Periodic audits should be used for verification.

Application of CEDs during training could result in injuries and should not be mandatory for certification.

The Personnel and Training Lieutenant should include the following training:

- (a) A review of this policy.
- (b) A review of the Use of Force Policy.
- (c) Performing weak-hand draws or cross-draws until proficient to reduce the possibility of unintentionally drawing and firing a firearm.
- (d) Target area considerations, to include techniques or options to reduce the unintentional application of probes to the head, neck, area of the heart, and groin.
- (e) Scenario-based training, including virtual reality training when available.
- (f) Handcuffing a subject during the application of the CED and transitioning to other force options.
- (g) De-escalation techniques.
- (h) Restraint techniques that do not impair respiration following the application of the CED.
- (i) Proper use of cover and concealment during deployment of the CED for purposes of officer safety.
- (j) Proper tactics and techniques related to multiple applications of CEDs.

Officer-Involved Shootings and Deaths

306.1 PURPOSE AND SCOPE

The purpose of this policy is to establish policy and procedures for the investigation of an incident in which a person is injured or dies as the result of an officer-involved shooting or dies as a result of another action of an officer.

In other incidents not covered by this policy, the Chief of Police may decide that the investigation will follow the process provided in this policy.

306.2 POLICY

The policy of the Culver City Police Department is to ensure that officer-involved shootings and deaths are investigated in a thorough, fair and impartial manner.

306.3 TYPES OF INVESTIGATIONS

Officer-involved shootings and deaths involve several separate investigations. The investigations may include:

- A criminal investigation of the suspect's actions.
- A criminal investigation of the involved officer's actions.
- An administrative investigation as to policy compliance by involved officers.
- A civil investigation to determine potential liability.

306.4 CONTROL OF INVESTIGATIONS

Investigators from surrounding agencies may be assigned to work on the criminal investigation of officer-involved shootings and deaths. This may include at least one investigator from the agency that employs the involved officer.

Jurisdiction is determined by the location of the shooting or death and the agency employing the involved officer. The following scenarios outline the jurisdictional responsibilities for investigating officer-involved shootings and deaths.

306.4.1 CULVER CITY POLICE DEPARTMENT OFFICER WITHIN THIS JURISDICTION

With the assistance of Culver City Police Department personnel, the Los Angeles County Sheriff's Department and members from the Los Angeles District Attorney's Office are generally responsible for the criminal investigation of the suspect's and officer's actions surrounding an officer-involved shooting. The Culver City Police Department will conduct the civil investigation and the administrative investigation.

306.4.2 CRIMINAL INVESTIGATION OF OFFICER ACTIONS

The control of the criminal investigation into the involved officer's conduct during the incident will be determined by the employing agency's protocol. When an officer from this department is involved, the criminal investigation will be handled according to the Criminal Investigation section of this policy.

Culver City Police Department

Culver City PD Policy Manual

Officer-Involved Shootings and Deaths

Requests made of this department to investigate a shooting or death involving an outside agency's officer shall be referred to the Chief of Police or the authorized designee for approval.

306.4.3 CULVER CITY POLICE DEPARTMENT OFFICER IN ANOTHER JURISDICTION

With the assistance of Culver City Police Department personnel, the Los Angeles County Sheriff's Department and members from the Los Angeles District Attorney's Office are generally responsible for the criminal investigation of the suspect's and officer's actions surrounding an officer-involved shooting. The Culver City Police Department will conduct the civil investigation and the administrative investigation.

306.4.4 INVESTIGATION RESPONSIBILITY MATRIX

The following table identifies the possible scenarios and responsibilities for the investigation of officer-involved shootings:

	Criminal Investigation of Suspect(s)	Criminal Investigation of Officer(s)	Civil Investigation of	Administrative Investigation
CCPD Officer in This Jurisdiction	LASD/LA Attorney Investigators	Dist. LASD/LA Attorney Investigators	Dist. CCPD Civil Liability Team	CCPD Professional Standards Unit
Allied Agency's Officer in This Jurisdiction	Discretion of Involved Department	Involved Officer's Department	Officer's Involved Department	Officer's Involved Department
CCPD Officer in Another Jurisdiction	LASD/LA Attorney Investigators	Dist. LASD/LA Attorney Investigators	Dist. CCPD Civil Liability Team	CCPD Professional Standards Unit

Note: In the event that an officer of this Department is involved in a shooting outside of Los Angeles County, any criminal investigation will be conducted by the agency having jurisdiction. Any civil or administrative investigation will be handled by this Department's Civil Liability Team and Professional Standards Unit respectively.

306.5 INVESTIGATION PROCESS

The following procedures are guidelines used in the investigation of an officer-involved shooting or death.

306.5.1 UNINVOLVED OFFICER RESPONSIBILITIES

Upon arrival at the scene of an officer-involved shooting, the first uninvolved CCPD officer will be the officer-in-charge and will assume the responsibilities of a supervisor until properly relieved. This officer should, as appropriate:

- (a) Secure the scene and identify and eliminate hazards for all those involved.
- (b) Take reasonable steps to obtain emergency medical attention for injured individuals.
- (c) Request additional resources from the Department or other agencies.
- (d) Coordinate a perimeter or pursuit of suspects.

Culver City Police Department

Culver City PD Policy Manual

Officer-Involved Shootings and Deaths

- (e) Check for injured persons and evacuate as needed.
- (f) Brief the supervisor upon arrival.

306.5.2 WATCH COMMANDER RESPONSIBILITIES

Upon learning of an officer-involved shooting or death, the Watch Commander shall be responsible for coordinating all aspects of the incident until he/she is relieved by the Chief of Police or a Bureau Commander.

All outside inquiries about the incident shall be directed to the Watch Commander.

306.5.3 NOTIFICATIONS

The following person(s) shall be notified as soon as practical:

- Chief of Police
- Assistant Chief of Police
- All Department Bureau Commanders
- The Los Angeles Sheriff's Department Homicide Bureau and Los Angeles County District Attorney's OIS roll-out team
- Professional Standards Unit Lieutenant
- Officer(s) representative(s) (if requested)

All outside inquiries about the incident shall be directed to the Watch Commander.

306.5.4 INVOLVED OFFICERS

Once the involved officer(s) have arrived at the station, the Watch Commander should admonish each officer that the incident shall not be discussed except with authorized personnel or representatives. The following shall be considered for the involved officer:

- (a) Any request for department or legal representation will be accommodated, however, no involved officer shall be permitted to meet collectively or in a group with an attorney or any representative prior to providing a formal interview or report (Government Code § 3303(i)).
- (b) Discussions with licensed attorneys will be considered privileged as attorney-client communications.
- (c) Discussions with department representatives (e.g., employee association) will be privileged only as to the discussion of non-criminal information however.
- (d) A psychotherapist shall be provided by the Department to each involved officer, or any other officer, upon request.
 - 1. Interviews with a licensed psychotherapist will be considered privileged and will not be disclosed except to the extent that the officer is or is not fit for return to duty.

Culver City Police Department

Culver City PD Policy Manual

Officer-Involved Shootings and Deaths

2. An interview or session with a licensed psychotherapist may take place prior to the involved officer providing a formal interview or report, but the involved officers shall not be permitted to consult or meet collectively or in a group with a licensed psychotherapist prior to providing a formal interview or report.

Care should be taken to preserve the integrity of any physical evidence present on the officer's equipment or clothing, such as blood or fingerprints, until investigators or lab personnel can properly retrieve it.

Detectives shall make reasonable accommodations to the officer's physical and emotional needs (Government Code § 3303(d)).

Each involved officer shall be given reasonable paid administrative leave following an officer-involved shooting. It shall be the responsibility of the Watch Commander to make schedule adjustments to accommodate such leave.

306.5.5 SUPERVISOR RESPONSIBILITIES

Upon arrival at the scene, the first uninvolved CCPD supervisor should ensure completion of the duties as outlined above, plus:

- (a) Attempt to obtain a brief overview of the situation from any uninvolved officers.
 1. In the event that there are no uninvolved officers who can supply adequate overview, the supervisor should attempt to obtain a brief voluntary overview from one involved officer.
- (b) If necessary, the supervisor may administratively order any CCPD officer to immediately provide public safety information necessary to secure the scene, identify injured parties and pursue suspects.
 1. Public safety information shall be limited to such things as outstanding suspect information, number and direction of any shots fired, perimeter of the incident scene, identity of known or potential witnesses and any other pertinent information.
 2. The initial on-scene supervisor should not attempt to order any involved officer to provide any information other than public safety information.
- (c) Provide all available information to the Watch Commander and Southbay RCC. If feasible, sensitive information should be communicated over secure networks.
- (d) Take command of and secure the incident scene with additional CCPD members until properly relieved by another supervisor or other assigned personnel or investigator.
- (e) As soon as practicable, ensure that involved officers are transported (separately, if feasible) to a suitable location for further direction.
 1. Each involved CCPD officer should be given an administrative order not to discuss the incident with other involved officers or CCPD members pending further direction from a supervisor.

Culver City Police Department

Culver City PD Policy Manual

Officer-Involved Shootings and Deaths

2. When an involved officer's weapon is taken or left at the scene for other than officer-safety reasons (e.g., evidence), ensure that he/she is provided with a comparable replacement weapon or transported by other officers.

306.5.6 INVOLVED OFFICERS

The following shall be considered for the involved officer:

- (a) Any request for legal or union representation will be accommodated.
 1. Involved CCPD officers shall not be permitted to meet collectively or in a group with an attorney or any representative prior to providing a formal interview or report.
 2. Requests from involved non-CCPD officers should be referred to their employing agency.
- (b) Discussions with licensed attorneys will be considered privileged as attorney-client communications.
- (c) Discussions with agency representatives/employee groups will be privileged only as to the discussion of non-criminal information (Government Code § 3303(i)).
- (d) A licensed psychotherapist shall be provided by the Department to each involved CCPD officer. A licensed psychotherapist may also be provided to any other affected CCPD members, upon request.
 1. Interviews with a licensed psychotherapist will be considered privileged.
 2. An interview or session with a licensed psychotherapist may take place prior to the member providing a formal interview or report. However, involved members shall not be permitted to consult or meet collectively or in a group with a licensed psychotherapist prior to providing a formal interview or report.
 3. A separate fitness-for-duty exam may also be required (see the Fitness for Duty Policy).
- (e) Communications between the involved officer and a peer support member are addressed in the Wellness Program Policy.

Care should be taken to preserve the integrity of any physical evidence present on the involved officer's equipment or clothing, such as blood or fingerprints, until investigators or lab personnel can properly retrieve it.

Each involved CCPD officer shall be given reasonable paid administrative leave following an officer-involved shooting or death. It shall be the responsibility of the Watch Commander to make schedule adjustments to accommodate such leave.

306.5.7 NOTIFICATION TO DEPARTMENT OF JUSTICE

The California Department of Justice (DOJ) is required to investigate an officer-involved shooting resulting in the death of an unarmed civilian. The Watch Commander should promptly notify the DOJ in all incidents involving an officer-involved shooting resulting in the death of an unarmed civilian, including where it is undetermined if the civilian was unarmed.

Culver City Police Department

Culver City PD Policy Manual

Officer-Involved Shootings and Deaths

For purposes of notification, “unarmed civilian” means anyone who is not in possession of a deadly weapon (Government Code § 12525.3).

See attachment: [2021-DOJ_OIS Protocol.pdf](#)

The Watch Commander shall be responsible for ensuring that the DOJ is notified.

306.6 CRIMINAL INVESTIGATION

The District Attorney's Office is responsible for the criminal investigation into the circumstances of any officer-involved shooting or death.

If available, investigative personnel from this department may be assigned to partner with investigators from outside agencies or the District Attorney's Office to avoid duplicating efforts in related criminal investigations.

Once public safety issues have been addressed, criminal investigators should be given the opportunity to obtain a voluntary statement from involved officers and to complete their interviews.

The following shall be considered for the involved officer:

- (a) CCPD supervisors and Professional Standards Unit personnel should not participate directly in any voluntary interview of CCPD officers. This will not prohibit such personnel from monitoring interviews or providing the criminal investigators with topics for inquiry.
- (b) If requested, any involved officer will be afforded the opportunity to consult individually with a representative of the officer's choosing or an attorney prior to speaking with criminal investigators. However, in order to maintain the integrity of each involved officer's statement, involved officers shall not consult or meet with a representative or an attorney collectively or in groups prior to being interviewed.
- (c) If any involved officer is physically, emotionally, or otherwise not in a position to provide a voluntary statement when interviewed by criminal investigators, consideration should be given to allowing a reasonable period for the officer to schedule an alternate time for the interview.
- (d) Any voluntary statement provided by an involved officer will be made available for inclusion in any related investigation, including administrative investigations. However, no administratively coerced statement will be provided to any criminal investigators unless the officer consents.

306.6.1 REPORTS BY INVOLVED CCPD OFFICERS

In the event that suspects remain outstanding or subject to prosecution for related offenses, this department shall retain the authority to require involved CCPD officers to provide sufficient information for related criminal reports to facilitate the apprehension and prosecution of those individuals (Government Code § 3304(a)).

While the involved CCPD officer may write the report, it is generally recommended that such reports be completed by assigned investigators, who should interview all involved officers as victims/witnesses. Since the purpose of these reports will be to facilitate criminal prosecution, statements of involved officers should focus on evidence to establish the elements of criminal

Culver City Police Department

Culver City PD Policy Manual

Officer-Involved Shootings and Deaths

activities by suspects. Care should be taken not to duplicate information provided by involved officers in other reports.

Nothing in this section shall be construed to deprive an involved CCPD officer of the right to consult with legal counsel prior to completing any such criminal report.

Reports related to the prosecution of criminal suspects will be processed according to normal procedures but should also be included for reference in the investigation of the officer-involved shooting or death.

306.6.2 CRIMINAL INVESTIGATION

It shall be the policy of this department to utilize the Los Angeles County Sheriff's Department and the Los Angeles County District Attorney's Office to conduct an independent criminal investigation into the circumstances of any officer-involved shooting involving injury or death.

If available, detective personnel from this department may be assigned to partner with investigators from the Los Angeles County Sheriff's Department and the Los Angeles County District Attorney's Office so as to not duplicate efforts in related criminal investigations.

Once public safety issues have been addressed, criminal investigators will be given the next opportunity to interview involved officers in order to provide them with an opportunity to give a voluntary statement. The following shall be considered for the involved officer:

- (a) Supervisors and Professional Standards Unit personnel should not participate directly in any voluntary interview of officers. This will not prohibit such personnel from monitoring such interviews or indirectly providing areas for inquiry.
- (b) If requested, any involved officer will be afforded the opportunity to consult individually with a representative of his/her choosing or an attorney, prior to speaking with criminal investigators. However, in order to maintain the integrity of each individual officer's statement, involved officers shall not consult or meet with a representative or attorney collectively or in groups prior to being interviewed.
- (c) Any voluntary statement provided by the officer(s) will be made available for inclusion in the administrative or other related investigations.
- (d) Absent consent from the involved officer or as required by law, no administratively coerced statement(s) will be provided to any criminal investigators.

306.6.3 REPORTS BY INVOLVED OFFICERS

In the event that suspects remain outstanding or subject to prosecution for related offenses, this department shall retain the authority to require involved officers to provide sufficient information for related criminal reports to facilitate the apprehension and prosecution of those individuals (Government Code § 3304(a)).

While the involved officer may write the report, it is generally recommended that such reports be completed by assigned investigators who should interview involved officers as victims/witnesses. Since the purpose of these reports will be to facilitate criminal prosecution, statements of involved

Culver City Police Department

Culver City PD Policy Manual

Officer-Involved Shootings and Deaths

officers should focus on evidence to establish the elements of criminal activities by involved suspects. Care should be taken not to duplicate information provided by involved officers in other reports.

Nothing in this section shall be construed to deprive an involved officer of the right to consult with legal counsel prior to completing any such criminal report.

Reports related to the prosecution of criminal suspects will be processed according to normal procedures, but should also be included for reference in the investigation of the officer-involved shooting.

306.6.4 WITNESS IDENTIFICATION AND INTERVIEWS

Because potential witnesses to an officer-involved shooting or death may become unavailable or the integrity of their statements compromised with the passage of time, a supervisor should take reasonable steps to promptly coordinate with criminal investigators to utilize available personnel for the following:

- (a) Identification of all persons present at the scene and in the immediate area.
 - 1. When feasible, a recorded statement should be obtained from those persons who claim not to have witnessed the incident but who were present at the time it occurred.
 - 2. Any potential witness who is unwilling or unable to remain available for a formal interview should not be detained absent reasonable suspicion to detain or probable cause to arrest. Without detaining the individual for the sole purpose of identification, officers should attempt to identify the witness prior to his/her departure.
- (b) Witnesses who are willing to provide a formal interview should be asked to meet at a suitable location where criminal investigators may obtain a recorded statement. Such witnesses, if willing, may be transported by a member of the Department.
 - 1. A written, verbal or recorded statement of consent should be obtained prior to transporting a witness. When the witness is a minor, consent should be obtained from the parent or guardian, if available, prior to transportation.
- (c) Promptly contacting the suspect's known family and associates to obtain any available and untainted background information about the suspect's activities and state of mind prior to the incident.

306.7 ADMINISTRATIVE INVESTIGATION

In addition to all other investigations associated with an officer-involved shooting or death, this department will conduct an internal administrative investigation of CCPD officers to determine conformance with department policy. The investigation will be conducted under the supervision of the Professional Standards Unit and will be considered a confidential officer personnel file.

Culver City Police Department

Culver City PD Policy Manual

Officer-Involved Shootings and Deaths

Interviews of members shall be subject to department policies and applicable laws (see the Personnel Complaints Policy).

- (a) Any officer involved in a shooting or death may be requested or administratively compelled to provide a blood sample for alcohol/drug screening. Absent consent from the officer, such compelled samples and the results of any such testing shall not be disclosed to any criminal investigative agency.
- (b) If any officer has voluntarily elected to provide a statement to criminal investigators, the assigned administrative investigator should review that statement before proceeding with any further interview of that involved officer.
 1. If a further interview of the officer is deemed necessary to determine policy compliance, care should be taken to limit the inquiry to new areas with minimal, if any, duplication of questions addressed in the voluntary statement. The involved officer shall be provided with a copy of his/her prior statement before proceeding with any subsequent interviews.
- (c) In the event that an involved officer has elected to not provide criminal investigators with a voluntary statement, the assigned administrative investigator shall conduct an administrative interview to determine all relevant information.
 1. Although this interview should not be unreasonably delayed, care should be taken to ensure that the officer's physical and psychological needs have been addressed before commencing the interview.
 2. If requested, the officer shall have the opportunity to select an uninvolved representative to be present during the interview. However, in order to maintain the integrity of each individual officer's statement, involved officers shall not consult or meet with a representative or attorney collectively or in groups prior to being interviewed (Government Code § 3303(i)).
 3. Administrative interviews should be recorded by the investigator. The officer may also record the interview (Government Code § 3303(g)).
 4. The officer shall be informed of the nature of the investigation. If an officer refuses to answer questions, he/she should be given his/her *Lybarger* or *Garrity* rights and ordered to provide full and truthful answers to all questions. The officer shall be informed that the interview will be for administrative purposes only and that the statement cannot be used criminally.
 5. The Professional Standards Unit shall compile all relevant information and reports necessary for the Department to determine compliance with applicable policies.
 6. Regardless of whether the use of force is an issue in the case, the completed administrative investigation shall be submitted to the Use of Force Review Board, which will restrict its findings as to whether there was compliance with the Use of Force Policy.
 7. Any other indications of potential policy violations shall be determined in accordance with standard disciplinary procedures.

Culver City Police Department

Culver City PD Policy Manual

Officer-Involved Shootings and Deaths

306.7.1 CIVIL LIABILITY RESPONSE

A member of this department may be assigned to work exclusively under the direction of the legal counsel for the Department to assist in the preparation of materials deemed necessary in anticipation of potential civil litigation.

All materials generated in this capacity shall be considered attorney work product and may not be used for any other purpose. The civil liability response is not intended to interfere with any other investigation, but shall be given reasonable access to all other investigations.

306.8 DEBRIEFING

Following an officer-involved shooting or death, the Culver City Police Department should conduct both a Critical Incident Stress Debriefing and a tactical debriefing. See the Wellness Program Policy for guidance on Critical Incident Stress Debriefings.

306.8.1 TACTICAL DEBRIEFING

A tactical debriefing should take place to identify any training or areas of policy that need improvement. The Chief of Police should identify the appropriate participants. This debriefing should not be conducted until all involved members have provided recorded or formal statements to criminal and/or administrative investigators.

306.9 MEDIA RELATIONS

Any media release shall be prepared with input and concurrence from the supervisor and department representative responsible for each phase of the investigation. Releases will be available to the Watch Commander, Investigations Bureau Bureau Commander and Public Information Officer in the event of inquiries from the media.

The Department shall not subject any involved CCPD officer to visits by the media (Government Code § 3303(e)). No involved CCPD officer shall make any comment to the media unless he/she is authorized by the Chief of Police or a Bureau Commander. Department members receiving inquiries regarding officer-involved shootings or deaths occurring in other jurisdictions shall refrain from public comment and will direct those inquiries to the agency having jurisdiction and primary responsibility for the investigation.

306.10 REPORTING

If the death of an individual occurs in the Culver City Police Department jurisdiction and qualifies to be reported to the state as a justifiable homicide, the Operations Bureau Commander will ensure that the Records Supervisor is provided with enough information to meet the reporting requirements (Penal Code § 196; Penal Code § 13022).

Firearms

307.1 PURPOSE AND SCOPE

This policy provides guidelines for issuing firearms, the safe and legal carrying of firearms, firearms maintenance and firearms training.

This policy does not apply to issues related to the use of firearms that are addressed in the Use of Force or Officer-Involved Shootings and Deaths policies.

This policy only applies to those members who are authorized to carry firearms.

307.2 POLICY

The Culver City Police Department will equip its members with firearms to address the risks posed to the public and Department members by violent and sometimes well-armed persons. The Department will ensure firearms are appropriate and in good working order and that relevant training is provided as resources allow.

307.3 AUTHORIZED FIREARMS, AMMUNITION AND OTHER WEAPONS

Members shall only use firearms that are issued or approved by the Department and have been thoroughly inspected by the Rangemaster. Except in an emergency or as directed by a supervisor, no firearm shall be carried by a member who has not qualified with that firearm at an authorized department range.

All other weapons not provided by the Department, including but not limited to edged weapons, chemical or electronic weapons, impact weapons or any weapon prohibited or restricted by law or that is not covered elsewhere by department policy, may not be carried by members in the performance of their official duties without the express written authorization of the member's Bureau Commander. This exclusion does not apply to the carrying of a single folding pocketknife that is not otherwise prohibited by law.

307.3.1 HANDGUNS

The authorized department-issued handgun is the Glock 9mm or .45 cal or any modern high-quality firearm approved by the Chief of Police or his/her designee. The caliber of the duty handgun shall be of a 9mm,.40 Smith and Wesson, or.45 ACP variety

307.3.2 SHOTGUNS

The authorized department-issued shotgun is the Benelli 12-gauge semi-automatic shotgun.

When not deployed, the shotgun shall be properly secured consistent with department training in a locking weapons rack in the patrol vehicle.

307.3.3 PATROL RIFLES

The authorized department-issued patrol rifle is the LWRCI M6 carbine or the Colt M4 Commando 5.56 mm semi-automatic rifle.

Culver City Police Department

Culver City PD Policy Manual

Firearms

Members may deploy the patrol rifle in any circumstance where the member can articulate a reasonable expectation that the rifle may be needed. Examples of some general guidelines for deploying the patrol rifle may include but are not limited to:

- (a) Situations where the member reasonably anticipates an armed encounter.
- (b) When a member is faced with a situation that may require accurate and effective fire at long range.
- (c) Situations where a member reasonably expects the need to meet or exceed a suspect's firepower.
- (d) When a member reasonably believes that there may be a need to fire on a barricaded person or a person with a hostage.
- (e) When a member reasonably believes that a suspect may be wearing body armor.
- (f) When authorized or requested by a supervisor.
- (g) When needed to euthanize an animal.

When not deployed, the patrol rifle shall be properly secured consistent with department training in a locking weapons rack in the patrol vehicle.

307.3.4 SUBMACHINE GUNS

The authorized department-issued submachine gun is the Heckler & Koch MP-5, 9mm.

When not deployed, the submachine gun shall be properly secured in a locking weapons rack in the patrol vehicle or secured in the rear cargo area of the patrol vehicle in a rifle case.

The MP-5 will be in "Patrol Ready" condition, with the chamber empty, magazine loaded with 28 rounds and inserted into the magazine well, the bolt forward with the selector lever in the "SAFE" position.

Members may deploy the rifle in any circumstance where the member can articulate a reasonable expectation that the rifle may be needed. Examples of some general guidelines for deploying the rifle may include, but are not limited to:

- (a) Situations where the member reasonably anticipates an armed encounter.
- (b) When a member is faced with a situation that may require accurate and effective fire beyond handgun qualification range.
- (c) Situations where a member reasonably expects the need to meet or exceed a suspect's firepower.
- (d) When a member reasonably believes that there may be a need to fire on a barricaded person or a person with a hostage.
- (e) When a member reasonably believes that a suspect may be wearing body armor.
- (f) When authorized or requested by a supervisor.
- (g) When needed to euthanize an animal.

Culver City Police Department

Culver City PD Policy Manual

Firearms

307.3.5 PERSONALLY OWNED DUTY FIREARMS

Members desiring to carry an authorized but personally owned duty firearm must receive written approval from the Chief of Police or the authorized designee. Once approved, personally owned duty firearms are subject to the following restrictions:

- (a) The firearm shall be in good working order and approved by the Chief of Police or his designee.
- (b) The firearm shall be inspected by the Rangemaster prior to being carried and thereafter shall be subject to inspection whenever it is deemed necessary.
- (c) Prior to carrying the firearm, members shall qualify under range supervision and thereafter shall qualify in accordance with the department qualification schedule. Members must demonstrate proficiency and safe handling, and that the firearm functions properly.
- (d) Members shall provide written notice of the make, model, serial number and caliber of the firearm to the Rangemaster, who will maintain a list of the information.

307.3.6 AUTHORIZED SECONDARY HANDGUN

Members desiring to carry an authorized but personally owned secondary handgun must receive written approval from the Chief of Police or the authorized designee. Once approved, personally owned secondary handguns are subject to the following restrictions:

- (a) The caliber of the handgun shall be .380 ACP or larger
- (b) The handgun shall be in good working order and approved by the Chief of Police.
- (c) The purchase of the handgun, holster and ammunition shall be the responsibility of the member.
- (d) The handgun should be carried concealed at all times in such a manner as to prevent unintentional cocking, negligent discharge or loss of physical control and in a holster that completely covers the trigger guard.
- (e) The handgun shall be inspected by the Rangemaster prior to being carried and thereafter shall be subject to inspection whenever it is deemed necessary.
- (f) Ammunition shall be the same as department issue. If the caliber of the handgun is other than department issue, the Chief of Police or the authorized designee shall approve the ammunition.
- (g) Prior to carrying the secondary handgun, members shall qualify under range supervision and thereafter shall qualify in accordance with the department qualification schedule. Members must demonstrate proficiency and safe handling, and that the handgun functions properly.
- (h) Members shall provide written notice of the make, model, serial number and caliber of a secondary handgun to the Rangemaster, who will maintain a list of the information.

307.3.7 AUTHORIZED OFF-DUTY FIREARMS

The carrying of firearms by members while off-duty is permitted by the Chief of Police but may be rescinded should circumstances dictate (e.g., administrative leave). Members who choose to

Culver City Police Department

Culver City PD Policy Manual

Firearms

carry a firearm while off-duty, based on their authority as peace officers, will be required to meet the following guidelines:

- (a) The member may use his/her duty firearm or may use a personally owned firearm that is carried and inspected in accordance with the Personally Owned Duty Firearms requirements in this policy. A member carrying his/her duty firearm will be deemed to have complied with (c), (d) and (e) of this section.
 - 1. The purchase of the personally owned firearm and ammunition shall be the responsibility of the member.
- (b) The firearm shall be carried concealed at all times and in such a manner as to prevent accidental unintentional cocking, discharge or loss of physical control.
- (c) It will be the responsibility of the member to submit the firearm to the Rangemaster for inspection prior to being personally carried. Thereafter the firearm shall be subject to periodic inspection by the Rangemaster.
- (d) Prior to carrying any off-duty firearm, the member shall demonstrate to the Rangemaster that he/she is proficient in handling and firing the firearm and that it will be carried in a safe manner.
- (e) The member will successfully qualify with the firearm prior to it being carried.
- (f) Members shall provide written notice of the make, model, color, serial number and caliber of the firearm to the Rangemaster, who will maintain a list of the information.
- (g) If a member desires to use more than one firearm while off-duty, he/she may do so, as long as all requirements set forth in this policy for each firearm are met.
- (h) Members shall only carry department-authorized ammunition.
- (i) When armed, officers shall carry their badges and Culver City Police Department identification cards under circumstances requiring possession of such identification.

307.3.8 AMMUNITION

Members shall carry only department-authorized ammunition. Members shall be issued fresh ammunition in the specified quantity for all department-issued firearms during the member's firearms qualification. Replacements for unserviceable or depleted ammunition issued by the Department shall be dispensed by the Rangemaster when needed, in accordance with established policy.

Members carrying personally owned authorized firearms of a caliber differing from department-issued firearms shall be responsible for obtaining fresh duty ammunition in accordance with the above, at their own expense.

307.4 EQUIPMENT

Firearms carried on- or off-duty shall be maintained in a clean, serviceable condition. Maintenance and repair of authorized personally owned firearms are the responsibility of the individual member.

Culver City Police Department

Culver City PD Policy Manual

Firearms

307.4.1 REPAIRS OR MODIFICATIONS

Each member shall be responsible for promptly reporting any damage or malfunction of an assigned firearm to a supervisor or the Rangemaster.

Firearms that are the property of the Department may be repaired or modified only by the Rangemaster.

Any repairs or modifications to the member's personally owned firearm shall be done at his/her expense and must be approved by the Rangemaster.

307.4.2 HOLSTERS

Only department/Rangemaster-approved holsters shall be used and worn by members. Members shall periodically inspect their holsters to make sure they are serviceable and provide the proper security and retention of the handgun.

307.4.3 TACTICAL LIGHTS

Tactical lights may only be installed on a firearm carried on-duty after they have been approved in writing by the Chief of Police, via the chain of command and examined and approved by the Rangemaster. Once the approved tactical lights have been properly installed on any firearm, the member shall qualify with the firearm to ensure proper functionality and sighting of the firearm prior to carrying it

307.5 SAFE HANDLING, INSPECTION AND STORAGE

Members shall maintain the highest level of safety when handling firearms and shall consider the following:

- (a) Members shall not unnecessarily display or handle any firearm.
- (b) Members shall be governed by all rules and regulations pertaining to the use of the range and shall obey all orders issued by the Rangemaster. Members shall not dry fire or practice quick draws except as instructed by the Rangemaster or other firearms training staff.
- (c) Members shall not clean, repair, load or unload a firearm anywhere in the Department, except where clearing barrels are present.
- (d) Shotguns or rifles removed from vehicles or the equipment storage room shall be loaded and unloaded in the parking lot and outside of the vehicle, using clearing barrels.
- (e) Members shall not place or store any firearm or other weapon on department premises except where the place of storage is locked. No one shall carry firearms into the jail section or any part thereof when securing or processing an arrestee, but shall place all firearms in a secured location. Members providing access to the jail section to persons from outside agencies are responsible for ensuring firearms are not brought into the jail section.
- (f) Members shall not use any automatic firearm, heavy caliber rifle, gas or other type of chemical weapon or firearm from the armory, except with approval of a supervisor.

Culver City Police Department

Culver City PD Policy Manual

Firearms

- (g) Any firearm authorized by the Department to be carried on- or off-duty that is determined by a member to be malfunctioning or in need of service or repair shall not be carried. It shall be promptly presented to the Department or a Rangemaster approved by the Department for inspection and repair. Any firearm deemed in need of repair or service by the Rangemaster will be immediately removed from service. If the firearm is the member's primary duty firearm, a replacement firearm will be issued to the member until the duty firearm is serviceable.

307.5.1 INSPECTION AND STORAGE

Handguns shall be inspected regularly and upon access or possession by another person. Shotguns and rifles shall be inspected at the beginning of the shift by the member to whom the weapon is issued. The member shall ensure that the firearm is carried in the proper condition and loaded with approved ammunition. Inspection of the shotgun and rifle shall be done while standing outside of the patrol vehicle. All firearms shall be pointed in a safe direction or into clearing barrels.

Personally owned firearms may be safely stored in lockers at the end of the shift. Department-owned firearms shall be stored in the appropriate equipment storage room. Handguns may remain loaded if they are secured in an appropriate holster. Shotguns and rifles shall be unloaded in a safe manner outside the building and then stored in the appropriate equipment storage room.

307.5.2 STORAGE AT HOME

Members shall ensure that all firearms and ammunition are locked and secured while in their homes, vehicles or any other area under their control, and in a manner that will keep them inaccessible to children and others who should not have access. Members shall not permit department-issued firearms to be handled by anyone not authorized by the Department to do so. Members should be aware that negligent storage of a firearm could result in civil and criminal liability (Penal Code § 25100).

307.5.3 ALCOHOL AND DRUGS

Firearms shall not be carried by any member, either on- or off-duty, who has consumed an amount of an alcoholic beverage, taken any drugs or medication, or has taken any combination thereof that would tend to adversely affect the member's senses or judgment.

307.5.4 STORAGE IN VEHICLES

When leaving a handgun in an unattended vehicle, members shall ensure that it is locked in the trunk, or in a locked container that is placed out of view, or in a locked container that is permanently affixed to the vehicle's interior and not in plain view, or in a locked toolbox or utility box permanently affixed to the vehicle (Penal Code § 16850; Penal Code § 25140; Penal Code § 25452).

If the vehicle does not have a trunk or a locked container, then the firearm should be locked within the center utility console that can be locked with a padlock, keylock, combination lock, or other similar locking device (Penal Code § 25140).

Officers are exempt from these requirements during circumstances requiring immediate aid or action in the course of official duties (Penal Code § 25140).

Culver City Police Department

Culver City PD Policy Manual

Firearms

307.6 FIREARMS TRAINING AND QUALIFICATIONS

All members who carry a firearm while on-duty are required to successfully complete training with their duty firearms. In addition to training, all members will qualify bi-annually with their duty firearms and secondary firearms at least twice a year. Training and qualifications must be on an approved range course.

At least annually, all members carrying a firearm should receive practical training designed to simulate field situations including low-light shooting.

307.6.1 NON-CERTIFICATION OR NON-QUALIFICATION

If any member fails to meet minimum standards for firearms training or qualification for any reason, including injury, illness, duty status or scheduling conflict, that member shall submit a memorandum to his/her immediate supervisor prior to the end of the required training or qualification period.

Those who fail to meet minimum standards or qualify on their first shooting attempt shall be provided remedial training and will be subject to the following requirements:

- (a) Additional range assignments may be scheduled to assist the member in demonstrating consistent firearm proficiency.
- (b) Members shall be given credit for a range training or qualification when obtaining a qualifying score or meeting standards after remedial training.
- (c) No range credit will be given for the following:
 - 1. Unauthorized range make-up
 - 2. Failure to meet minimum standards or qualify after remedial training

Members who repeatedly fail to meet minimum standards will be removed from field assignment and may be subject to disciplinary action.

307.7 FIREARM DISCHARGE

Except during training or sporting use, any member who discharges a firearm intentionally or unintentionally, on- or off-duty, shall make a verbal report to his/her supervisor as soon as circumstances permit. If the discharge results in injury or death to another person, additional statements and reports shall be made in accordance with the Officer-Involved Shootings and Deaths Policy. If a firearm was discharged as a use of force, the involved member shall adhere to the additional reporting requirements set forth in the Use of Force Policy.

In all other cases, written reports shall be made as follows:

- (a) If on-duty at the time of the incident, the member shall file a written report with his/her Bureau Commander or provide a recorded statement to investigators prior to the end of shift, unless otherwise directed.
- (b) If off-duty at the time of the incident, a written report shall be submitted or recorded statement provided no later than the end of the next regularly scheduled shift, unless otherwise directed by a supervisor.

Culver City Police Department

Culver City PD Policy Manual

Firearms

307.7.1 DESTRUCTION OF ANIMALS

Members are authorized to use firearms to stop an animal in circumstances where the animal reasonably appears to pose an imminent threat to human safety and alternative methods are not reasonably available or would likely be ineffective.

In circumstances where there is sufficient advance notice that a potentially dangerous animal may be encountered, department members should develop reasonable contingency plans for dealing with the animal (e.g., fire extinguisher, conducted energy device, oleoresin capsicum (OC) spray, animal control officer). Nothing in this policy shall prohibit any member from shooting a dangerous animal if circumstances reasonably dictate that a contingency plan has failed, becomes impractical, or if the animal reasonably appears to pose an imminent threat to human safety.

307.7.2 INJURED ANIMALS

With the approval of a supervisor, a member may euthanize an animal that is so badly injured that human compassion requires its removal from further suffering and where other dispositions are impractical.

Stray or abandoned injured animals that may be moved or taken to an available veterinarian should not be euthanized. With supervisor approval, abandoned injured animals (with the exception of dogs and cats) may only be euthanized after a reasonable search to locate the owner has been made. Injured dogs and cats found without their owners shall be taken to an appropriate veterinarian for determination of whether they should be treated or humanely destroyed (Penal Code § 597.1).

307.7.3 WARNING AND OTHER SHOTS

Generally, shots fired for the purpose of summoning aid are discouraged and may not be discharged unless the member reasonably believes that they appear necessary, effective, and reasonably safe.

Warning shots should not be used.

307.8 RANGEMASTER DUTIES

The range will be under the exclusive control of the Rangemaster. All members attending will follow the directions of the Rangemaster. The Rangemaster will maintain a roster of all members attending the range and will submit the roster to the Personnel and Training Lieutenant after each range date.

The range shall remain operational and accessible to Department members during hours established by the Department.

The Rangemaster has the responsibility of making periodic inspection, at least once a year, of all duty firearms carried by members of this department to verify proper operation. The Rangemaster has the authority to deem any department-issued or personally owned firearm unfit for service. The member will be responsible for all repairs to his/her personally owned firearm and it will not be returned to service until inspected by the Rangemaster.

Culver City Police Department

Culver City PD Policy Manual

Firearms

The Rangemaster has the responsibility for ensuring each member meets the minimum requirements during qualification shoots and, on at least a yearly basis, can demonstrate proficiency in the care, cleaning and safety of all firearms the member is authorized to carry.

The Rangemaster shall complete and submit to the Personnel and Training Lieutenant documentation of the training courses provided. Documentation shall include a description of the training provided and, on a form that has been approved by the Department, a list of each member who completes the training. The Rangemaster should keep accurate records of all training shoots, qualifications, or other records as directed by the Personnel and Training Lieutenant.

307.9 FLYING WHILE ARMED

The Transportation Security Administration (TSA) has imposed rules governing law enforcement officers flying armed on commercial aircraft. The following requirements apply to officers who intend to be armed while flying on a commercial air carrier or flights where screening is conducted (49 CFR 1544.219):

- (a) Officers wishing to fly while armed must be flying in an official capacity, not for vacation or pleasure, and must have a need to have the firearm accessible, as determined by the Department based on the law and published TSA rules.
- (b) Officers must carry their Culver City Police Department identification card, bearing the officer's name, a full-face photograph, identification number, the officer's signature and the signature of the Chief of Police or the official seal of the Department and must present this identification to airline officials when requested. The officer should also carry the standard photo identification needed for passenger screening by airline and TSA officials (e.g., driver license, passport).
- (c) The Culver City Police Department must submit a National Law Enforcement Telecommunications System (NLETS) message prior to the officer's travel. If approved, TSA will send the Culver City Police Department an NLETS message containing a unique alphanumeric identifier. The officer must present the message on the day of travel to airport personnel as authorization to travel while armed.
- (d) An official letter signed by the Chief of Police authorizing armed travel may also accompany the officer. The letter should outline the officer's need to fly armed, detail his/her itinerary, and include that the officer has completed the mandatory TSA training for a law enforcement officer flying while armed.
- (e) Officers must have completed the mandated TSA security training covering officers flying while armed. The training shall be given by the department-appointed instructor.
- (f) It is the officer's responsibility to notify the air carrier in advance of the intended armed travel. This notification should be accomplished by early check-in at the carrier's check-in counter.
- (g) Any officer flying while armed should discreetly contact the flight crew prior to take-off and notify them of his/her assigned seat.
- (h) Discretion must be used to avoid alarming passengers or crew by displaying a firearm. The officer must keep the firearm concealed on his/her person at all times.

Culver City Police Department

Culver City PD Policy Manual

Firearms

Firearms are not permitted in carry-on luggage and may not be stored in an overhead compartment.

- (i) Officers should try to resolve any problems associated with flying armed through the flight captain, ground security manager, TSA representative or other management representative of the air carrier.
- (j) Officers shall not consume alcoholic beverages while aboard an aircraft, or within eight hours prior to boarding an aircraft.

307.10 CARRYING FIREARMS OUT OF STATE

Qualified, active, full-time officers of this department are authorized to carry a concealed firearm in all other states subject to the following conditions (18 USC § 926B):

- (a) The officer shall carry his/her Culver City Police Department identification card whenever carrying such firearm.
- (b) The officer is not the subject of any current disciplinary action.
- (c) The officer may not be under the influence of alcohol or any other intoxicating or hallucinatory drug.
- (d) The officer will remain subject to this and all other department policies (including qualifying and training).

Officers are cautioned that individual states may enact local regulations that permit private persons or entities to prohibit or restrict the possession of concealed firearms on their property, or that prohibit or restrict the possession of firearms on any state or local government property, installation, building, base or park. Federal authority may not shield an officer from arrest and prosecution in such locally restricted areas.

Active law enforcement officers from other states are subject to all requirements set forth in 18 USC § 926B.

Department Firing Range

308.1 PURPOSE AND SCOPE

This policy outlines the parameters of the firing range regarding its use, safety rules, hours of operation and permitted users. The Culver City Police Department firing range is for the personnel of this agency, to advance firearm proficiency and maintain existing skills. It is the intent of this agency to establish a policy that allows for convenient around the clock access and accountability in its use and maintenance.

308.2 RANGE USE

- (a) The range may not be used alone, personnel must have a "Range Partner"
- (b) Personnel must obtain Watch Commander's approval, prior to using the range
- (c) The key for the range door can be obtained from the Watch Commander or Personnel and Training
- (d) A liability waiver must be signed with the Watch Commander prior to range use (non-employee only)
- (e) No eating, drinking, smoking, or chewing tobacco in the range or adjacent offices
- (f) Only non-toxic, lead free ammunition may be used by persons using the range
- (g) Leaded ammunition may be used for some department sanctioned shoots
- (h) The trap will accommodate projectiles from a .22 handgun to high powered rifles
- (i) Pellet and BB guns are not permitted
- (j) Only 00 buckshot and slugs may be fired through shotguns (NO BIRDSHOT)
- (k) Be sure your firearms are safe and operational
- (l) Turn on the ventilation fan upon entry to range
- (m) All range users are personally responsible for safety on the range
- (n) Do not place target stands between the red line and the trap
- (o) Firing is only allowed downrange of the green line
- (p) All City brass is property of the City and will be sold to offset operating costs
- (q) Personnel are accountable to clean range floor and cleaning room after each use
- (r) Place target stands and target frames back in an orderly manner
- (s) To reduce airborne debris, use HEPA vacuum to clean the floor
- (t) Report any damage to the Watch Commander immediately

Culver City Police Department

Culver City PD Policy Manual

Department Firing Range

- (u) When done on the range, the inspecting Watch Commander or designee will "sign off" the Range Log
- (v) Any damages to any portion of the range will be documented on an Officer's Report and forwarded to the Assistant Chief of Police.
- (w) When done, shut down the ventilation fan, turn off all range lights, close and lock the hallway range door

308.2.1 SAFETY RULES

- (a) Treat every firearm as if it were loaded
- (b) Always keep the muzzle pointed in a safe direction
- (c) Keep your finger outside the trigger guard until you are ready to fire
- (d) Be sure of your target and what is beyond it
- (e) Always wear proper eye and ear protection
- (f) Before and during firing, know where others are at all times
- (g) Only use paper targets and supplied target stands
- (h) Never attempt to catch a falling or dropped firearm
- (i) Never handle live weapons or shoot on the range alone
- (j) Before walking down range announce your intent

308.2.2 HOURS OF OPERATION

The firing range will be open around the clock to allow all shifts convenient access to train and practice in firearms. Some "Black-Out" times may occur during station meetings or in-house training, where the reverberation of gunfire may be a distraction.

308.2.3 PERMITTED USERS

All members of the Police Department, who are in good standing, are allowed to utilize the firing range with the approval of the Watch Commander or his/her designee. Guests of Police Department employees may be permitted to utilize the firing range with the approval of the Watch Commander and accompanied by a member of this Department. Non Sworn employees must, prior to using the range, demonstrate to a sworn member of the department a working knowledge of the firearm(s) they are going to use, and show they are proficient in the use of said firearm(s). Minor guests shall be supervised at all times by qualified Police Department personnel. Outside police agencies may use the firing range with the approval of the Chief of Police or his designee. All guests shall sign a City liability waiver with the Watch Commander.

The Range Liability Waiver can be found in the Department network in the "CCPD Resources" folder.

Vehicle Pursuits

309.1 PURPOSE AND SCOPE

This policy provides guidelines for vehicle pursuits in order to protect the safety of involved officers, the public, and fleeing suspects.

309.1.1 DEFINITIONS

Blocking - A low-speed tactic where one or more authorized police department emergency vehicles intentionally restrict the movement of a suspect vehicle, with the goal of containment or preventing a pursuit. Blocking is not boxing in or a roadblock.

Boxing-in - A tactic designed to stop a suspect's moving vehicle by surrounding it with law enforcement vehicles and then slowing all vehicles to a stop.

Pursuit Intervention - An attempt to stop the suspect's ability to continue to flee in a vehicle through tactical application of technology, tire deflation devices, blocking or vehicle intercept, boxing-in, the PIT (known as Pursuit Intervention Technique or Precision Immobilization Technique), ramming, or roadblock procedures.

Pursuit Intervention Technique (PIT) - A low-speed tactic intentionally applied to cause the suspect vehicle to spin out and terminate the pursuit.

Ramming - The deliberate act of impacting a suspect's vehicle with another vehicle to functionally damage or otherwise force the suspect's vehicle to stop.

Roadblocks - A tactic designed to stop a suspect's vehicle by intentionally placing an emergency vehicle or other immovable object in the path of the suspect's vehicle.

Tire deflation device - A device that extends across the roadway designed to puncture the tires of the pursued vehicle, sometimes referred to as spike strips.

Terminate - To discontinue a pursuit or stop chasing fleeing vehicles.

Trail - Following the path of the pursuit at a safe speed while obeying all traffic laws and without activating emergency equipment. If the pursuit is at a slow rate of speed, the trailing vehicle will maintain sufficient distance from the pursuit vehicles so as to clearly indicate an absence of participation in the pursuit

Vehicle Pursuit - An event involving one or more law enforcement officers attempting to apprehend a suspect, who is attempting to avoid arrest while operating a motor vehicle by using high-speed driving or other evasive tactics, such as driving off a highway, turning suddenly, or driving in a legal manner but willfully failing to yield to an officer's signal to stop.

309.2 OFFICER RESPONSIBILITIES

Vehicle pursuits shall only be conducted using authorized police department emergency vehicles that are equipped with and displaying emergency lighting and sirens as required by Vehicle Code

Culver City Police Department

Culver City PD Policy Manual

Vehicle Pursuits

§ 21055. Officers are responsible for continuously driving with due regard and caution for the safety of all persons and property (Vehicle Code § 21056).

309.2.1 WHEN TO INITIATE A PURSUIT

Officers are authorized to initiate a pursuit when the officer reasonably believes that a suspect, who has been given appropriate signal to stop by a law enforcement officer, is attempting to evade arrest or detention by fleeing in a vehicle.

Factors that should be considered in deciding whether to initiate a pursuit include:

- (a) The seriousness of the known or reasonably suspected crime and its relationship to community safety.
- (b) The importance of protecting the public and balancing the known or reasonably suspected offense and the apparent need for immediate capture against the risks to officers, innocent motorists, and others.
- (c) The safety of the public in the area of the pursuit, including the type of area, time of day, the amount of vehicular and pedestrian traffic (e.g., school zones), and the speed of the pursuit relative to these factors.
- (d) The pursuing officers' familiarity with the area of the pursuit, the quality of radio communications between the pursuing units and the dispatcher supervisor, and the driving capabilities of the pursuing officers under the conditions of the pursuit.
- (e) Whether weather, traffic, and road conditions unreasonably increase the danger of the pursuit when weighed against the risk of the suspect's escape.
- (f) Whether the identity of the suspect has been verified and whether there is comparatively minimal risk in allowing the suspect to be apprehended at a later time.
- (g) The performance capabilities of the vehicles used in the pursuit in relation to the speeds and other conditions of the pursuit.
- (h) Emergency lighting and siren limitations on unmarked police department vehicles that may reduce visibility of the vehicle, such as visor or dash-mounted lights, concealable or temporary emergency lighting equipment, and concealed or obstructed siren positioning.
- (i) Suspect and officer vehicle speeds.
- (j) Other persons in or on the pursued vehicle (e.g., passengers, co-offenders, hostages).
- (k) Availability of other resources such as air support or vehicle locator or deactivation technology.

309.2.2 WHEN TO TERMINATE A PURSUIT

Pursuits should be terminated whenever the totality of objective circumstances known or which reasonably ought to be known to the officer or supervisor during the pursuit indicates that the present risks of continuing the pursuit reasonably appear to outweigh the risks resulting from the suspect's escape.

Culver City Police Department

Culver City PD Policy Manual

Vehicle Pursuits

The factors listed in this policy on when to initiate a pursuit will apply equally to the decision to terminate a pursuit. Officers and supervisors must objectively and continuously weigh the seriousness of the offense against the potential danger to innocent motorists, themselves, and the public when electing to continue a pursuit.

In addition to the factors that govern when to initiate a pursuit, other factors should be considered in deciding whether to terminate a pursuit, including:

- (a) The distance between the pursuing vehicle and the fleeing vehicle is so great that further pursuit would be futile or require the pursuit to continue for an unreasonable time and/or distance.
- (b) The pursued vehicle's location is no longer definitely known.
- (c) The pursuing vehicle sustains damage or a mechanical failure that renders it unsafe to drive.
- (d) The pursuing vehicle's emergency lighting equipment or siren becomes partially or completely inoperable.
- (e) Hazards to uninvolved bystanders or motorists.
- (f) The danger that the continued pursuit poses to the public, the officers, or the suspect, balanced against the risk of allowing the suspect to remain at large.
- (g) The identity of the suspect is known and it does not reasonably appear that the need for immediate capture outweighs the risks associated with continuing the pursuit.
- (h) Extended pursuits of violators for misdemeanors not involving violence, risk of serious harm, or weapons (independent of the pursuit) are generally discouraged.

309.2.3 SPEED LIMITS

The speed of a pursuit is a factor that should be evaluated on a continuing basis by the officer and supervisor. Evaluation of vehicle speeds should take into consideration public safety, officer safety, and the safety of the occupants of the fleeing vehicle.

Should high vehicle speeds be reached during a pursuit, officers and supervisors should also consider these factors when determining the reasonableness of the speed of the pursuit:

- (a) Pursuit speeds have become unreasonably unsafe for the surrounding conditions.
- (b) Pursuit speeds have exceeded the driving ability of the officer.
- (c) Pursuit speeds are beyond the capabilities of the pursuit vehicle thus making its operation unsafe.

309.3 PURSUIT UNITS

When involved in a pursuit, unmarked police department emergency vehicles should be replaced by marked emergency vehicles whenever practicable

Vehicle pursuits should be limited to three vehicles (two units and a supervisor); however, the number of units involved may vary with the circumstances.

Culver City Police Department

Culver City PD Policy Manual

Vehicle Pursuits

An officer or supervisor may request additional units to join a pursuit if, after assessing the factors outlined above, it reasonably appears that the number of officers involved may be insufficient to safely arrest the suspects. All other officers should stay out of the pursuit, but should remain alert to its progress and location in the event that they are summoned to assist the involved officers.

309.3.1 MOTORCYCLE OFFICERS

When involved in a pursuit, police department motorcycles should be replaced by marked four-wheel emergency vehicles as soon as practicable.

309.3.2 VEHICLES WITHOUT EMERGENCY EQUIPMENT

Officers operating vehicles not equipped with red light and siren are prohibited from initiating or joining in any pursuit.

309.3.3 PRIMARY UNIT RESPONSIBILITIES

The initial pursuing unit will be designated as the primary pursuit unit and will be responsible for the conduct of the pursuit unless the officer is unable to remain reasonably close to the suspect's vehicle. The primary responsibility of the officer initiating the pursuit is the apprehension of the suspects without unreasonable danger to any person.

The primary unit should notify the dispatcher commencing with a request for priority radio traffic, that a vehicle pursuit has been initiated, and as soon as practicable provide information including but not limited to:

- (a) The location, direction of travel, and estimated speed of the suspect's vehicle.
- (b) The description of the suspect's vehicle including license plate number, if known.
- (c) The reason for the pursuit.
- (d) Known or suspected weapons. Threat of force, violence, injuries, hostages, or other unusual hazards.
- (e) The suspected number of occupants and identity or description.
- (f) The weather, road, and traffic conditions.
- (g) The need for any additional resources or equipment.
- (h) The identity of other law enforcement agencies involved in the pursuit.

Until relieved by a supervisor or secondary unit, the officer in the primary unit is responsible for the broadcasting of the progress of the pursuit. Unless circumstances reasonably indicate otherwise, the primary pursuing officer should, as soon as practicable, relinquish the responsibility of broadcasting the progress of the pursuit to a secondary unit or air support joining the pursuit to minimize distractions and allow the primary pursuing officer to concentrate foremost on safe pursuit tactics.

309.3.4 SECONDARY UNIT RESPONSIBILITIES

The second officer in the pursuit will be designated as the secondary unit and is responsible for:

- (a) Immediately notifying the dispatcher of entry into the pursuit.

Culver City Police Department

Culver City PD Policy Manual

Vehicle Pursuits

- (b) Remaining a safe distance behind the primary unit unless directed to assume the role of primary pursuit vehicle or if the primary pursuit vehicle is unable to continue the pursuit.
- (c) Broadcasting the progress, updating known or critical information, and providing changes in the pursuit, unless the situation indicates otherwise.
- (d) Identifying the need for additional resources or equipment as appropriate.
- (e) Serving as backup to the primary pursuing officer once the suspect has been stopped.

309.3.5 PURSUIT DRIVING

The decision to use specific driving tactics requires the same assessment of the factors the officer considered when determining whether to initiate and/or terminate a pursuit. The following are tactics for units involved in the pursuit:

- (a) Officers, considering their driving skills and vehicle performance capabilities, will space themselves from other involved vehicles such that they are able to see and avoid hazards or react safely to maneuvers by the fleeing vehicle.
- (b) Because intersections can present increased risks, the following tactics should be considered:
 - 1. Available units not directly involved in the pursuit may proceed safely to controlled intersections ahead of the pursuit in an effort to warn cross traffic.
 - 2. Pursuing units should exercise due regard and caution when proceeding through controlled intersections.
- (c) As a general rule, officers should not pursue a vehicle driving left of center (wrong way) against traffic. In the event that the pursued vehicle does so, the following tactics should be considered:
 - 1. Requesting assistance from available air support.
 - 2. Maintain visual contact with the pursued vehicle by paralleling it on the correct side of the roadway.
 - 3. Request other units to observe exits available to the suspects.
- (d) Notify the California Highway Patrol (CHP) and/or other law enforcement agency if it appears that the pursuit may enter its jurisdiction.
- (e) Officers involved in a pursuit should not attempt to pass other units unless the situation indicates otherwise or they are requested to do so by the primary unit and with a clear understanding of the maneuver process between the involved units.

309.3.6 PURSUIT TRAILING

In the event the initiating unit from this agency either relinquishes control of the pursuit to another unit or jurisdiction, that initiating unit may, with permission of a supervisor, trail the pursuit to the termination point in order to provide information and assistance for the arrest of the suspects and reporting the incident.

Culver City Police Department

Culver City PD Policy Manual

Vehicle Pursuits

The term trail means to follow the path of the pursuit at a safe speed while obeying all traffic laws and without activating emergency equipment. If the pursuit is at a slow rate of speed, the trailing unit will maintain sufficient distance from the pursuit units so as to clearly indicate an absence of participation in the pursuit.

309.3.7 AIR SUPPORT ASSISTANCE

When available, air support assistance should be requested. Once the air unit has established visual contact with the pursued vehicle, the unit should assume control over the pursuit. The primary and secondary ground units, or involved supervisor, will maintain operational control but should consider whether the participation of air support warrants the continued close proximity and/or involvement of ground units in the pursuit.

The air unit should coordinate the activities of resources on the ground, report progress of the pursuit and provide officers and supervisors with details of upcoming traffic congestion, road hazards, or other pertinent information to evaluate whether to continue the pursuit. If ground units are not within visual contact of the pursued vehicle and the air support unit determines that it is unsafe to continue the pursuit, the air support unit should recommend terminating the pursuit.

309.3.8 UNITS NOT INVOLVED IN THE PURSUIT

There should be no paralleling of the pursuit route. Officers are authorized to use emergency equipment at intersections along the pursuit path to clear intersections of vehicular and pedestrian traffic to protect the public. Officers should remain in their assigned area and should not become involved with the pursuit unless directed otherwise by a supervisor.

The primary and secondary units should be the only units operating under emergency conditions (red light and siren) unless other units are assigned to the pursuit.

309.4 SUPERVISORY CONTROL AND RESPONSIBILITIES

Available supervisory and management control will be exercised over all vehicle pursuits involving officers from this department.

The field supervisor of the officer initiating the pursuit, or if unavailable, the nearest field supervisor will be responsible for:

- (a) Immediately notifying involved unit and the dispatcher of supervisory presence and ascertaining all reasonably available information to continuously assess the situation and risk factors associated with the pursuit.
- (b) Engaging in the pursuit, when appropriate, to provide on-scene supervision.
- (c) Exercising management and control of the pursuit even if not engaged in it.
- (d) Ensuring that no more than the required number of units are involved in the pursuit under the guidelines set forth in this policy.
- (e) Directing that the pursuit be terminated if, in the supervisor's judgment, it is unreasonable to continue the pursuit under the guidelines of this policy.

Culver City Police Department

Culver City PD Policy Manual

Vehicle Pursuits

- (f) Ensuring that assistance from air support, canines, or additional resources is requested, if available and appropriate.
- (g) Ensuring that the proper radio channel is being used.
- (h) Ensuring that the Watch Commander is notified of the pursuit as soon as practicable.
- (i) Ensuring the notification and/or coordination of outside agencies if the pursuit either leaves or is likely to leave the jurisdiction of this department.
- (j) Controlling and managing Culver City Police Department units when a pursuit enters another jurisdiction.
- (k) Preparing a post-pursuit review and documentation of the pursuit.
 - 1. Supervisors should initiate follow up or additional review when appropriate.

309.4.1 WATCH COMMANDER RESPONSIBILITIES

Upon becoming aware that a pursuit has been initiated, the Watch Commander should monitor and continually assess the situation and ensure the pursuit is conducted within the guidelines and requirements of this policy. Once notified, the Watch Commander has the final responsibility for the coordination, control, and termination of a vehicle pursuit and shall be in overall command.

The Watch Commander shall review all pertinent reports for content and forward to the Bureau Commander.

309.5 SOUTHBAY RCC

If the pursuit is confined within the City limits, radio communications will be conducted on the primary channel unless instructed otherwise by a supervisor or dispatcher. If the pursuit leaves the jurisdiction of this department or such is imminent, involved units should, whenever available, switch radio communications to a tactical or emergency channel most accessible by participating agencies and units.

309.5.1 SOUTHBAY RCC RESPONSIBILITIES

Upon notification or becoming aware that a pursuit has been initiated, the dispatcher is responsible for:

- (a) Clearing the radio channel of non-emergency traffic.
- (b) Coordinating pursuit communications of the involved units and personnel.
- (c) Broadcasting pursuit updates as well as other pertinent information as necessary.
- (d) Ensuring that a field supervisor is notified of the pursuit.
- (e) Notifying and coordinating with other involved or affected agencies as practicable.
- (f) Notify the Watch Commander as soon as practicable.
- (g) Assigning an incident number and logging all pursuit activities.

Culver City Police Department

Culver City PD Policy Manual

Vehicle Pursuits

309.5.2 LOSS OF PURSUED VEHICLE

When the pursued vehicle is lost, the primary unit should broadcast pertinent information to assist other units in locating suspects. The primary unit or supervisor will be responsible for coordinating any further search for either the pursued vehicle or suspects fleeing on foot.

309.6 INTER-JURISDICTIONAL CONSIDERATIONS

When a pursuit enters another agency's jurisdiction, the primary officer or supervisor, taking into consideration distance traveled, unfamiliarity with the area and other pertinent facts, should determine whether to request the other agency to assume the pursuit. Unless entry into another jurisdiction is expected to be brief, it is generally recommended that the primary officer or supervisor ensure that notification is provided to each outside jurisdiction into which the pursuit is reasonably expected to enter, regardless of whether such jurisdiction is expected to assist.

309.6.1 ASSUMPTION OF PURSUIT BY ANOTHER AGENCY

Officers will relinquish control of the pursuit when another agency has assumed the pursuit, unless the continued assistance of the Culver City Police Department is requested by the agency assuming the pursuit. Upon relinquishing control of the pursuit, the involved officers may proceed, with supervisory approval, to the termination point of the pursuit to assist in the investigation. The supervisor should coordinate such assistance with the assuming agency and obtain any information that is necessary for any reports. Notification of a pursuit in progress should not be construed as a request to join the pursuit. Requests to or from another agency to assume a pursuit should be specific.

309.6.2 PURSUITS EXTENDING INTO THIS JURISDICTION

The agency that initiates a pursuit is responsible for conducting the pursuit. Units from this department should not join a pursuit unless specifically requested to do so by the pursuing agency and with approval from a supervisor. The exception to this is when a single unit from the initiating agency is in pursuit. Under this circumstance, a supervisor may authorize units from this department to join the pursuit until sufficient units from the initiating agency join the pursuit or until additional information is provided allowing withdrawal of the pursuit.

When a request is made for this department to assist or take over a pursuit that has entered the jurisdiction of Culver City Police Department, the supervisor should consider:

- (a) The public's safety within this jurisdiction.
- (b) The safety of the pursuing officers.
- (c) Whether the circumstances are serious enough to continue the pursuit.
- (d) Whether there is adequate staffing to continue the pursuit.
- (e) The ability to maintain the pursuit.

As soon as practicable, a supervisor or the Watch Commander should review a request for assistance from another agency. The Watch Commander or supervisor, after considering the above factors, may decline to assist in, or assume the other agency's pursuit.

Culver City Police Department

Culver City PD Policy Manual

Vehicle Pursuits

Assistance to a pursuing allied agency by officers of this department will terminate at the City limits provided that the pursuing officers have sufficient assistance from other sources. Ongoing participation from this department may continue only until sufficient assistance is present.

In the event that a pursuit from another agency terminates within this jurisdiction, officers should provide appropriate assistance to officers from the allied agency including but not limited to scene control, coordination and completion of supplemental reports, and any other reasonable assistance requested or needed.

309.7 WHEN PURSUIT INTERVENTION IS AUTHORIZED

Whenever practicable, an officer shall seek approval from a supervisor before employing any intervention to stop the pursued vehicle. In deciding whether to use intervention tactics, officers/supervisors should balance the risks of allowing the pursuit to continue with the potential hazards to the public arising from the use of each tactic, the officers, and persons in or on the pursued vehicle to determine which, if any, intervention tactic may be reasonable.

309.7.1 USE OF FIREARMS

An officer should only discharge a firearm at a moving vehicle or its occupants when the officer reasonably believes there are no other reasonable means available to avert the threat of the vehicle, or if deadly force other than the vehicle is directed at the officer or others.

Officers should not shoot at any part of a vehicle in an attempt to disable the vehicle (see the Use of Force Policy).

309.7.2 INTERVENTION STANDARDS

Any intervention tactic, depending upon the conditions and circumstances under which it is used, may present dangers to the officers, the public, or anyone in or on the vehicle being pursued. Certain applications of intervention tactics may be construed to be a use of force, including deadly force, and subject to the policies guiding such use. Officers should consider these facts and requirements prior to deciding how, when, where, and if an intervention tactic should be employed.

- (a) Blocking should only be used after giving consideration to the following:
 - 1. The technique should only be used by officers who have received training in the technique.
 - 2. The need to immediately stop the suspect vehicle or prevent it from leaving reasonably appears to outweigh the risks of injury or death to occupants of the suspect vehicle, officers, or other members of the public.
 - 3. It reasonably appears the technique will contain or prevent the pursuit.
- (b) The PIT should only be used after giving consideration to the following:
 - 1. The technique should only be used by officers who have received training in the technique, including speed restrictions.
 - 2. Supervisory approval should be obtained before using the technique.

Culver City Police Department

Culver City PD Policy Manual

Vehicle Pursuits

3. The need to immediately stop the suspect vehicle reasonably appears to outweigh the risks of injury or death to occupants of the suspect vehicle, officers, or other members of the public.
 4. It reasonably appears the technique will terminate or prevent the pursuit.
- (c) Ramming a fleeing vehicle should only be done after giving consideration to the following:
1. Supervisory approval should be obtained before using the technique.
 2. The need to immediately stop the suspect vehicle reasonably appears to substantially outweigh the risks of injury or death to occupants of the suspect vehicle, officers, or other members of the public.
 3. It reasonably appears the technique will terminate or prevent the pursuit.
 4. Ramming may be used only under circumstances when deadly force would be authorized.
 5. Ramming may be used when all other reasonable alternatives have been exhausted or reasonably appear ineffective.
- (d) Before attempting to box a suspect vehicle during a pursuit the following should be considered:
1. The technique should only be used by officers who have received training in the technique.
 2. Supervisory approval should be obtained before using the technique.
 3. The need to immediately stop the suspect vehicle reasonably appears to outweigh the risks of injury or death to occupants of the suspect vehicle, officers, or other members of the public.
 4. It reasonably appears the technique will terminate or prevent the pursuit.
- (e) Tire deflation devices should only be used after considering the following:
1. Tire deflation devices should only be used by officers who have received training in their use.
 2. Supervisory approval should be obtained before using tire deflation devices.
 3. The need to immediately stop the suspect vehicle reasonably appears to outweigh the risks of injury or death to occupants of the suspect vehicle, officers, or other members of the public.
 4. It reasonably appears the use will terminate or prevent the pursuit.
 5. Tire deflation devices should not be used when the pursued vehicle is a motorcycle, a vehicle transporting hazardous materials, or a school bus transporting children, except in extraordinary circumstances.
 6. Due to the increased risk to officers deploying tire deflation devices, such deployment should be communicated to all involved personnel.
- (f) Roadblocks should only be used after considering the following:

Culver City Police Department

Culver City PD Policy Manual

Vehicle Pursuits

1. Roadblocks should only be used by officers who have received training in their use.
2. Supervisory approval should be obtained before using the technique.
3. The need to immediately stop the suspect vehicle reasonably appears to substantially outweigh the risks of injury or death to occupants of the suspect vehicle, officers, or other members of the public.
4. It reasonably appears the technique will terminate or prevent the pursuit. Roadblocks may be used only under circumstances when deadly force would be authorized.
5. Roadblocks may be used when all other reasonable alternatives have been exhausted or reasonably appear ineffective.

309.7.3 CAPTURE OF SUSPECTS

Proper self-discipline and sound professional judgment are the keys to a successful conclusion of a pursuit and apprehension of evading suspects. Officers shall use only that amount of force, which reasonably appears necessary under the circumstances, to accomplish a legitimate law enforcement purpose.

Unless relieved by a supervisor, the primary pursuing officer should coordinate efforts to apprehend the suspects following the pursuit. Officers should consider safety of the public and the involved officers when formulating plans for setting up perimeters or for containing and capturing the suspects.

309.8 REPORTING REQUIREMENTS

All appropriate reports should be completed to comply with applicable laws, policies, and procedures.

- (a) The primary officer should complete appropriate crime/arrest reports.
- (b) The Watch Commander shall ensure that an Allied Agency Vehicle Pursuit Report (form CHP 187A) is filed with the CHP not later than 30 days following the pursuit (Vehicle Code § 14602.1). The primary officer should complete as much of the required information on the form as is known and forward the report to the Watch Commander for review and distribution.
- (c) After first obtaining the available information, the involved, or if unavailable on-duty, field supervisor shall promptly complete a Supervisor's Log or interoffice memorandum, briefly summarizing the pursuit to the Chief of Police or the authorized designee. This log or memorandum should include, at a minimum:
 1. Date and time of pursuit.
 2. Initial reason and circumstances surrounding the pursuit.
 3. Length of pursuit in distance and time, including the starting and termination points.
 4. Involved units and officers.

Culver City Police Department

Culver City PD Policy Manual

Vehicle Pursuits

5. Alleged offenses.
 6. Whether a suspect was apprehended, as well as the means and methods used.
 7. Any use of force that occurred during the vehicle pursuit.
 - (a) Any use of force by a member should be documented in the appropriate report (See the Use of Force Policy).
 8. Any injuries and/or medical treatment.
 9. Any property or equipment damage.
 10. Name of supervisor at scene or who handled the incident.
- (d) After receiving copies of reports, logs, and other pertinent information, the Chief of Police or the authorized designee should conduct or assign the completion of a post-pursuit review.

Annually, the Chief of Police should direct a documented review and analysis of department vehicle pursuit reports to minimally include policy suitability, policy compliance, and training or equipment needs.

309.8.1 REGULAR AND PERIODIC PURSUIT TRAINING

The Personnel and Training Lieutenant shall make available to all officers initial and supplementary Police Officer Standard Training (POST) training on pursuits required by Penal Code § 13519.8, Vehicle Code § 17004.7(d), and 11 CCR 1081, and no less than annual training addressing:

- (a) This policy.
- (b) The importance of vehicle safety and protecting the public.
- (c) The need to balance the known offense and the need for immediate capture against the risks to officers and others.

309.8.2 POLICY REVIEW

Officers of this department shall certify in writing that they have received, read, and understand this policy initially, upon any amendments, and whenever training on this policy is provided. The POST attestation form, or an equivalent form, may be used to document the compliance and should be retained in the member's training file.

309.9 APPLICATION OF VEHICLE PURSUIT POLICY

This policy is expressly written and adopted pursuant to the provisions of Vehicle Code § 17004.7, with additional input from the POST Vehicle Pursuit Guidelines.

309.10 POLICY

It is the policy of this department to balance the importance of apprehending suspects who unlawfully flee from law enforcement against the risks associated with vehicle pursuits.

Officer Response to Calls

310.1 PURPOSE AND SCOPE

This policy provides for the safe and appropriate response to emergency and non-emergency situations whether dispatched or self-initiated.

310.2 RESPONSE TO CALLS

Officers dispatched "Code-3" shall consider the call an emergency response and proceed immediately. Officers responding Code-3 shall continuously operate emergency lighting equipment, including at minimum a steady forward facing red light, and shall sound the siren as reasonably necessary pursuant to Vehicle Code § 21055.

Responding with emergency light(s) and siren does not relieve the officer of the duty to continue to drive with due regard for the safety of all persons. The use of any other warning equipment without a red light and siren does not provide any exemption from the Vehicle Code.

Officers should only respond Code-3 when authorized or when circumstances reasonably indicate an emergency response is required. Officers not authorized to respond Code-3 shall observe all traffic laws and proceed without the use of emergency lights and siren.

310.3 REQUESTING EMERGENCY ASSISTANCE

Requests for emergency assistance should be limited to those situations where the involved personnel reasonably believe that there is an immediate threat to the safety of officers, or assistance is needed to prevent imminent serious harm to a citizen. In any event, where a situation has stabilized and emergency response is not required, the requesting officer shall immediately notify Southbay RCC.

If circumstances permit, the requesting officer should give the following information:

- The unit number
- The location
- The reason for the request and type of emergency
- The number of units required

310.4 INITIATING CODE 3 RESPONSE

If an officer believes a Code-3 response to any call is appropriate, the officer shall notify the Communications Center when reasonably practical. Should another officer believe a code-3 response is appropriate, dispatch shall be notified as soon as practical and the Watch Commander or supervisor will make the determination as to whether one or more officers driving Code-3 is appropriate.

310.5 RESPONSIBILITIES OF RESPONDING OFFICERS

Officers shall exercise sound judgment and care with due regard for life and property when responding to an emergency call. Officers shall reduce speed at all street intersections to such a

Culver City Police Department

Culver City PD Policy Manual

Officer Response to Calls

degree that they shall have complete control of the vehicle and can safely proceed through the intersection.

The decision to continue a Code-3 response is at the discretion of the officer. If, in the officer's judgment, the roadway conditions or traffic congestion does not permit such a response without unreasonable risk, the officer may elect to respond to the call without the use of red lights and siren at the legal speed limit. In such an event, the officer should immediately notify Southbay RCC. An officer shall also discontinue the Code-3 response when directed by a supervisor.

Upon receiving authorization or determining a Code-3 response is appropriate, an officer shall immediately give the location from which he/she is responding.

310.6 COMMUNICATIONS RESPONSIBILITIES

A dispatcher shall assign a Code-3 response when an officer requests emergency assistance or available information reasonably indicates that the public is threatened with serious injury or death and immediate police response is needed. In all other circumstances, the dispatcher shall obtain authorization from the Watch Commander or a field supervisor prior to assigning units Code-3 .

The dispatcher shall:

- (a) Attempt to assign the closest available unit to the location requiring assistance
- (b) Immediately notify the Watch Commander
- (c) Confirm the location from which the unit is responding
- (d) Notify and coordinate allied emergency services (e.g., fire and ambulance)
- (e) Continue to obtain and broadcast information as necessary concerning the response and monitor the situation until it is stabilized or terminated
- (f) Control all radio communications during the emergency and coordinate assistance under the direction of the Watch Commander or field supervisor

310.7 SUPERVISORY RESPONSIBILITIES

Upon being notified that a Code-3 response has been initiated, the Watch Commander or the field supervisor shall verify the following:

- (a) The proper response has been initiated
- (b) No more than those units reasonably necessary under the circumstances are involved in the response
- (c) Affected outside jurisdictions are being notified as practical

The field supervisor shall monitor the response until it has been stabilized or terminated and assert control by directing units into or out of the response if necessary. If, in the supervisor's judgment, the circumstances require additional units to be assigned a Code-3 response, the supervisor may do so.

Culver City Police Department

Culver City PD Policy Manual

Officer Response to Calls

It is the supervisor's responsibility to terminate a Code-3 response that, in his/her judgment is inappropriate due to the circumstances.

When making the decision to authorize a Code-3 response, the Watch Commander or the field supervisor should consider the following:

- The type of call
- The necessity of a timely response
- Traffic and roadway conditions
- The location of the responding units

310.8 FAILURE OF EMERGENCY EQUIPMENT

If the emergency equipment on the vehicle should fail to operate, the officer must terminate the Code-3 response and respond accordingly. In all cases, the officer shall notify the Watch Commander, field supervisor, or Southbay RCC of the equipment failure so that another unit may be assigned to the emergency response.

Canines

311.1 PURPOSE AND SCOPE

This policy establishes guidelines for the use of canines to augment police services in the community, including but not limited to locating individuals and contraband and apprehending criminal offenders.

311.2 POLICY

It is the policy of the Culver City Police Department that handlers and canines meet and maintain the appropriate proficiency to effectively and reasonably carry out legitimate law enforcement objectives.

311.3 ASSIGNMENT

Canine teams should be assigned to assist and supplement the Patrol Bureau to function primarily in assist or cover assignments. However, they may be assigned by the Watch Commander to other functions, such as routine calls for service, based on the current operational needs.

Canine teams should generally not be assigned to handle routine matters that will take them out of service for extended periods of time. If such assignment is necessary, it should only be made with the approval of the Watch Commander.

311.4 CANINE COORDINATOR

The canine coordinator shall be appointed by and directly responsible to the Patrol Bureau or the authorized designee.

The responsibilities of the coordinator include but are not limited to:

- (a) Reviewing all canine use reports to ensure compliance with policy and to identify training issues and other needs of the program.
- (b) Maintaining a liaison with the vendor kennel.
- (c) Maintaining a liaison with command staff and functional supervisors.
- (d) Maintaining a liaison with other agency canine coordinators.
- (e) Maintaining accurate records to document canine activities.
- (f) Recommending and overseeing the procurement of equipment and services for the teams of handlers and canines.
- (g) Scheduling all canine-related activities.
- (h) Ensuring the canine teams are scheduled for regular training to maximize their capabilities.

311.5 REQUESTS FOR CANINE TEAMS

Patrol Bureau members are encouraged to request the use of a canine. Requests for a canine team from department units outside of the Patrol Bureau shall be reviewed by the Watch Commander.

Culver City Police Department

Culver City PD Policy Manual

Canines

311.5.1 OUTSIDE AGENCY REQUEST

All requests for canine assistance from outside agencies must be approved by the Watch Commander or canine coordinator and are subject to the following:

- (a) Canine teams shall not be used for any assignment that is not consistent with this policy.
- (b) It shall be the responsibility of the canine handler to coordinate operations with agency personnel in order to minimize the risk of unintended injury.
- (c) It shall be the responsibility of the canine handler to complete all necessary reports or as directed.

311.5.2 PUBLIC DEMONSTRATION

All public requests for a canine team shall be reviewed and, if appropriate, approved by the canine coordinator prior to making any resource commitment. The canine coordinator is responsible for obtaining resources and coordinating involvement in the demonstration to include proper safety protocols. Canine handlers shall not demonstrate any apprehension work unless authorized to do so by the canine coordinator.

311.6 APPREHENSION GUIDELINES

A canine may be used to locate and apprehend a suspect if the canine handler reasonably believes that the individual has committed, is committing, or is threatening to commit any serious offense and if any of the following conditions exist:

- (a) There is a reasonable belief the suspect poses an imminent threat of violence or serious harm to the public, any officer, or the handler.
- (b) The suspect is physically resisting or threatening to resist arrest and the use of a canine reasonably appears to be necessary to overcome such resistance.
- (c) The suspect is believed to be concealed in an area where entry by other than the canine would pose a threat to the safety of officers or the public.

It is recognized that situations may arise that do not fall within the provisions set forth in this policy. Such events require consideration of the totality of the circumstances and the use of an objective reasonableness standard applied to the decision to use a canine.

Absent a reasonable belief that a suspect has committed, is committing, or is threatening to commit a serious offense, mere flight from a pursuing officer, without any of the above conditions, shall not serve as the basis for the use of a canine to apprehend a suspect.

Use of a canine to locate and apprehend a suspect wanted for a lesser criminal offense than those identified above requires approval from the Watch Commander. Absent a change in circumstances that presents an imminent threat to officers, the canine or the public, such canine use should be conducted on-leash or under conditions that minimize the likelihood the canine will bite or otherwise injure the individual.

Culver City Police Department

Culver City PD Policy Manual

Canines

In all applications, once the suspect has been located and no longer reasonably appears to present a threat or risk of escape, the handler should secure the canine as soon as it becomes reasonably practicable.

If the canine has apprehended the suspect with a secure bite, and the handler believes that the suspect no longer poses a threat, the handler should promptly command the canine to release the suspect.

311.6.1 PREPARATION FOR DEPLOYMENT

Prior to the use of a canine to search for or apprehend any suspect, the canine handler and/or the supervisor on-scene should carefully consider all pertinent information reasonably available at the time. The information should include but is not limited to:

- (a) The nature and seriousness of the suspected offense.
- (b) Whether violence or weapons were used or are anticipated.
- (c) The degree of resistance or threatened resistance, if any, the suspect has shown.
- (d) The suspect's known or perceived age.
- (e) The potential for injury to officers or the public caused by the suspect if the canine is not utilized.
- (f) Any potential danger to the public and/or other officers at the scene if the canine is released.
- (g) The potential for the suspect to escape or flee if the canine is not utilized.

As circumstances permit, the canine handler should make every reasonable effort to communicate and coordinate with other involved members to minimize the risk of unintended injury.

It is the canine handler's responsibility to evaluate each situation and determine whether the use of a canine is appropriate and reasonable. The canine handler shall have the authority to decline the use of the canine whenever he/she deems deployment is unsuitable.

A supervisor who is sufficiently apprised of the situation may prohibit deploying the canine.

Unless otherwise directed by a supervisor, assisting members should take direction from the handler in order to minimize interference with the canine.

311.6.2 WARNINGS AND ANNOUNCEMENTS

Unless it would increase the risk of injury or escape, a clearly audible warning announcing that a canine will be used if the suspect does not surrender should be made prior to releasing a canine. The handler should allow a reasonable time for a suspect to surrender and should quiet the canine momentarily to listen for any verbal response to the warning. If feasible, other members should be in a location opposite the warning to verify that the announcement could be heard. If available, warnings given in other languages should be used as necessary. When feasible, a helicopter should be used to give a canine announcement.

Culver City Police Department

Culver City PD Policy Manual

Canines

If a warning is not to be given, the canine handler, when practicable, should first advise the supervisor of his/her decision before releasing the canine. In the event of an apprehension, the handler shall document in any related report how the warning was given and, if none was given, the reasons why.

311.6.3 REPORTING DEPLOYMENTS, BITES, AND INJURIES

Handlers should document canine deployments in a canine use report. Whenever a canine deployment results in a bite or causes injury to an intended suspect, a supervisor should be promptly notified and the injuries documented in the canine use report. The injured person shall be promptly treated by Emergency Medical Services personnel and, if appropriate, transported to an appropriate medical facility for further treatment. The deployment and injuries should also be included in any related incident or arrest report.

Any unintended bite or injury caused by a canine, whether on- or off-duty, shall be promptly reported to the canine coordinator. Unintended bites or injuries caused by a canine should be documented in an administrative report, not in a canine use report.

If an individual alleges an injury, either visible or not visible, a supervisor shall be notified and both the individual's injured and uninjured areas shall be photographed as soon as practicable after first tending to the immediate needs of the injured party. Photographs shall be retained as evidence in accordance with current department evidence procedures. The photographs shall be retained until the criminal proceeding is completed and the time for any related civil proceeding has expired.

Canines used by law enforcement agencies are generally exempt from impoundment and reporting requirements. However, the canine shall be made available for examination at any reasonable time if requested by the local health department. The canine handler shall also notify the local health department if the canine exhibits any abnormal behavior after a bite (Health and Safety Code § 121685).

311.7 NON-APPREHENSION GUIDELINES

Properly trained canines may be used to track or search for non-criminals (e.g., lost children, individuals who may be disoriented or in need of medical attention). The canine handler is responsible for determining the canine's suitability for such assignments based on the conditions and the particular abilities of the canine. When the canine is deployed in a search or other non-apprehension operation, the following guidelines apply:

- (a) Absent a change in circumstances that presents an imminent threat to officers, the canine, or the public, such applications should be conducted on-leash or under conditions that minimize the likelihood the canine will bite or otherwise injure the individual, if located.
- (b) Unless otherwise directed by a supervisor, assisting members should take direction from the handler in order to minimize interference with the canine.
- (c) Throughout the deployment, the handler should periodically give verbal assurances that the canine will not bite or hurt the individual and encourage the individual to make him/herself known.

Culver City Police Department

Culver City PD Policy Manual

Canines

- (d) Once the individual has been located, the handler should place the canine in a down-stay or otherwise secure it as soon as reasonably practicable.

311.7.1 ARTICLE DETECTION

A canine trained to find objects or property related to a person or crime may be used to locate or identify articles. A canine search should be conducted in a manner that minimizes the likelihood of unintended bites or injuries.

311.7.2 NARCOTICS DETECTION

A canine trained in narcotics detection may be used in accordance with current law and under certain circumstances, including:

- (a) The search of vehicles, buildings, bags, and other articles.
- (b) Assisting in the search for narcotics during a search warrant service.
- (c) Obtaining a search warrant by using the narcotics-detection trained canine in support of probable cause.

A narcotics-detection trained canine will not be used to search a person for narcotics unless the canine is trained to passively indicate the presence of narcotics.

311.8 HANDLER SELECTION

The minimum qualifications for the assignment of canine handler include:

- (a) An officer who is currently off training.
- (b) Residing in an adequately fenced, single-family residence (minimum 5-foot high fence with locking gates).
- (c) A garage that can be secured and accommodate a canine vehicle.
- (d) Agreeing to be assigned to the position for a minimum of four years.

311.9 HANDLER RESPONSIBILITIES

The canine handler shall ultimately be responsible for the health and welfare of the canine and shall ensure that the canine receives proper nutrition, grooming, training, medical care, affection and healthy living conditions.

The canine handler will be responsible for the following:

- (a) Except as required during appropriate deployment, the handler shall not expose the canine to any foreseeable and unreasonable risk of harm.
- (b) The handler shall maintain all department equipment under his/her control in a clean and serviceable condition.
- (c) When not in service, the handler shall maintain the canine vehicle in a locked garage, away from public view.
- (d) Handlers shall permit the canine coordinator to conduct spontaneous on-site inspections of affected areas of their homes as well as their canine vehicles to verify that conditions and equipment conform to this policy.

Culver City Police Department

Culver City PD Policy Manual

Canines

- (e) Any changes in the living status of the handler that may affect the lodging or environment of the canine shall be reported to the canine coordinator as soon as possible.
- (f) When off-duty, the canine shall be in a kennel provided by the City at the home of the handler. When a canine is kenneled at the handler's home, the gate shall be secured with a lock. When off-duty, the canine may be let out of the kennel while under the direct control of the handler.
- (g) The canine should be permitted to socialize in the home with the handler's family for short periods of time and under the direct supervision of the handler.
- (h) Under no circumstances will the canine be lodged at another location unless approved by the canine coordinator or Watch Commander.
- (i) When off-duty, the handler shall not involve the canine in any law enforcement activity or official conduct unless approved in advance by the canine coordinator or Watch Commander.
- (j) Whenever a canine handler is off-duty for an extended number of days, it may be necessary to temporarily relocate the canine. In those situations, the handler shall give reasonable notice to the canine coordinator so that appropriate arrangements can be made.

311.9.1 CANINE IN PUBLIC AREAS

The canine should be kept on a leash when in areas that allow access to the public. Exceptions to this rule would include specific law enforcement operations for which the canine is trained.

- (a) A canine shall not be left unattended in any area to which the public may have access.
- (b) When the canine vehicle is left unattended, all windows and doors shall be secured in such a manner as to prevent unauthorized access to the canine. The handler shall also ensure that the unattended vehicle remains inhabitable for the canine.

311.10 CANINE INJURY AND MEDICAL CARE

In the event that a canine is injured, or there is an indication that the canine is not in good physical condition, the injury or condition will be reported to the canine coordinator or Watch Commander as soon as practicable and appropriately documented.

All medical attention shall be rendered by the designated canine veterinarian, except during an emergency where treatment should be obtained from the nearest available veterinarian. All records of medical treatment shall be maintained in the handler's personnel file.

311.11 TRAINING

Before assignment in the field, each canine team shall be trained and certified to meet current POST guidelines or other recognized and approved certification standards. Cross-trained canine teams or those canine teams trained exclusively for the detection of narcotics and/or explosives also shall be trained and certified by the California Narcotic Canine Association (CNCA) or other recognized and approved certification standards established for their particular skills.

Culver City Police Department

Culver City PD Policy Manual

Canines

The canine coordinator shall be responsible for scheduling periodic training for all department members in order to familiarize them with how to conduct themselves in the presence of department canines. Because canines may be exposed to dangerous substances such as opioids, as resources are available, the canine coordinator should also schedule periodic training for the canine handlers about the risks of exposure and treatment for it.

All canine training shall be conducted while on-duty unless otherwise approved by the canine coordinator or Watch Commander.

311.11.1 CONTINUED TRAINING

Each canine team shall thereafter be recertified to a current POST, CNCA, or other recognized and approved certification standards on an annual basis. Additional training considerations are as follows:

- (a) Canine teams should receive training as defined in the current contract with the Culver City Police Department canine training provider.
- (b) Canine handlers are encouraged to engage in additional training with approval of the canine coordinator.
- (c) To ensure that all training is consistent, no handler, trainer, or outside vendor is authorized to train to a standard that is not reviewed and approved by the Department.

311.11.2 FAILURE TO SUCCESSFULLY COMPLETE TRAINING

Any canine team failing to graduate or obtain certification shall not be deployed in the field for tasks the team is not certified to perform until graduation or certification is achieved. When reasonably practicable, pending successful certification, the canine handler shall be temporarily reassigned to regular patrol duties.

311.11.3 TRAINING RECORDS

All canine training records shall be maintained in the canine handler's and the canine's training file. All canine training records shall be maintained in the canine handler's training file stored on the department server (Z: Drive). Canine handler(s) shall maintain all training records on Packtrack, a web based program specifically designed for inputting and saving canine handler training records. The canine Sergeant and Lieutenant shall maintain a training group within Packtrack. The canine Sergeant and Lieutenant shall review all training records maintained with Packtrack and ensure all training records are saved into each respective canine handler's training file/ folder within the department server.

311.11.4 TRAINING AIDS

Training aids are required to effectively train and maintain the skills of canines. Officers possessing, using or transporting controlled substances or explosives for canine training purposes must comply with federal and state requirements. Alternatively, the Culver City Police Department may work with outside trainers with the applicable licenses or permits.

Culver City Police Department

Culver City PD Policy Manual

Canines

311.11.5 CONTROLLED SUBSTANCE TRAINING AIDS

Officers acting in the performance of their official duties may possess or transfer controlled substances for the purpose of narcotics-detection canine training in compliance with state and federal laws (Health & Safety Code § 11367.5; 21 USC § 823(g)).

The Chief of Police or the authorized designee may authorize a member to seek a court order to allow controlled substances seized by the Culver City Police Department to be possessed by the member or a narcotics-detection canine trainer who is working under the direction of this department for training purposes, provided the controlled substances are no longer needed as criminal evidence.

As an alternative, the Chief of Police or the authorized designee may request narcotics training aids from the Drug Enforcement Administration (DEA).

These procedures are not required if the canine handler uses commercially available synthetic substances that are not controlled narcotics.

311.11.6 CONTROLLED SUBSTANCE PROCEDURES

Due to the responsibilities and liabilities involved with possessing readily usable amounts of controlled substances and the ever-present danger of the canine's accidental ingestion of these controlled substances, the following procedures shall be strictly followed:

- (a) All controlled substance training samples shall be weighed and tested prior to dispensing to the individual canine handler or trainer.
- (b) The weight and test results shall be recorded and maintained by this department.
- (c) Any person possessing controlled substance training samples pursuant to court order or DEA registration shall maintain custody and control of the controlled substances and shall keep records regarding any loss of, or damage to, those controlled substances.
- (d) All controlled substance training samples will be inspected, weighed, and tested quarterly. The results of the quarterly testing shall be recorded and maintained by the canine coordinator with a copy forwarded to the dispensing agency.
- (e) All controlled substance training samples will be stored in locked, airtight, and watertight cases at all times, except during training. The locked cases shall be secured in the trunk of the canine handler's assigned patrol vehicle during transport and stored in an appropriate locked container. There are no exceptions to this procedure.
- (f) The canine coordinator shall periodically inspect every controlled substance training sample for damage or tampering and take any appropriate action.
- (g) Any unusable controlled substance training samples shall be returned to the Property and Evidence Section or to the dispensing agency.
- (h) All controlled substance training samples shall be returned to the dispensing agency upon the conclusion of the training or upon demand by the dispensing agency.

Culver City Police Department

Culver City PD Policy Manual

Canines

311.11.7 EXPLOSIVE TRAINING AIDS

Officers may possess, transport, store, or use explosives or destructive devices in compliance with state and federal laws (Penal Code § 18800; 18 USC § 842; 27 CFR 555.41).

Explosive training aids designed specifically for canine teams should be used whenever feasible. Due to the safety concerns in the handling and transportation of explosives, inert or non-hazardous training aids should be employed whenever feasible. The use of explosives or destructive devices for training aids by canine teams is subject to the following:

- (a) All explosive training aids, when not in use, shall be properly stored in a secure facility appropriate for the type of materials.
- (b) An inventory ledger shall be maintained to document the type and quantity of explosive training aids that are stored.
- (c) The canine coordinator shall be responsible for verifying the explosive training aids on hand against the inventory ledger once each quarter.
- (d) Only members of the canine team shall have access to the explosive training aids storage facility.
- (e) A primary and secondary custodian will be designated to minimize the possibility of loss of explosive training aids during and after the training. Generally, the handler will be designated as the primary custodian while the trainer or authorized second person on-scene will be designated as the secondary custodian.
- (f) Any lost or damaged explosive training aids shall be promptly reported to the canine coordinator, who will determine if any further action will be necessary. Any loss of explosives will be reported to the Bureau of Alcohol, Tobacco, Firearms and Explosives (ATF).

Domestic Violence

312.1 PURPOSE AND SCOPE

The purpose of this policy is to provide the guidelines necessary to deter, prevent and reduce domestic violence through vigorous enforcement and to address domestic violence as a serious crime against society. The policy specifically addresses the commitment of this department to take enforcement action when appropriate, to provide assistance to victims and to guide officers in the investigation of domestic violence.

312.1.1 DEFINITIONS

Definitions related to this policy include:

Court order - All forms of orders related to domestic violence that have been issued by a court of this state or another, whether civil or criminal, regardless of whether service has been made.

312.2 POLICY

The Culver City Police Department's response to incidents of domestic violence and violations of related court orders shall stress enforcement of the law to protect the victim and shall communicate the philosophy that domestic violence is criminal behavior. It is also the policy of this department to facilitate victims' and offenders' access to appropriate civil remedies and community resources whenever feasible.

312.3 OFFICER SAFETY

The investigation of domestic violence cases often places officers in emotionally charged and sometimes highly dangerous environments. No provision of this policy is intended to supersede the responsibility of all officers to exercise due caution and reasonable care in providing for the safety of any officers and parties involved.

312.4 INVESTIGATIONS

The following guidelines should be followed by officers when investigating domestic violence cases:

- (a) Calls of reported, threatened, imminent, or ongoing domestic violence and the violation of any court order are of extreme importance and should be considered among the highest response priorities. This includes incomplete 9-1-1 calls.
- (b) When practicable, officers should obtain and document statements from the victim, the suspect, and any witnesses, including children, in or around the household or location of occurrence.
- (c) Officers should list the full name and date of birth (and school if available) of each child who was present in the household at the time of the offense. The names of other children who may not have been in the house at that particular time should also be obtained for follow-up.
- (d) When practicable and legally permitted, video or audio record all significant statements and observations.

Culver City Police Department

Culver City PD Policy Manual

Domestic Violence

- (e) All injuries should be photographed, regardless of severity, taking care to preserve the victim's personal privacy. Where practicable, photographs should be taken by a person of the same sex. Victims whose injuries are not visible at the time of the incident should be asked to contact the Detective Bureau in the event that the injuries later become visible.
- (f) Officers should request that the victim complete and sign an authorization for release of medical records related to the incident when applicable.
- (g) If the suspect is no longer at the scene, officers should make reasonable efforts to locate the suspect to further the investigation, provide the suspect with an opportunity to make a statement, and make an arrest or seek an arrest warrant if appropriate.
- (h) Seize any firearms or other dangerous weapons in the home, if appropriate and legally permitted, for safekeeping or as evidence. If the domestic violence involved threats of bodily harm, any firearm discovered in plain view or pursuant to consent or other lawful search must be taken into temporary custody (Penal Code § 18250).
- (i) When completing an incident or arrest report for violation of a court order, officers should include specific information that establishes that the offender has been served, including the date the offender was served, the name of the agency that served the order, and the provision of the order that the subject is alleged to have violated. When reasonably available, the arresting officer should attach a copy of the order to the incident or arrest report.
- (j) Officers should take appropriate enforcement action when there is probable cause to believe an offense has occurred. Factors that should not be used as sole justification for declining to take enforcement action include:
 - 1. Whether the suspect lives on the premises with the victim.
 - 2. Claims by the suspect that the victim provoked or perpetuated the violence.
 - 3. The potential financial or child custody consequences of arrest.
 - 4. The physical or emotional state of either party.
 - 5. Use of drugs or alcohol by either party.
 - 6. Denial that the abuse occurred where evidence indicates otherwise.
 - 7. A request by the victim not to arrest the suspect.
 - 8. Location of the incident (public/private).
 - 9. Speculation that the complainant may not follow through with the prosecution.
 - 10. Actual or perceived characteristics such as race, ethnicity, national origin, religion, sex, sexual orientation, gender identity or expression, economic status, age, cultural group, disability, or marital status of the victim or suspect.
 - 11. The social status, community status, or professional position of the victim or suspect.

312.4.1 IF A SUSPECT IS ARRESTED

If a suspect is arrested, officers should:

Culver City Police Department

Culver City PD Policy Manual

Domestic Violence

- (a) Advise the victim that there is no guarantee the suspect will remain in custody.
- (b) Provide the victim's contact information to the jail staff to enable notification of the victim upon the suspect's release from jail.
- (c) Advise the victim whether any type of court order will be in effect when the suspect is released from jail.

312.4.2 IF NO ARREST IS MADE

If no arrest is made, the officer should:

- (a) Advise the parties of any options, including but not limited to:
 - 1. Voluntary separation of the parties.
 - 2. Appropriate resource referrals (e.g., counselors, friends, relatives, shelter homes, victim witness unit).
- (b) Document the resolution in a report.

312.4.3 ARRESTING OFFICERS' RESPONSIBILITIES REGARDING FIREARMS

If a suspect is arrested, officers shall (Penal Code § 273.76):

- (a) Query the Automated Firearms System through the California Law Enforcement Telecommunications System (CLETS) for any firearms owned or possessed by the arrestee.
 - 1. The investigating or filing officer shall include a copy of the Automated Firearms System report when filing the case with the district attorney or prosecuting city attorney.
- (b) Ask the arrestee, victim, and any other household members, if applicable, about any firearms owned or possessed by the arrestee.
- (c) Ensure that any firearm or other deadly weapon in plain sight or discovered pursuant to a consensual or other lawful search is taken into temporary custody pursuant to Penal Code § 18250.
- (d) Document in the arrest report the detailed actions taken required by Penal Code § 273.76.

312.5 VICTIM ASSISTANCE

Because victims may be traumatized or confused, officers should be aware that a victim's behavior and actions may be affected:

- (a) Victims should be provided with the department's domestic violence information handout, even if the incident may not rise to the level of a crime.
- (b) Victims should also be alerted to any available victim advocates, shelters, and community resources.
- (c) When an involved person requests law enforcement assistance while removing essential items of personal property, officers should stand by for a reasonable amount of time.

Culver City Police Department

Culver City PD Policy Manual

Domestic Violence

- (d) If the victim has sustained injury or complaints of pain, officers should seek medical assistance as soon as practicable.
- (e) Officers should ask the victim whether the victim has a safe place to stay and assist in arranging transportation to an alternate shelter if the victim expresses a concern for the victim's safety or if the officer determines that a need exists.
- (f) Officers should make reasonable efforts to ensure that children or dependent adults who are under the supervision of the suspect or victim are being properly cared for.
- (g) If appropriate, officers should seek or assist the victim in obtaining an emergency order if appropriate.

An officer shall advise an individual protected by a Canadian domestic violence protection order of available local victim services (Family Code § 6452).

312.6 DISPATCH ASSISTANCE

All calls of domestic violence, including incomplete 9-1-1 calls, should be dispatched as soon as practicable.

Dispatchers are not required to verify the validity of a court order before responding to a request for assistance. Officers should request that dispatchers check whether any of the involved persons are subject to the terms of a court order.

312.7 FOREIGN COURT ORDERS

Various types of orders may be issued in domestic violence cases. Any foreign court order properly issued by a court of another state, Indian tribe, or territory shall be enforced by officers as if it were the order of a court in this state. An order should be considered properly issued when it reasonably appears that the issuing court has jurisdiction over the parties and reasonable notice and opportunity to respond was given to the party against whom the order was issued (18 USC § 2265). An otherwise valid out-of-state court or foreign order shall be enforced, regardless of whether the order has been properly registered with this state (Family Code § 6403).

Canadian domestic violence protection orders shall also be enforced in the same manner as if issued in this state (Family Code § 6452).

312.8 VERIFICATION OF COURT ORDERS

Determining the validity of a court order, particularly an order from another jurisdiction, can be challenging. Therefore, in determining whether there is probable cause to make an arrest for a violation of any court order, officers should carefully review the actual order when available, and where appropriate and practicable:

- (a) Ask the subject of the order about his/her notice or receipt of the order, his/her knowledge of its terms and efforts to respond to the order.
 1. If a determination is made that a valid foreign order cannot be enforced because the subject has not been notified or served the order, the officer shall inform the subject of the order, make a reasonable effort to serve the order upon the subject, and allow the subject a reasonable opportunity to comply with the order

Culver City Police Department

Culver City PD Policy Manual

Domestic Violence

before enforcing the order. Verbal notice of the terms of the order is sufficient notice (Family Code § 6403).

- (b) Check available records or databases that may show the status or conditions of the order.
 - 1. Registration or filing of an order in California is not required for the enforcement of a valid foreign order (Family Code § 6403).
- (c) Contact the issuing court to verify the validity of the order.
- (d) Contact a law enforcement official from the jurisdiction where the order was issued to verify information.

Officers should document in an appropriate report their efforts to verify the validity of an order, regardless of whether an arrest is made. Officers should contact a supervisor for clarification when needed.

312.9 STANDARDS FOR ARRESTS

Officers investigating a domestic violence report should consider the following:

- (a) An arrest should be made when there is probable cause to believe that a felony or misdemeanor domestic violence offense has been committed (Penal Code § 13701). Any decision to not arrest an adult when there is probable cause to do so requires supervisor approval.
 - 1. Officers are only authorized to make an arrest without a warrant for a misdemeanor domestic violence offense if the officer makes the arrest as soon as probable cause arises (Penal Code § 836).
- (b) An officer responding to a domestic violence call who cannot make an arrest will advise the victim of the victim's right to make a private person's arrest. The advisement should be made out of the presence of the suspect and shall include advising the victim how to safely execute the arrest. Officers shall not dissuade victims from making a lawful private person's arrest. Officers should refer to the provisions in the Private Persons Arrests Policy for options regarding the disposition of private person's arrests (Penal Code § 836(b)).
- (c) Officers shall not cite and release a person for the following offenses (Penal Code § 853.6(a)(3)):
 - 1. Penal Code § 243(e)(1) (battery against spouse, cohabitant)
 - 2. Penal Code § 273.5 (corporal injury on spouse, cohabitant, fiancé/fiancée, person of a previous dating or engagement relationship, mother/father of the offender's child)
 - 3. Penal Code § 273.6 (violation of protective order) if violence or threats of violence have occurred or the suspect has gone to the workplace or residence of the protected party
 - 4. Penal Code § 646.9 (stalking)
 - 5. Other serious or violent felonies specified in Penal Code § 1270.1

Culver City Police Department

Culver City PD Policy Manual

Domestic Violence

- (d) In responding to domestic violence incidents, including mutual protective order violations, officers should generally be reluctant to make dual arrests. Officers shall make reasonable efforts to identify the dominant aggressor in any incident. The dominant aggressor is the person who has been determined to be the most significant, rather than the first, aggressor (Penal Code § 13701). In identifying the dominant aggressor, an officer shall consider:
 - 1. The intent of the law to protect victims of domestic violence from continuing abuse.
 - 2. The threats creating fear of physical injury.
 - 3. The history of domestic violence between the persons involved.
 - 4. Whether either person acted in self-defense.
- (e) An arrest shall be made when there is probable cause to believe that a violation of a domestic violence court order has been committed (Penal Code § 13701; Penal Code § 836), regardless of whether the offense was committed in the officer's presence. After arrest, the officer shall confirm that a copy of the order has been registered, unless the victim provides a copy (Penal Code § 836).

312.10 REPORTS AND RECORDS

- (a) A written report shall be completed on all incidents of domestic violence. All such reports should be documented on the appropriate form, which includes information and notations specific to domestic violence incidents as required by Penal Code § 13730.
- (b) Reporting officers should provide the victim with the case number of the report. The case number may be placed in the space provided on the domestic violence victim information handout provided to the victim. If the case number is not immediately available, an explanation should be given regarding how the victim can obtain the information at a later time.
- (c) Officers who seize any firearm, ammunition, or other deadly weapon in a domestic violence incident shall issue the individual possessing such weapon a receipt that includes the name and residential mailing address of the owner or person who possessed the weapon and notice of where the weapon may be recovered, along with the applicable time limit for recovery (Penal Code § 18250; Penal Code § 18255; Penal Code § 33800; Family Code § 6389(c)).

312.11 RECORD-KEEPING AND DATA COLLECTION

This department shall maintain records of court orders related to domestic violence and the service status of each (Penal Code § 13710), as well as records on the number of domestic violence related calls reported to the Department, including whether weapons were used in the incident or whether the incident involved strangulation or suffocation (Penal Code § 13730). This information is to be reported to the Attorney General monthly. It shall be the responsibility of the Records Supervisor to maintain and report this information as required.

Culver City Police Department

Culver City PD Policy Manual

Domestic Violence

312.12 SERVICE OF COURT ORDERS

- (a) An officer who obtains an emergency protective order from the court shall serve it on the restrained person if the person can be reasonably located and shall provide the person protected or the person's parent/guardian with a copy of the order. The officer shall file a copy with the court as soon as practicable and shall have the order entered into the computer database system for protective and restraining orders maintained by the Department of Justice (Family Code § 6271; Penal Code § 646.91).
- (b) A temporary restraining order, emergency protective order, or an order issued after a hearing shall, at the request of the petitioner, be served on the restrained person by an officer who is present at the scene of a reported domestic violence incident or when the officer receives a request from the petitioner to provide service of the order (Family Code § 6383; Penal Code § 13710).
- (c) Any officer serving a protective order that indicates that the respondent possesses weapons or ammunition shall request that the firearm/ammunition be immediately surrendered (Family Code § 6389(c)).
- (d) During the service of a protective order any firearm discovered in plain view or pursuant to consent or other lawful search shall be taken into temporary custody (Penal Code § 18250).
 - 1. An officer should ensure that the Records Section is notified of any firearm obtained for entry into the Automated Firearms System (Family Code § 6383) (see the Records Section Policy for additional guidance).
- (e) If a valid Canadian order cannot be enforced because the person subject to the order has not been notified or served with the order, the officer shall notify the protected individual that reasonable efforts shall be made to contact the person subject to the order. The officer shall make a reasonable effort to inform the person subject to the order of the existence and terms of the order and provide the person with a record of the order, if available, and shall allow the person a reasonable opportunity to comply with the order before taking enforcement action (Family Code § 6452).

312.13 PUBLIC ACCESS TO POLICY

A copy of this domestic violence policy will be provided to members of the public upon request (Penal Code § 13701).

312.14 DECLARATION IN SUPPORT OF BAIL INCREASE

Any officer who makes a warrantless arrest for a felony or misdemeanor violation of a domestic violence restraining order shall evaluate the totality of the circumstances to determine whether reasonable cause exists to seek an increased bail amount. If there is reasonable cause to believe that the scheduled bail amount is insufficient to assure the arrestee's appearance or to protect the victim or family member of a victim, the officer shall prepare a declaration in support of increased bail (Penal Code § 1269c).

Culver City Police Department

Culver City PD Policy Manual

Domestic Violence

312.15 DOMESTIC VIOLENCE DEATH REVIEW TEAM

This department should cooperate with any interagency domestic violence death review team investigation. Written and oral information relating to a domestic violence death that would otherwise be subject to release restrictions may be disclosed to the domestic violence death review team upon written request and approval of a supervisor (Penal Code § 11163.3).

Search and Seizure

313.1 PURPOSE AND SCOPE

Both the federal and state Constitutions provide every individual with the right to be free from unreasonable searches and seizures. This policy provides general guidelines for Culver City Police Department personnel to consider when dealing with search and seizure issues.

313.2 POLICY

It is the policy of the Culver City Police Department to respect the fundamental privacy rights of individuals. Members of this department will conduct searches in strict observance of the constitutional rights of persons being searched. All seizures by this department will comply with relevant federal and state law governing the seizure of persons and property.

The Department will provide relevant and current training to officers as guidance for the application of current law, local community standards and prosecutorial considerations regarding specific search and seizure situations, as appropriate.

313.3 SEARCHES

The U.S. Constitution generally provides that a valid warrant is required in order for a search to be valid. There are, however, several exceptions that permit a warrantless search.

Examples of law enforcement activities that are exceptions to the general warrant requirement include, but are not limited to, searches pursuant to the following:

- Valid consent
- Incident to a lawful arrest
- Legitimate community caretaking interests (see section 502 Vehicle Towing and Release for some restrictions)
- Vehicle searches under certain circumstances
- Exigent circumstances

Certain other activities are recognized by federal and state courts and by certain statutes as legitimate law enforcement activities that also do not require a warrant. Such activities may include seizure and examination of abandoned property, and observations of activities and property located on open public areas.

Because case law regarding search and seizure is constantly changing and subject to interpretation by the courts, each member of this department is expected to act in each situation according to current training and his/her familiarity with clearly established rights as determined by case law.

Whenever practicable, officers are encouraged to contact a supervisor to resolve questions regarding search and seizure issues prior to electing a course of action.

Culver City Police Department

Culver City PD Policy Manual

Search and Seizure

313.4 SEARCH PROTOCOL

Although conditions will vary and officer safety and other exigencies must be considered in every search situation, the following guidelines should be followed whenever circumstances permit:

- (a) Members of this department will strive to conduct searches with dignity and courtesy.
- (b) Officers should explain to the person being searched the reason for the search and how the search will be conducted.
- (c) Searches should be carried out with due regard and respect for private property interests and in a manner that minimizes damage. Property should be left in a condition as close as reasonably possible to its pre-search condition.
- (d) In order to minimize the need for forcible entry, an attempt should be made to obtain keys, combinations or access codes when a search of locked property is anticipated.
- (e) When the person to be searched is of the opposite sex as the searching officer, a reasonable effort should be made to summon an officer of the same sex as the subject to conduct the search. When it is not practicable to summon an officer of the same sex as the subject, the following guidelines should be followed:
 1. Another officer or a supervisor should witness the search.
 2. The officer should not search areas of the body covered by tight-fitting clothing, sheer clothing or clothing that could not reasonably conceal a weapon.
- (f) When an employee/Officer must conduct a search of an individual they have reason to believe is transgender or non-binary, the transgender or non-binary individual shall be asked their preference concerning the gender of the member searching them. For example, "What gender employee/Officer would you prefer to search you?" If the transgender or non-binary individual's request can be reasonably and expeditiously accommodated without risk to employee/Officer safety, the request should be granted.
 1. If a member of the transgender or non-binary individual's preferred gender is not available, the search can be conducted by the employee/Officer on scene.
 - (a) The search of a transgender or non-binary individual shall be conducted with a witness employee/Officer present.
 - (b) When feasible, employees/Officers shall obtain Supervisory approval prior to conducting a search of a transgender or non-binary individual.

313.5 DOCUMENTATION

When applicable, officers are responsible to document any search and to ensure that any required reports are sufficient including, at minimum, documentation of the following:

- Reason for the search
- Any efforts used to minimize the intrusiveness of any search (e.g., asking for consent or keys)
- What, if any, injuries or damage occurred
- All steps taken to secure property

Culver City Police Department

Culver City PD Policy Manual

Search and Seizure

- The results of the search, including a description of any property or contraband seized
- If the person searched is the opposite sex, any efforts to summon an officer of the same sex as the person being searched and the identification of any witness officer

Supervisors shall review reports to ensure the reports are accurate, that actions are properly documented and that current legal requirements and department policy have been met.

Temporary Custody of Juveniles

314.1 PURPOSE AND SCOPE

This policy provides guidelines consistent with the Juvenile Justice and Delinquency Prevention Act for juveniles taken into temporary custody by members of the Culver City Police Department (34 USC § 11133).

Guidance regarding contacting juveniles at schools or who may be victims is provided in the Child Abuse Policy.

314.1.1 DEFINITIONS

Definitions related to this policy include:

Juvenile non-offender - An abused, neglected, dependent, or alien juvenile who may be legally held for the juvenile's own safety or welfare. This also includes any juvenile who may have initially been contacted for an offense that would not subject an adult to arrest (e.g., fine-only offense) but was taken into custody for the juvenile's protection or for purposes of reuniting the juvenile with a parent, guardian, or other responsible person. Juveniles 11 years of age or younger are considered juvenile non-offenders even if they have committed an offense that would subject an adult to arrest.

Juvenile offender - A juvenile 12 to 17 years of age who is alleged to have committed an offense that would subject an adult to arrest (a non-status offense) (Welfare and Institutions Code § 602). It also includes an offense under Penal Code § 29610 for underage possession of a handgun or concealable firearm (28 CFR 31.303).

Non-secure custody - When a juvenile is held in the presence of an officer or other custody employee at all times and is not placed in a locked room, cell, or behind any locked doors. Juveniles in non-secure custody may be handcuffed but not to a stationary or secure object. Personal supervision, through direct visual monitoring and audio two-way communication is maintained. Monitoring through electronic devices, such as video, does not replace direct visual observation (Welfare and Institutions Code § 207.1; 15 CCR 1150).

Safety checks - Direct, visual observation personally by a member of this department performed at random intervals within time frames prescribed in this policy to provide for the health and welfare of juveniles in temporary custody.

Secure custody - When a juvenile offender is held in a locked room, a set of rooms, or a cell. Secure custody also includes being physically secured to a stationary object (15 CCR 1146).

Examples of secure custody include:

- (a) A juvenile left alone in an unlocked room within the secure perimeter of the adult temporary holding area.
- (b) A juvenile handcuffed to a rail.

Culver City Police Department

Culver City PD Policy Manual

Temporary Custody of Juveniles

- (c) A juvenile placed in a room that contains doors with delayed egress devices that have a delay of more than 30 seconds.
- (d) A juvenile being processed in a secure booking area when a non-secure booking area is available.
- (e) A juvenile left alone in a secure booking area after being photographed and fingerprinted.
- (f) A juvenile placed in a cell within the adult temporary holding area, whether or not the cell door is locked.
- (g) A juvenile placed in a room that is capable of being locked or contains a fixed object designed for cuffing or restricting movement.

Sight and sound separation - Located or arranged to prevent physical, visual, or auditory contact that is more than brief or inadvertent.

Status offender - A juvenile suspected of committing a criminal violation of the law that would not be a criminal violation but for the age of the offender. Examples may include running away, underage possession of tobacco, curfew violation, and truancy. A juvenile in custody on a court order or warrant based upon a status offense is also a status offender. This includes the habitually disobedient or truant juvenile under Welfare and Institutions Code § 601 and any juvenile suspected of an offense that would not subject an adult to arrest (e.g., fine-only offense).

314.2 POLICY

The Culver City Police Department is committed to releasing juveniles from temporary custody as soon as reasonably practicable and keeping juveniles safe while they are in temporary custody at the Culver City Police Department. Juveniles should be held in temporary custody only for as long as reasonably necessary for processing, transfer, or release.

314.3 JUVENILES WHO SHOULD NOT BE HELD

Juveniles who exhibit any of the following conditions should not be held at the Culver City Police Department:

- (a) Unconscious
- (b) Seriously injured
- (c) A known suicide risk or obviously severely emotionally disturbed
- (d) Significantly intoxicated except when approved by the Watch Commander. A medical clearance shall be obtained for minors who are under the influence of drugs, alcohol, or any other intoxicating substance to the extent that they are unable to care for themselves (15 CCR 1151).
- (e) Extremely violent or continuously violent

Officers taking custody of a juvenile who exhibits any of the above conditions should take reasonable steps to provide medical attention or mental health assistance and notify a supervisor of the situation (15 CCR 1142; 15 CCR 1151).

Culver City Police Department

Culver City PD Policy Manual

Temporary Custody of Juveniles

These juveniles should not be held at the Culver City Police Department unless they have been evaluated by a qualified medical and/or mental health professional (15 CCR 1142).

If the officer taking custody of the juvenile believes the juvenile may be a suicide risk, the juvenile shall be under continuous direct supervision until evaluation, release, or a transfer is completed (15 CCR 1142).

314.3.1 EMERGENCY MEDICAL CARE OF JUVENILES IN CUSTODY

When emergency medical attention is required for a juvenile, medical assistance will be called immediately. The Watch Commander shall be notified of the need for medical attention for the juvenile. Department members should administer first aid as applicable (15 CCR 1142).

314.3.2 SUICIDE PREVENTION OF JUVENILES IN CUSTODY

Department members should be alert to potential symptoms based upon exhibited behavior that may indicate the juvenile is a suicide risk. These symptoms may include depression, refusal to communicate, verbally threatening to kill themselves, or any unusual behavior which may indicate the juvenile may harm themselves while in either secure or non-secure custody (15 CCR 1142).

314.4 CUSTODY OF JUVENILES

Officers should take custody of a juvenile and temporarily hold the juvenile at the Culver City Police Department when there is no other lawful and practicable alternative to temporary custody. Refer to the Child Abuse Policy for additional information regarding detaining a juvenile that is suspected of being a victim.

No juvenile should be held in temporary custody at the Culver City Police Department without authorization of the arresting officer's supervisor or the Watch Commander. Juveniles taken into custody shall be held in non-secure custody unless otherwise authorized by this policy.

Any juvenile taken into custody shall be released to the care of the juvenile's parent or other responsible adult or transferred to a juvenile custody facility or to other authority as soon as practicable and in no event shall a juvenile be held beyond six hours from the time of the juvenile's entry into the Culver City Police Department (34 USC § 11133; Welfare and Institutions Code § 207.1).

314.4.1 CUSTODY OF JUVENILE NON-OFFENDERS

Non-offenders taken into protective custody in compliance with the Child Abuse Policy should generally not be held at the Culver City Police Department. Custodial arrangements should be made for non-offenders as soon as reasonably possible. Juvenile non-offenders shall not be held in secure custody (34 USC § 11133; Welfare and Institutions Code § 206).

Juveniles 11 years of age or younger who have committed an offense that would subject an adult to arrest may be held in non-secure custody for the offenses listed in Welfare and Institutions Code § 602(b) (murder and the sexual assault offenses) and should be referred to a probation officer for a placement determination (Welfare and Institutions Code § 602.1).

Culver City Police Department

Culver City PD Policy Manual

Temporary Custody of Juveniles

314.4.2 CUSTODY OF JUVENILE STATUS OFFENDERS

Status offenders should generally be released by citation or with a warning rather than taken into temporary custody. However, officers may take custody of a status offender if requested to do so by a parent or legal guardian in order to facilitate reunification (e.g., transported home or to the station to await a parent). Juvenile status offenders shall not be held in secure custody (34 USC § 11133).

314.4.3 CUSTODY OF JUVENILE OFFENDERS

Juvenile offenders should be held in non-secure custody while at the Culver City Police Department unless another form of custody is authorized by this policy or is necessary due to exigent circumstances.

Generally, a juvenile offender may be taken into custody when authorized by a court order or when there is probable cause to believe the juvenile has committed an offense that would subject an adult to arrest (Welfare and Institutions Code § 625).

A juvenile offender who is 14 years of age or older and taken into custody for committing or attempting to commit a felony with a firearm shall not be released and be transported to a juvenile facility (Welfare and Institutions Code § 625.3).

A juvenile offender suspected of committing murder, a sex offense described in Welfare and Institutions Code § 602(b) that may subject the juvenile to criminal jurisdiction under Welfare and Institutions Code § 707, or a serious or violent felony should be referred to a probation officer for a decision on further detention.

In all other cases the juvenile offender may be:

- (a) Released upon warning or citation.
- (b) Released to a parent or other responsible adult after processing at the Department.
- (c) Referred to a probation officer for a decision regarding whether to transport the juvenile offender to a juvenile facility.
- (d) Transported to the juvenile offender's home or to the place where the juvenile offender was taken into custody (Welfare and Institutions Code § 207.2).

In determining which disposition is appropriate, the investigating officer or supervisor shall prefer the alternative that least restricts the juvenile's freedom of movement, provided that alternative is compatible with the best interests of the juvenile and the community (Welfare and Institutions Code § 626).

Whenever a juvenile offender under the age of 14 is taken into custody, the officer should take reasonable steps to verify and document the child's ability to differentiate between right and wrong, particularly in relation to the alleged offense (Penal Code § 26).

Culver City Police Department

Culver City PD Policy Manual

Temporary Custody of Juveniles

314.5 ADVISEMENTS

Officers shall take immediate steps to notify the juvenile's parent, guardian, or a responsible relative that the juvenile is in custody, the location where the juvenile is being held, and the intended disposition (Welfare and Institutions Code § 627).

Whenever a juvenile is taken into temporary custody, the juvenile shall be given the *Miranda* rights advisement regardless of whether questioning is intended. This does not apply to juvenile non-offenders taken into temporary custody for their safety or welfare (Welfare and Institutions Code § 625).

Anytime a juvenile offender is placed in secure custody, the juvenile offender shall be informed of the purpose of the secure custody, the length of time the secure custody is expected to last, and of the maximum six-hour limitation (Welfare and Institutions Code § 207.1).

Juveniles taken into custody for an offense shall immediately be advised (or at least within one hour from being taken into custody, if possible) that they may make three telephone calls: one call completed to their parent or guardian; one to a responsible relative or their employer; and another call completed to an attorney. The calls shall be at no expense to the juvenile when completed to telephone numbers within the local calling area. Juveniles should be asked whether they are a caregiver and provided two more phone calls in the same manner as provided to adults in the Temporary Custody of Adults Policy (Welfare and Institutions Code § 627; Penal Code § 851.5).

314.6 JUVENILE CUSTODY LOGS

Any time a juvenile is held in custody at the Department, the custody shall be promptly and properly documented in the juvenile custody log, including:

- (a) Identifying information about the juvenile.
- (b) Date and time of arrival and release from the Culver City Police Department (15 CCR 1150).
- (c) Watch Commander notification and approval to temporarily hold the juvenile.
- (d) Any charges for which the juvenile is being held and classification of the juvenile as a juvenile offender, status offender, or non-offender.
- (e) Any changes in status (e.g., emergency situations, unusual incidents).
- (f) Time of all safety checks.
- (g) Any medical and other screening requested and completed (15 CCR 1142).
- (h) Circumstances that justify any secure custody (Welfare and Institutions Code § 207.1; 15 CCR 1145).
- (i) Any other information that may be required by other authorities, such as compliance inspectors or a local juvenile court authority.

The Watch Commander shall initial the log to approve the custody, including any secure custody, and shall also initial the log when the juvenile is released.

Culver City Police Department

Culver City PD Policy Manual

Temporary Custody of Juveniles

314.7 NO-CONTACT REQUIREMENTS

Sight and sound separation shall be maintained between all juveniles and adults while in custody at the Department (34 USC § 11133; Welfare and Institutions Code § 207.1; Welfare and Institutions Code § 208; 15 CCR 1144). There should also be sight and sound separation between non-offenders and juvenile and status offenders.

In situations where brief or accidental contact may occur (e.g., during the brief time a juvenile is being fingerprinted and/or photographed in booking), a member of the Culver City Police Department (trained in the supervision of persons in custody) shall maintain a constant, immediate, side-by-side presence with the juvenile or the adult to minimize any contact. If inadvertent or accidental contact does occur, reasonable efforts shall be taken to end the contact (15 CCR 1144).

314.8 TEMPORARY CUSTODY REQUIREMENTS

Members and supervisors assigned to monitor or process any juvenile at the Culver City Police Department shall ensure the following:

- (a) The Watch Commander should be notified if it is anticipated that a juvenile may need to remain at the Culver City Police Department more than four hours. This will enable the Watch Commander to ensure no juvenile is held at the Culver City Police Department more than six hours.
- (b) A staff member of the same sex shall supervise personal hygiene activities and care, such as changing clothing or using the restroom, without direct observation to allow for privacy.
- (c) Personal safety checks and significant incidents/activities shall be noted on the log.
- (d) Juveniles in custody are informed that they will be monitored at all times, except when using the toilet.
 1. There shall be no viewing devices, such as peep holes or mirrors, of which the juvenile is not aware.
 2. This does not apply to surreptitious and legally obtained recorded interrogations.
- (e) Juveniles shall have reasonable access to toilets and wash basins (15 CCR 1143).
- (f) Juveniles shall be provided sanitary napkins, panty liners, and tampons as requested (15 CCR 1143).
- (g) Food shall be provided if a juvenile has not eaten within the past four hours or is otherwise in need of nourishment, including any special diet required for the health of the juvenile (15 CCR 1143).
- (h) Juveniles shall have reasonable access to a drinking fountain or water (15 CCR 1143).
- (i) Juveniles shall have reasonable opportunities to stand and stretch, particularly if handcuffed or restrained in any way.
- (j) Juveniles shall have privacy during family, guardian, and/or lawyer visits (15 CCR 1143).

Culver City Police Department

Culver City PD Policy Manual

Temporary Custody of Juveniles

- (k) Juveniles shall be permitted to remain in their personal clothing unless the clothing is taken as evidence or is otherwise unsuitable or inadequate for continued wear while in custody (15 CCR 1143).
- (l) Blankets shall be provided as reasonably necessary (15 CCR 1143).
 - 1. The supervisor should ensure that there is an adequate supply of clean blankets.
- (m) Adequate shelter, heat, light, and ventilation should be provided without compromising security or enabling escape.
- (n) Juveniles shall have adequate furnishings, including suitable chairs or benches.
- (o) Juveniles shall have the right to the same number of telephone calls as an adult in temporary custody.
- (p) Juveniles shall have access to language services (15 CCR 1143).
- (q) Juveniles shall have access to disability services (15 CCR 1143).
- (r) No discipline may be administered to any juvenile, nor may juveniles be subjected to corporal or unusual punishment, humiliation, or mental abuse (15 CCR 1142).

While held in temporary custody, juveniles shall be informed in writing of what is available to them pursuant to 15 CCR 1143 and it shall be posted in at least one conspicuous place to which they have access (15 CCR 1143).

314.9 USE OF RESTRAINT DEVICES

Juvenile offenders may be handcuffed in accordance with the Handcuffing and Restraints Policy. A juvenile offender may be handcuffed at the Culver City Police Department when the juvenile presents a heightened risk. However, non-offenders and status offenders should not be handcuffed unless they are combative or threatening (15 CCR 1142).

Other restraints shall only be used after less restrictive measures have failed and with the approval of the Watch Commander. Restraints shall only be used so long as it reasonably appears necessary for the juvenile's protection or the protection of others (15 CCR 1142).

Juveniles in restraints shall be kept away from other unrestrained juveniles or monitored in such a way as to protect the juvenile from abuse (15 CCR 1142).

314.10 PERSONAL PROPERTY

The officer taking custody of a juvenile offender or status offender at the Culver City Police Department shall ensure a thorough search of the juvenile's property is made and all property is removed from the juvenile, especially those items that could compromise safety, such as pens, pencils, and belts.

The personal property of a juvenile should be placed in a property bag. The property should be inventoried in the juvenile's presence and sealed into the bag. The property should be kept in a monitored or secure location until the juvenile is released from the custody of the Culver City Police Department.

Culver City Police Department

Culver City PD Policy Manual

Temporary Custody of Juveniles

314.11 SECURE CUSTODY

Only juvenile offenders 14 years of age or older may be placed in secure custody (Welfare and Institutions Code § 207; 15 CCR 1145). Watch Commander approval is required before placing a juvenile offender in secure custody.

Secure custody should only be used for juvenile offenders when there is a reasonable belief that the juvenile is a serious risk of harm to themselves or others. Factors to be considered when determining if the juvenile offender presents a serious security risk to themselves or others include the following (15 CCR 1145):

- (a) Age, maturity, and delinquent history
- (b) Severity of offense for which the juvenile was taken into custody
- (c) The juvenile offender's behavior
- (d) Availability of staff to provide adequate supervision or protection of the juvenile offender
- (e) Age, type, and number of other individuals in custody at the facility

Members of this department shall not use secure custody for convenience when non-secure custody is, or later becomes, a reasonable option (15 CCR 1145).

When practicable and when no locked enclosure is available, handcuffing one hand of a juvenile offender to a fixed object while otherwise maintaining the juvenile in non-secure custody should be considered as the method of secure custody. An employee must be present at all times to ensure the juvenile's safety while secured to a stationary object (15 CCR 1148).

Juveniles shall not be secured to a stationary object for more than 60 minutes. Supervisor approval is required to secure a juvenile to a stationary object for longer than 60 minutes and every 30 minutes thereafter (15 CCR 1148). Supervisor approval should be documented.

The decision for securing a minor to a stationary object for longer than 60 minutes and every 30 minutes thereafter shall be based upon the best interests of the juvenile offender (15 CCR 1148).

314.11.1 LOCKED ENCLOSURES

A thorough inspection of the area shall be conducted before placing a juvenile into the enclosure. A second inspection shall be conducted after removing the juvenile. Any damage noted to the room should be photographed and documented in the crime report.

The following requirements shall apply to a juvenile offender who is held inside a locked enclosure:

- (a) The juvenile shall constantly be monitored by an audio/video system during the entire custody.
- (b) Juveniles shall have constant auditory access to department members (15 CCR 1147).
- (c) Initial placement into and removal from a locked enclosure shall be logged (Welfare and Institutions Code § 207.1).

Culver City Police Department

Culver City PD Policy Manual

Temporary Custody of Juveniles

- (d) Unscheduled safety checks to provide for the health and welfare of the juvenile by a staff member, no less than once every 15 minutes, shall occur (15 CCR 1147; 15 CCR 1151).
 - 1. All safety checks shall be logged.
 - 2. The safety check should involve questioning the juvenile as to the juvenile's well-being (sleeping juveniles or apparently sleeping juveniles should be awakened).
 - 3. Requests or concerns of the juvenile should be logged.
- (e) Juveniles of different genders shall not be placed in the same locked room (15 CCR 1147).
- (f) Juvenile offenders should be separated according to severity of the crime (e.g., felony or misdemeanor).
- (g) Restrained juveniles shall not be mixed in a cell or room with unrestrained juveniles.

314.12 SUICIDE ATTEMPT, DEATH, OR SERIOUS INJURY OF A JUVENILE

The Watch Commander will ensure procedures are in place to address the suicide attempt, death, or serious injury of any juvenile held at the Culver City Police Department (15 CCR 1142; 15 CCR 1047). The procedures will address:

- (a) Immediate notification of the on-duty supervisor, Chief of Police, and Investigations Bureau Bureau Supervisor.
- (b) Notification of the parent, guardian, or person standing in loco parentis of the juvenile.
- (c) Notification of the appropriate prosecutor.
- (d) Notification of the City attorney.
- (e) Notification to the coroner.
- (f) Notification of the juvenile court.
- (g) In the case of a death, providing a report to the Attorney General under Government Code § 12525 within 10 calendar days of the death, and forwarding the same report to the Board of State and Community Corrections (BSCC) within the same time frame (15 CCR 1046).
- (h) A medical and operational review of deaths pursuant to 15 CCR 1046.
 - 1. A copy of the review report shall be provided to BSCC within 60 days of the death (15 CCR 1046).
- (i) Evidence preservation.

314.12.1 IN-CUSTODY DEATH PUBLICATION

The Chief of Police or the authorized designee should ensure that specified information relating to an in-custody death of a juvenile is posted on the department website as prescribed and within the time frames provided in Penal Code § 10008.

Culver City Police Department

Culver City PD Policy Manual

Temporary Custody of Juveniles

314.13 INTERVIEWING OR INTERROGATING JUVENILE SUSPECTS

No interview or interrogation of a juvenile should occur unless the juvenile has the apparent capacity to consent, and does consent, to an interview or interrogation.

Prior to conducting a custodial interrogation, including the waiver of *Miranda* rights, an officer shall permit a juvenile 17 years of age or younger to consult with legal counsel in person, by telephone, or by video conference. The consultation may not be waived by the juvenile (Welfare and Institutions Code § 625.6).

Threats, physical harm, deception, or psychologically manipulative interrogation tactics shall not be used by an officer during a custodial interrogation of a juvenile (Welfare and Institutions Code § 625.7).

The requirements to consult with legal counsel or to refrain from the use of prohibited interrogation techniques do not apply when (Welfare and Institutions Code § 625.6; Welfare and Institutions Code § 625.7):

- (a) Information is necessary to protect life or property from an imminent threat.
 - 1. The questions are limited to what is reasonably necessary to obtain the information relating to the threat.

314.13.1 MANDATORY RECORDINGS OF JUVENILES

Any interrogation of an individual under 18 years of age who is in custody and suspected of committing murder shall be audio and video recorded when the interview takes place at a department facility, jail, detention facility, or other fixed place of detention. The recording shall include the entire interview and a *Miranda* advisement preceding the interrogation (Penal Code § 859.5).

This recording is not mandatory when (Penal Code § 859.5):

- (a) Recording is not feasible because of exigent circumstances that are later documented in a report.
- (b) The individual refuses to have the interrogation recorded, including a refusal any time during the interrogation, and the refusal is documented in a report. If feasible, the refusal shall be electronically recorded.
- (c) The custodial interrogation occurred in another state by law enforcement officers of that state, unless the interrogation was conducted with the intent to avoid the requirements of Penal Code § 859.5.
- (d) The interrogation occurs when no member conducting the interrogation has a reason to believe that the individual may have committed murder. Continued custodial interrogation concerning that offense shall be electronically recorded if the interrogating member develops a reason to believe the individual committed murder.
- (e) The interrogation would disclose the identity of a confidential informant or would jeopardize the safety of an officer, the individual being interrogated, or another individual. Such circumstances shall be documented in a report.

Culver City Police Department

Culver City PD Policy Manual

Temporary Custody of Juveniles

- (f) A recording device fails despite reasonable maintenance and the timely repair or replacement is not feasible.
- (g) The questions are part of a routine processing or booking, and are not an interrogation.
- (h) The suspect is in custody for murder and the interrogation is unrelated to a murder. However, if any information concerning a murder is mentioned during the interrogation, the remainder of the interrogation shall be recorded.

These recordings shall be retained until a conviction is final and all direct and habeas corpus appeals are exhausted, a court no longer has any jurisdiction over the individual, or the prosecution for that offense is barred (Penal Code § 859.5; Welfare and Institutions Code § 626.8).

314.14 FORMAL BOOKING

No juvenile offender shall be formally booked without the authorization of the arresting officer's supervisor, or in the supervisor's absence, the Watch Commander.

Any juvenile 14 years of age or older who is taken into custody for a felony, or any juvenile whose acts amount to a sex crime, shall be booked, fingerprinted, and photographed.

For all other acts defined as crimes, juveniles may be booked, fingerprinted, or photographed upon the approval from the Watch Commander or the Detective Bureau supervisor, giving due consideration to the following:

- (a) The gravity of the offense
- (b) The past record of the offender
- (c) The age of the offender

314.15 RELEASE OF INFORMATION CONCERNING JUVENILES

Court decisions and legislation have combined to carefully specify situations in which information may be given out or exchanged when a case involves a juvenile. Members of this department shall not divulge any information regarding juveniles unless they are certain of the legal authority to do so.

Welfare and Institutions Code § 828 authorizes the release of certain information to other agencies. It shall be the responsibility of the Records Supervisor and the appropriate Detective Bureau supervisors to ensure that personnel of those bureaus act within legal guidelines.

314.16 BOARD OF STATE AND COMMUNITY CORRECTIONS CERTIFICATION

The Operations Bureau Commander shall coordinate the procedures related to the custody of juveniles held at the Culver City Police Department and ensure any required certification is maintained (Welfare and Institution Code § 210.2).

314.17 RELIGIOUS ACCOMMODATION

Juveniles have the right to the same religious accommodation as adults in temporary custody (see the Temporary Custody of Adults Policy).

Culver City Police Department

Culver City PD Policy Manual

Temporary Custody of Juveniles

314.18 TRAINING

Department members should be trained on and familiar with this policy and any supplemental procedures.

Senior and Disability Victimization

315.1 PURPOSE AND SCOPE

The purpose of this policy is to provide guidelines for the investigation and reporting of suspected abuse of certain adults who may be more vulnerable than others. This policy also addresses mandatory notification for Culver City Police Department members as required by law (Penal Code § 368.6).

The Culver City Police Department is committed to providing equal protection and demonstrating respect for all persons regardless of age or disabilities, and to conscientiously enforcing all criminal laws protecting elders, and adults and children with disabilities, regardless of whether these crimes also carry civil penalties (Penal Code § 368.6) (see Child Abuse Policy for child abuse investigations and reporting).

315.1.1 DEFINITIONS

Definitions related to this policy include:

Abuse of an elder (age 65 or older) or dependent adult - Physical abuse, neglect, financial abuse, abandonment, isolation, abduction, or other treatment with resulting physical harm or pain or mental suffering; or the deprivation by a care custodian of goods or services that are necessary to avoid physical harm or mental suffering. Neglect includes self-neglect (Welfare and Institutions Code § 15610.05 et seq.; Penal Code § 368.5).

Department protocols (or protocols) - A procedure adopted by a local law enforcement agency consistent with the agency's organizational structure and stated in a policy adopted pursuant to this section, to effectively and accountably carry out a particular agency responsibility.

Dependent adult - An individual, regardless of whether the individual lives independently, between 18 and 64 years of age who has physical or mental limitations that restrict their ability to carry out normal activities or to protect their rights, including but not limited to persons who have physical or developmental disabilities or whose physical or mental abilities have diminished because of age. This also includes those admitted as inpatients to a 24-hour health facility, as defined in state law (Penal Code § 368; Welfare and Institutions Code § 15610.23).

Elder and dependent adult abuse - Any offense or attempted offense involving violence or neglect of an adult victim when committed by a person responsible for the adult's care, or any other act that would mandate reporting or notification to a social service agency or law enforcement (Penal Code § 368).

Senior and disability victimization - Means any of the following (Penal Code § 368.6):

- (a) Elder and dependent adult abuse
- (b) Unlawful interference with a mandated report
- (c) Homicide of an elder, dependent adult, or other adult or child with a disability

Culver City Police Department

Culver City PD Policy Manual

Senior and Disability Victimization

- (d) Sex crimes against elders, dependent adults, or other adults and children with disabilities
- (e) Child abuse of children with disabilities
- (f) Violation of relevant protective orders
- (g) Hate crimes against persons with actual or perceived disabilities, including but not limited to disabilities caused by advanced age, or those associated with them
- (h) Domestic violence against elders, dependent adults, and adults and children with disabilities, including disabilities caused by advanced age

315.2 POLICY

The Culver City Police Department will investigate all reported incidents of alleged elder and dependent adult abuse and ensure proper reporting and notification as required by law.

315.2.1 ARREST POLICY

It is the department policy to make arrests or to seek arrest warrants for elder and dependent adult abuse in accordance with Penal Code § 836 and, in the case of domestic violence, as allowed by Penal Code § 13701 (Penal Code § 368.6) (see Law Enforcement Authority and Domestic Violence policies for additional guidance).

315.2.2 ADHERENCE TO POLICY

All officers are required to be familiar with the policy and carry out the policy at all times, except in the case of an unusual compelling circumstance as determined and approved by a supervisor (Penal Code § 368.6).

Any supervisor who determines and approves an officer's deviation from this policy shall provide a written report to the Chief of Police that states the unusual compelling circumstances regarding the deviation. A copy of this report will be made available to the alleged victim and reporting party pursuant to department protocols (Penal Code § 368.6(c)(27)).

The Chief of Police shall retain the report for a minimum of five years and shall make it available to the state protection and advocacy agency upon request (Penal Code § 368.6(c)(27)).

315.3 INVESTIGATIONS AND REPORTING

All reported or suspected cases of elder and dependent adult abuse require investigation and a report, even if the allegations appear unfounded or unsubstantiated (Penal Code § 368.6).

Investigations and reports related to suspected cases of elder and dependent adult abuse should address, as applicable:

- (a) The overall basis for the contact. This should be done by the investigating officer in all circumstances where a suspected elder and dependent adult abuse victim is contacted.
- (b) Any relevant statements the victim may have made and to whom he/she made the statements.

Culver City Police Department

Culver City PD Policy Manual

Senior and Disability Victimization

- (c) If a person is taken into protective custody, the reasons, the name and title of the person making the decision, and why other alternatives were not appropriate.
- (d) Documentation of any visible injuries or any injuries identified by the victim. This should include photographs of such injuries, if practicable.
- (e) Whether the victim was transported for medical treatment or a medical examination.
- (f) Whether the victim identified a household member as the alleged perpetrator, and a list of the names of any other potential victims or witnesses who may reside in the residence.
- (g) Identification of any prior related reports or allegations of abuse, including other jurisdictions, as reasonably known.
- (h) Previous addresses of the victim and suspect.
- (i) Other potential witnesses who have not yet been interviewed, such as relatives or others close to the victim's environment.
- (j) Witness and suspect statements if available.
- (k) Review of all portable audio/video recorders, devices, and other available video.
- (l) Call history related to the elder or dependent adult including calls from mandated reporters or other individuals.
- (m) Whether the abuse is related to a disability-bias hate crime and related bias motivations (Penal Code § 368.6) (see the Hate Crimes Policy for additional guidance).
- (n) Results of investigations shall be provided to those agencies (Adult Protective Services (APS), long-term ombudsman) that referred or reported the elder or dependent adult abuse (Welfare and Institutions Code § 15640(f)).
- (o) Whether a death involved the End of Life Option Act:
 - 1. Whether or not assistance was provided to the person beyond that allowed by law (Health and Safety Code § 443.14).
 - 2. Whether an individual knowingly altered or forged a request for an aid-in-dying drug to end a person's life without his/her authorization, or concealed or destroyed a withdrawal or rescission of a request for an aid-in-dying drug (Health and Safety Code § 443.17).
 - 3. Whether coercion or undue influence was exerted on the person to request or ingest an aid-in-dying drug or to destroy a withdrawal or rescission of a request for such medication (Health and Safety Code § 443.17).
 - 4. Whether an aid-in-dying drug was administered to a person without his/her knowledge or consent (Health and Safety Code § 443.17).

Any unexplained death of an adult who was in the care of a guardian or caretaker should be considered as potential elder or dependent adult abuse and investigated similarly.

An unexplained or suspicious death of an elder, dependent adult, or other adult or child with a disability should be treated as a potential homicide until a complete investigation including an

Culver City Police Department

Culver City PD Policy Manual

Senior and Disability Victimization

autopsy is completed, and it should not be assumed that the death of an elder or person with a disability is natural simply because of the age or disability of the deceased (Penal Code § 368.6(c)(18)).

315.3.1 ADDITIONAL INVESTIGATIVE CONSIDERATIONS

The following factors as provided in Penal Code § 368.6 should be considered when investigating incidents of elder and dependent adult abuse:

- (a) Elder and dependent adult abuse, sex crimes, child abuse, domestic violence, and any other criminal act, when committed in whole or in part because of the victim's actual or perceived disability, including disability caused by advanced age, is also a hate crime (Penal Code § 368.6) (see the Hate Crimes Policy for additional guidance).
- (b) Senior and disability victimization crimes are also domestic violence subject to the mandatory arrest requirements of Penal Code § 836 if they meet the elements described in Penal Code § 273.5, including but not limited to a violation by a caretaker or other person who is or was a cohabitant of the victim, regardless of whether the cohabitant is or was a relative of, or in an intimate personal relationship with, the victim (Penal Code § 368.6(c)(10)).
- (c) Many victims of sexual assault and other sex crimes delay disclosing the crimes for reasons including but not limited to shame, embarrassment, self-doubt, fear of being disbelieved, and fear of retaliation by the perpetrator or others (Penal Code § 368.6(c)(11)).
- (d) Victims and witnesses with disabilities, including cognitive and communication disabilities, can be highly credible witnesses when interviewed appropriately by trained officers or other trained persons (Penal Code § 368.6(c)(14)).

315.4 QUALIFIED INVESTIGATORS

Qualified investigators should be available to investigate cases of elder and dependent adult abuse. These investigators should:

- (a) Conduct interviews in appropriate interview facilities.
- (b) Be familiar with forensic interview techniques specific to elder and dependent adult abuse investigations.
- (c) Present all cases of alleged elder and dependent adult abuse to the prosecutor for review.
- (d) Coordinate with other enforcement agencies, social service agencies, and facility administrators as needed (Welfare and Institutions Code § 15650).
- (e) Provide referrals to therapy services, victim advocates, guardians, and support for the victim and family as appropriate (see the Victim and Witness Assistance Policy for additional guidance).
 - 1. Ensure victims of sex crimes know their right to have a support person of their choice present at all times during an interview or contact (Penal Code § 368.6) (see the Sexual Assault Investigations Policy for additional guidance).

Culver City Police Department

Culver City PD Policy Manual

Senior and Disability Victimization

2. Referrals to the crime victim liaison as appropriate for victims requiring further assistance or information regarding benefits from crime victim resources.
- (f) Participate in or coordinate with multidisciplinary investigative teams as applicable (Welfare and Institutions Code § 15610.55).
- (g) Make reasonable efforts to determine whether any person committed unlawful interference in a mandated report.

315.5 MANDATORY NOTIFICATION

Members of the Culver City Police Department shall notify the local office of the California Department of Social Services (CDSS) APS agency of known, suspected, or alleged instances of abuse when they reasonably suspect, have observed, or have knowledge of an incident that reasonably appears to be abuse of an elder or dependent adult, or are told by an elder or dependent adult that the person has experienced abuse (Welfare and Institutions Code § 15630(b)).

Notification shall be made by telephone or through a confidential internet reporting tool as soon as practicable. If notification is made by telephone, a written report shall be sent or internet report shall be made through the confidential internet reporting tool within two working days, as provided in Welfare and Institutions Code § 15630(b).

Notification shall also be made to the following agencies as soon as practicable or as provided below (Welfare and Institutions Code § 15630):

- (a) If the abuse occurred in a long-term care facility (not a state mental health hospital or a state developmental center), notification shall be made as follows (Welfare and Institutions Code § 15630(b)(1)):
 1. If there is serious bodily injury, notification shall be made by telephone and, within two hours, a written report shall be made to the local ombudsman and the corresponding licensing agency.
 2. If the abuse is allegedly caused by a resident with dementia and there is no serious bodily injury, notification shall be made by a written report to the local ombudsman within 24 hours.
 3. If there is any other abuse in a long-term care facility (not a state mental health or a state developmental center), a written report shall be made to the local ombudsman and corresponding state licensing agency within 24 hours.
- (b) The California Department of Public Health (DPH) shall be notified of all known or suspected abuse in a long-term care facility.
- (c) The CDSS shall be notified of all known or suspected abuse occurring in a residential care facility for the elderly or in an adult day program.
- (d) If the abuse occurred in an adult day health care center, DPH and the California Department of Aging shall be notified.
- (e) The Division of Medi-Cal Fraud and Elder Abuse shall be notified of all abuse that constitutes criminal activity in a long-term care facility.

Culver City Police Department

Culver City PD Policy Manual

Senior and Disability Victimization

- (f) The District Attorney's office shall be notified of all cases of physical abuse and financial abuse in a long-term care facility.
- (g) If the abuse occurred at a state mental hospital or a state developmental center, notification shall be made to the designated investigators of the California Department of State Hospitals or the California Department of Developmental Services as soon as practicable but no later than two hours after law enforcement becomes aware of the abuse (Welfare and Institutions Code § 15630(b)).
 - 1. When a report of abuse is received by the Department, investigation efforts shall be coordinated with the designated investigators of the California Department of State Hospitals or the California Department of Developmental Services (Welfare and Institutions Code § 15630(b)).
- (h) If during an investigation it is determined that the elder or dependent adult abuse is being committed by a licensed health practitioner as identified in Welfare and Institutions Code § 15640(b), the appropriate licensing agency shall be immediately notified (Welfare and Institutions Code 15640(b)).
- (i) When the Department receives a report of abuse, neglect, or abandonment of an elder or dependent adult alleged to have occurred in a long-term care facility, the licensing agency shall be notified by telephone as soon as practicable (Welfare and Institutions Code § 15640(e)).

The Detective Bureau supervisor is responsible for ensuring that proper notifications have occurred to the District Attorney's Office and any other regulatory agency that may be applicable based upon where the abuse took place (e.g., care facility, hospital) per Welfare and Institutions Code § 15630(b).

Notification is not required for a person who was merely present when a person self-administered a prescribed aid-in-dying drug or a person prepared an aid-in-dying drug so long as the person did not assist the individual in ingesting the aid-in-dying drug (Health and Safety Code § 443.14; Health and Safety Code § 443.18).

Failure to report or impeding or inhibiting a report of abuse of an elder or dependent adult is a misdemeanor (Welfare and Institutions Code §15630(h)).

315.5.1 NOTIFICATION PROCEDURE

Notification should include the following information, if known (Welfare and Institutions Code § 15630(e)):

- (a) The name of the person making the report.
- (b) The name and age of the elder or dependent adult.
- (c) The present location of the elder or dependent adult.
- (d) The names and addresses of family members or any other adult responsible for the care of the elder or dependent adult.
- (e) The nature and extent of the condition of the elder or dependent adult.
- (f) The date of incident.

Culver City Police Department

Culver City PD Policy Manual

Senior and Disability Victimization

- (g) Any other information, including information that led the person to suspect elder or dependent adult abuse.

315.6 PROTECTIVE CUSTODY

Before taking an elder or dependent adult abuse victim into protective custody when facts indicate the adult may not be able to care for him/herself, the officer should make reasonable attempts to contact APS. Generally, removal of an adult abuse victim from his/her family, guardian, or other responsible adult should be left to the welfare authorities when they are present or have become involved in an investigation.

Generally, members of this department should remove an elder or dependent adult abuse victim from his/her family or guardian without a court order only when no other effective alternative is reasonably available and immediate action reasonably appears necessary to protect the victim. Prior to taking an elder or dependent adult abuse victim into protective custody, the officer should take reasonable steps to deliver the adult to another qualified legal guardian, unless it reasonably appears that the release would endanger the victim or result in abduction. If this is not a reasonable option, the officer shall ensure that the adult is delivered to APS.

Whenever practicable, the officer should inform a supervisor of the circumstances prior to taking an elder or dependent adult abuse victim into protective custody. If prior notification is not practicable, officers should contact a supervisor promptly after taking the adult into protective custody.

When elder or dependent adult abuse victims are under state control, have a state-appointed guardian, or there are other legal holdings for guardianship, it may be necessary or reasonable to seek a court order on behalf of the adult victim to either remove the adult from a dangerous environment (protective custody) or restrain a person from contact with the adult.

315.6.1 EMERGENCY PROTECTIVE ORDERS

In any situation which an officer reasonably believes that an elder or dependent adult is in immediate and present danger of abuse based on an allegation of a recent incident of abuse or threat of abuse (other than financial abuse alone), the officer may seek an emergency protective order against the person alleged to have committed or threatened such abuse (Family Code § 6250(d)).

315.6.2 VERIFICATION OF PROTECTIVE ORDER

Whenever an officer verifies that a relevant protective order has been issued, the officer shall make reasonable efforts to determine if the order prohibits the person from possession of firearms or requires the relinquishment of firearms, and if the order does so, the officer shall make reasonable efforts to (Penal Code § 368.6(c)(19)):

- (a) Inquire whether the restrained person possesses firearms. The officer should make this effort by asking the restrained person and the protected person.
- (b) Query the California Law Enforcement Telecommunications System to determine if any firearms are registered to the restrained person.

Culver City Police Department

Culver City PD Policy Manual

Senior and Disability Victimization

- (c) Receive or seize prohibited firearms located in plain view or pursuant to a consensual or other lawful search in compliance with Penal Code § 18250 et seq. and in accordance with department procedures.

315.7 INTERVIEWS

315.7.1 PRELIMINARY INTERVIEWS

Absent extenuating circumstances or impracticality, officers should audio record the preliminary interview with a suspected elder or dependent adult abuse victim. Officers should avoid multiple interviews with the victim and should attempt to gather only the information necessary to begin an investigation. When practicable, investigating officers should defer interviews until a person who is specially trained in such interviews is available.

315.7.2 DETAINING VICTIMS FOR INTERVIEWS

An officer should not detain an adult involuntarily who is suspected of being a victim of abuse solely for the purpose of an interview or physical exam without his/her consent or the consent of a guardian unless one of the following applies:

- (a) Exigent circumstances exist, such as:
 1. A reasonable belief that medical issues of the adult need to be addressed immediately.
 2. A reasonable belief that the adult is or will be in danger of harm if the interview or physical exam is not immediately completed.
 3. The alleged offender is a family member or guardian and there is reason to believe the adult may be in continued danger.
- (b) A court order or warrant has been issued.

315.7.3 INTERVIEWS WITH A PERSON WITH DEAFNESS OR HEARING LOSS

An officer who is interviewing a victim or witness who reports or demonstrates deafness or hearing loss should secure the services of a qualified interpreter (as defined by Evidence Code § 754) prior to the start of the interview (Penal Code § 368.6) (see the Communications with Persons with Disabilities Policy for additional guidance).

315.8 MEDICAL EXAMINATIONS

When an elder or dependent adult abuse investigation requires a medical examination, the investigating officer should obtain consent for such examination from the victim, guardian, agency, or entity having legal custody of the adult. The officer should also arrange for the adult's transportation to the appropriate medical facility.

In cases where the alleged offender is a family member, guardian, agency, or entity having legal custody and is refusing to give consent for the medical examination, officers should notify a supervisor before proceeding. If exigent circumstances do not exist or if state law does not provide for officers to take the adult for a medical examination, the supervisor should consider other government agencies or services that may obtain a court order for such an examination.

Culver City Police Department

Culver City PD Policy Manual

Senior and Disability Victimization

315.9 DRUG-ENDANGERED VICTIMS

A coordinated response by law enforcement and social services agencies is appropriate to meet the immediate and longer-term medical and safety needs of an elder or dependent adult abuse victim who has been exposed to the manufacturing, trafficking, or use of narcotics.

315.9.1 OFFICER RESPONSIBILITIES

Officers responding to a drug lab or other narcotics crime scene where an elder or dependent adult abuse victim is present or where there is evidence that an elder or dependent adult abuse victim lives should:

- (a) Document the environmental, medical, social, and other conditions of the adult, using photography as appropriate and the checklist or form developed for this purpose.
- (b) Notify the Detective Bureau supervisor so an interagency response can begin.

315.9.2 SUPERVISOR RESPONSIBILITIES

The Detective Bureau supervisor should:

- (a) Work with professionals from the appropriate agencies, including APS, other law enforcement agencies, medical service providers, and local prosecutors, to develop community specific procedures for responding to situations where there are elder or dependent adult abuse victims endangered by exposure to methamphetamine labs or the manufacture and trafficking of other drugs.
- (b) Activate any available interagency response when an officer notifies the Detective Bureau supervisor that he/she has responded to a drug lab or other narcotics crime scene where an elder or dependent adult abuse victim is present or where evidence indicates that an elder or dependent adult abuse victim lives.
- (c) Develop a report format or checklist for use when officers respond to drug labs or other narcotics crime scenes. The checklist will help officers document the environmental, medical, social, and other conditions that may affect the adult.

315.10 TRAINING

The Department should provide training on best practices in elder and dependent adult abuse investigations to members tasked with investigating these cases. The training should include:

- (a) Participating in multidisciplinary investigations, as appropriate.
- (b) Conducting interviews.
- (c) Availability of therapy services for adults and families.
- (d) Availability of specialized forensic medical exams.
- (e) Cultural competence (including interpretive services) related to elder and dependent adult abuse investigations.
- (f) Availability of victim advocates or other support.

Culver City Police Department

Culver City PD Policy Manual

Senior and Disability Victimization

315.10.1 MANDATORY TRAINING

The Personnel and Training Lieutenant shall ensure that appropriate personnel receive the required training, including:

- (a) Materials from POST as described in Penal Code § 368.6(c)(5)(A).
- (b) Advanced training on senior and disability victimization available from POST, the United States Department of Justice, the Disability and Abuse Project of the Spectrum Institute, or other sources as provided by Penal Code § 368.6(c)(16)(A).
 1. Training should include the following:
 - (a) Information on the wide prevalence of elder and dependent adult abuse, sexual assault, other sex crimes, hate crimes, domestic violence, human trafficking, and homicide against adults and children with disabilities, including disabilities caused by advanced age, and including those crimes often committed by caretakers (Penal Code § 368.6(c)(1)).
 - (b) Information on the history of elder and dependent adult abuse and crimes against individuals with disabilities (see the POST Senior and Disability Victimization Policy Guidelines).

The Personnel and Training Lieutenant shall also ensure that appropriate training is provided on this policy to dispatchers, community services officers, front desk personnel, and other civilian personnel who interact with the public (Penal Code § 368.6 (c)(7)).

315.11 RECORDS BUREAU RESPONSIBILITIES

The Records Section is responsible for:

- (a) Providing a copy of the elder or dependent adult abuse report to the APS, ombudsman, or other agency as applicable within two working days or as required by law (Welfare and Institutions Code § 15630; Welfare and Institutions Code § 15640(c)).
- (b) Retaining the original elder or dependent adult abuse report with the initial case file.

315.12 JURISDICTION

The Culver City Police Department has concurrent jurisdiction with state law enforcement agencies when investigating elder and dependent adult abuse and all other crimes against elder victims and victims with disabilities (Penal Code § 368.5).

Adult protective services agencies and local long-term care ombudsman programs also have jurisdiction within their statutory authority to investigate elder and dependent adult abuse and criminal neglect and may assist in criminal investigations upon request, if consistent with federal law, in such cases. However, this department will retain responsibility for the criminal investigations (Penal Code § 368.5).

Additional jurisdiction responsibilities for investigations of abuse involving various facilities and agencies may be found in Welfare and Institutions Code § 15650.

315.13 RELEVANT STATUTES

Penal Code § 288 (a) and Penal Code § 288 (b)(2)

Culver City Police Department

Culver City PD Policy Manual

Senior and Disability Victimization

(a) Except as provided in subdivision (i), a person who willfully and lewdly commits any lewd or lascivious act, including any of the acts constituting other crimes provided for in Part 1 (Of Crimes and Punishments of the Penal Code) upon or with the body, or any part or member thereof, of a child who is under the age of 14 years, with the intent of arousing, appealing to, or gratifying the lust, passions, or sexual desires of that person or the child, is guilty of a felony and shall be punished by imprisonment in the state prison for three, six, or eight years.

(b)(2) A person who is a caretaker and commits an act described in subdivision (a) upon a dependent person by use of force, violence, duress, menace, or fear of immediate and unlawful bodily injury on the victim or another person, with the intent described in subdivision (a), is guilty of a felony and shall be punished by imprisonment in the state prison for 5, 8, or 10 years.

Penal Code § 368 (c)

A person who knows or reasonably should know that a person is an elder or dependent adult and who, under circumstances or conditions other than those likely to produce great bodily harm or death, willfully causes or permits any elder or dependent adult to suffer, or inflicts thereon unjustifiable physical pain or mental suffering, or having the care or custody of any elder or dependent adult, willfully causes or permits the person or health of the elder or dependent adult to be injured or willfully causes or permits the elder or dependent adult to be placed in a situation in which their person or health may be endangered, is guilty of a misdemeanor.

Penal Code § 368 (f)

A person who commits the false imprisonment of an elder or a dependent adult by the use of violence, menace, fraud, or deceit is punishable by imprisonment pursuant to subdivision (h) of Section 1170 for two, three, or four years.

Protections provided by the above Penal Code § 288 and Penal Code § 368 protect many persons with disabilities regardless of the fact they live independently.

Welfare and Institutions Code § 15610.05

"Abandonment" means the desertion or willful forsaking of an elder or a dependent adult by anyone having care or custody of that person under circumstances in which a reasonable person would continue to provide care and custody.

Welfare and Institutions Code § 15610.06

"Abduction" means the removal from this state and the restraint from returning to this state, or the restraint from returning to this state, of any elder or dependent adult who does not have the capacity to consent to the removal from this state and the restraint from returning to this state, or the restraint from returning to this state, as well as the removal from this state or the restraint from returning to this state, of any conservatee without the consent of the conservator or the court.

Welfare and Institutions Code § 15610.30

- (a) "Financial abuse" of an elder or dependent adult occurs when a person or entity does any of the following:

Culver City Police Department

Culver City PD Policy Manual

Senior and Disability Victimization

1. Takes, secretes, appropriates, obtains, or retains real or personal property of an elder or dependent adult for a wrongful use or with intent to defraud, or both.
 2. Assists in taking, secreting, appropriating, obtaining, or retaining real or personal property of an elder or dependent adult for a wrongful use or with intent to defraud, or both.
 3. Takes, secretes, appropriates, obtains, or retains, or assists in taking, secreting, appropriating, obtaining, or retaining, real or personal property of an elder or dependent adult by undue influence, as defined in Section 15610.70.
- (b) A person or entity shall be deemed to have taken, secreted, appropriated, obtained, or retained property for a wrongful use if, among other things, the person or entity takes, secretes, appropriates, obtains, or retains the property and the person or entity knew or should have known that this conduct is likely to be harmful to the elder or dependent adult.
- (c) For purposes of this section, a person or entity takes, secretes, appropriates, obtains, or retains real or personal property when an elder or dependent adult is deprived of any property right, including by means of an agreement, donative transfer, or testamentary bequest, regardless of whether the property is held directly or by a representative of an elder or dependent adult.
- (d) For purposes of this section, "representative" means a person or entity that is either of the following:
1. A conservator, trustee, or other representative of the estate of an elder or dependent adult.
 2. An attorney-in-fact of an elder or dependent adult who acts within the authority of the power of attorney.

Welfare and Institutions Code § 15610.43

- (a) "Isolation" means any of the following:
1. Acts intentionally committed for the purpose of preventing, and that do serve to prevent, an elder or dependent adult from receiving his or her mail or telephone calls.
 2. Telling a caller or prospective visitor that an elder or dependent adult is not present, or does not wish to talk with the caller, or does not wish to meet with the visitor where the statement is false, is contrary to the express wishes of the elder or the dependent adult, whether he or she is competent or not, and is made for the purpose of preventing the elder or dependent adult from having contact with family, friends, or concerned persons.
 3. False imprisonment, as defined in Section 236 of the Penal Code.
 4. Physical restraint of an elder or dependent adult, for the purpose of preventing the elder or dependent adult from meeting with visitors.
- (b) The acts set forth in subdivision (a) shall be subject to a rebuttable presumption that they do not constitute isolation if they are performed pursuant to the instructions of a

Culver City Police Department

Culver City PD Policy Manual

Senior and Disability Victimization

physician and surgeon licensed to practice medicine in the state, who is caring for the elder or dependent adult at the time the instructions are given, and who gives the instructions as part of his or her medical care.

- (c) The acts set forth in subdivision (a) shall not constitute isolation if they are performed in response to a reasonably perceived threat of danger to property or physical safe.

Welfare and Institutions Code § 15610.57

- (a) "Neglect" means either of the following:
 1. The negligent failure of any person having the care or custody of an elder or a dependent adult to exercise that degree of care that a reasonable person in a like position would exercise.
 2. The negligent failure of an elder or dependent adult to exercise that degree of self care that a reasonable person in a like position would exercise.
- (b) Neglect includes, but is not limited to, all of the following:
 1. Failure to assist in personal hygiene, or in the provision of food, clothing, or shelter.
 2. Failure to provide medical care for physical and mental health needs. A person shall not be deemed neglected or abused for the sole reason that the person voluntarily relies on treatment by spiritual means through prayer alone in lieu of medical treatment.
 3. Failure to protect from health and safety hazards.
 4. Failure to prevent malnutrition or dehydration.
 5. Substantial inability or failure of an elder or dependent adult to manage personal finances.
 6. Failure of an elder or dependent adult to satisfy any of the needs specified in paragraphs (1) to (5), inclusive, for themselves as a result of poor cognitive functioning, mental limitation, substance abuse, or chronic poor health.
- (c) Neglect includes being homeless if the elder or dependent adult is also unable to meet any of the needs specified in paragraphs (1) to (5), inclusive, of subdivision (b).

Welfare and Institutions Code § 15610.63

"Physical abuse" means any of the following:

- (a) Assault, as defined in Section 240 of the Penal Code.
- (b) Battery, as defined in Section 242 of the Penal Code.
- (c) Assault with a deadly weapon or force likely to produce great bodily injury, as defined in Section 245 of the Penal Code.
- (d) Unreasonable physical constraint, or prolonged or continual deprivation of food or water.
- (e) Sexual assault, that means any of the following:

Culver City Police Department

Culver City PD Policy Manual

Senior and Disability Victimization

1. Sexual battery, as defined in Section 243.4 of the Penal Code.
 2. Rape, as defined in Section 261 of the Penal Code, or former Section 262 of the Penal Code.
 3. Rape in concert, as described in Section 264.1 of the Penal Code.
 4. Incest, as defined in Section 285 of the Penal Code.
 5. Sodomy, as defined in Section 286 of the Penal Code.
 6. Oral copulation, as defined in Section 287 or former Section 288a of the Penal Code.
 7. Sexual penetration, as defined in Section 289 of the Penal Code.
 8. Lewd or lascivious acts as defined in paragraph (2) of subdivision (b) of Section 288 of the Penal Code.
- (f) Use of a physical or chemical restraint or psychotropic medication under any of the following conditions:
1. For punishment.
 2. For a period beyond that for which the medication was ordered pursuant to the instructions of a physician and surgeon licensed in the State of California, who is providing medical care to the elder or dependent adult at the time the instructions are given.
 3. For any purpose not authorized by the physician and surgeon.

315.14 CHIEF OF POLICE RESPONSIBILITIES

The Chief of Police or the authorized designee responsibilities include but are not limited to (Penal Code § 368.6):

- (a) Taking leadership within the Department and in the community, including by speaking out publicly in major cases of senior and disability victimization, to assure the community of department support for the victims and their families and for others in the community who are terrorized and traumatized by the crimes, and to encourage victims and witnesses to the crimes or similar past or future crimes to report those crimes to help bring the perpetrators to justice and prevent further crimes.
- (b) Developing and including department protocols in this policy, including but not limited to the following:
 1. Protocols for seeking emergency protective orders by phone from a court at any time of day or night pursuant to Family Code § 6250(d).
 2. Protocols for arrest warrants and arrests for senior and disability victimization for matters other than domestic violence and consistent with the requirements of Penal Code § 368.6(c)(9)(B) that include the following:
 - (a) In the case of a senior and disability victimization committed in an officer's presence, including but not limited to a violation of a relevant protective

Culver City Police Department

Culver City PD Policy Manual

Senior and Disability Victimization

order, the officer shall make a warrantless arrest based on probable cause when necessary or advisable to protect the safety of the victim or others.

- (b) In the case of a felony not committed in an officer's presence, the officer shall make a warrantless arrest based on probable cause when necessary or advisable to protect the safety of the victim or others.
 - (c) In the case of a misdemeanor not committed in the officer's presence, including but not limited to misdemeanor unlawful interference with a mandated report or a misdemeanor violation of a relevant protective order, or when necessary or advisable to protect the safety of the victim or others, the agency shall seek an arrest warrant based on probable cause.
 - (d) Protocol for seeking arrest warrants based on probable cause for crimes for which no arrest has been made.
3. Procedures for first responding officers to follow when interviewing persons with cognitive and communication disabilities until officers, or staff of other responsible agencies with more advanced training, are available. The procedure shall include an instruction to avoid repeated interviews whenever possible.
- (c) For each department protocol, include either a specific title-by-title list of officer responsibilities or a specific office or unit in the Department responsible for implementing the protocol.
 - (d) Ensuring an appendix is created and attached to this policy that describes requirements for elder and dependent adult abuse investigations consistent with Penal Code § 368.6(c)(8)(B).
 - (e) Ensuring a detailed checklist is created and attached to this policy regarding first responding responsibilities that includes but is not limited to the requirements of Penal Code § 368.6(c)(23).
 - (f) Ensuring that all members carry out their responsibilities under this policy.
 - (g) Verifying a process is in place for transmitting and periodically retransmitting this policy and related orders to officers, including a simple and immediate way for officers to access the policy in the field when needed.
 - (h) Ensuring this policy is available to the Protection and Advocacy Agency upon request.

315.15 ELDER AND DEPENDENT ADULT ABUSE LIAISON

A department member appointed by the Chief of Police or the authorized designee will serve as the Elder and Dependent Adult Abuse Liaison. Responsibilities of the liaison include but are not limited to (Penal Code § 368.6):

- (a) Acting as a liaison to other responsible agencies (defined by Penal Code § 368.6(b)(15)) to increase cooperation and collaboration among them while retaining the law enforcement agency's exclusive responsibility for criminal investigations (Welfare and Institutions Code § 15650).
- (b) Reaching out to the senior and disability communities and to the public to encourage prevention and reporting of senior and disability victimization.

Discriminatory Harassment

316.1 PURPOSE AND SCOPE

The purpose of this policy is to prevent department members from being subjected to discriminatory harassment, including sexual harassment and retaliation. Nothing in this policy is intended to create a legal or employment right or duty that is not created by law.

316.2 POLICY

The Culver City Police Department is an equal opportunity employer and is committed to creating and maintaining a work environment that is free of all forms of discriminatory harassment, including sexual harassment and retaliation (Government Code § 12940(k); 2 CCR 11023). The Department will not tolerate discrimination against a member in hiring, promotion, discharge, compensation, fringe benefits and other privileges of employment. The Department will take preventive and corrective action to address any behavior that violates this policy or the rights it is designed to protect.

The nondiscrimination policies of the Department may be more comprehensive than state or federal law. Conduct that violates this policy may not violate state or federal law but still could subject a member to discipline.

316.3 DEFINITIONS

Definitions related to this policy include:

316.3.1 DISCRIMINATION

The Department prohibits all forms of discrimination, including any employment-related action by a member that adversely affects an applicant or member and is based on actual or perceived race, ethnicity, national origin, religion, sex, sexual orientation, gender identity or expression, age, disability, pregnancy, genetic information, veteran status, marital status, and any other classification or status protected by law.

Discriminatory harassment, including sexual harassment, is verbal or physical conduct that demeans or shows hostility or aversion toward an individual based upon that individual's protected class. It has the effect of interfering with an individual's work performance or creating a hostile or abusive work environment.

Conduct that may, under certain circumstances, constitute discriminatory harassment can include making derogatory comments; making crude and offensive statements or remarks; making slurs or off-color jokes, stereotyping; engaging in threatening acts; making indecent gestures, pictures, cartoons, posters, or material; making inappropriate physical contact; or using written material or department equipment and/or systems to transmit or receive offensive material, statements, or pictures. Such conduct is contrary to department policy and to a work environment that is free of discrimination.

Culver City Police Department

Culver City PD Policy Manual

Discriminatory Harassment

316.3.2 SEXUAL HARASSMENT

The Department prohibits all forms of discrimination and discriminatory harassment, including sexual harassment. It is unlawful to harass an applicant or a member because of that person's sex.

Sexual harassment includes but is not limited to unwelcome sexual advances, requests for sexual favors, or other verbal, visual, or physical conduct of a sexual nature when:

- (a) Submission to such conduct is made either explicitly or implicitly a term or condition of employment, position, or compensation.
- (b) Submission to, or rejection of, such conduct is used as the basis for any employment decisions affecting the member.
- (c) Such conduct has the purpose or effect of substantially interfering with a member's work performance or creating an intimidating, hostile, or offensive work environment.

316.3.3 ADDITIONAL CONSIDERATIONS

Discrimination and discriminatory harassment do not include actions that are in accordance with established rules, principles, or standards, including:

- (a) Acts or omission of acts based solely upon bona fide occupational qualifications under the Equal Employment Opportunity Commission (EEOC) and the California Civil Rights Council guidelines.
- (b) Bona fide requests or demands by a supervisor that the member improve the member's work quality or output, that the member report to the job site on time, that the member comply with City or department rules or regulations, or any other appropriate work-related communication between supervisor and member.

316.3.4 RETALIATION

Retaliation is treating a person differently or engaging in acts of reprisal or intimidation against the person because the person has engaged in protected activity, filed a charge of discrimination, participated in an investigation, or opposed a discriminatory practice. Retaliation will not be tolerated.

316.4 RESPONSIBILITIES

This policy applies to all department personnel. All members shall follow the intent of these guidelines in a manner that reflects department policy, professional standards, and the best interest of the Department and its mission.

Members are encouraged to promptly report any discriminatory, retaliatory, or harassing conduct or known violations of this policy to a supervisor. Any member who is not comfortable with reporting violations of this policy to the member's immediate supervisor may bypass the chain of command and make the report to a higher-ranking supervisor or manager. Complaints may also be filed with the Chief of Police, the Professional Standards Unit, or the City Council.

Any member who believes, in good faith, that the member has been discriminated against, harassed, or subjected to retaliation, or who has observed harassment, discrimination, or

Culver City Police Department

Culver City PD Policy Manual

Discriminatory Harassment

retaliation, is encouraged to promptly report such conduct in accordance with the procedures set forth in this policy.

Supervisors and managers receiving information regarding alleged violations of this policy shall determine if there is any basis for the allegation and shall proceed with resolution as stated below.

316.4.1 SUPERVISOR RESPONSIBILITIES

The responsibilities of supervisors and managers shall include but are not limited to:

- (a) Continually monitoring the work environment and striving to ensure that it is free from all types of unlawful discrimination, including harassment or retaliation.
- (b) Taking prompt, appropriate action within their work units to avoid and minimize the incidence of any form of discrimination, harassment, or retaliation.
- (c) Ensuring that their subordinates understand their responsibilities under this policy.
- (d) Ensuring that members who make complaints or who oppose any unlawful employment practices are protected from retaliation and that such matters are kept confidential to the extent possible.
- (e) Making a timely determination regarding the substance of any allegation based upon all available facts.
- (f) Notifying the Chief of Police or the Professional Standards Unit in writing of the circumstances surrounding any reported allegations or observed acts of discrimination, harassment, or retaliation no later than the next business day.

316.4.2 SUPERVISOR'S ROLE

Supervisors and managers shall be aware of the following:

- (a) Behavior of supervisors and managers should represent the values of the Department and professional standards.
- (b) False or mistaken accusations of discrimination, harassment, or retaliation can have negative effects on the careers of innocent members.

Nothing in this section shall be construed to prevent supervisors or managers from discharging supervisory or management responsibilities, such as determining duty assignments, evaluating or counseling members, or issuing discipline, in a manner that is consistent with established procedures.

316.4.3 QUESTIONS OR CLARIFICATION

Members with questions regarding what constitutes discrimination, sexual harassment, or retaliation are encouraged to contact a supervisor, a manager, the Chief of Police, the Personnel and Training Lieutenant, the City Council, or the California Civil Rights Department for further information, direction, or clarification (Government Code § 12950).

316.5 INVESTIGATION OF COMPLAINTS

Various methods of resolution exist. During the pendency of any such investigation, the supervisor of the involved member should take prompt and reasonable steps to mitigate or eliminate

Culver City Police Department

Culver City PD Policy Manual

Discriminatory Harassment

any continuing abusive or hostile work environment. It is the policy of the Department that all complaints of discrimination, retaliation, or harassment shall be fully documented and promptly and thoroughly investigated.

316.5.1 FORMAL INVESTIGATION

If the complaint cannot be satisfactorily resolved through the supervisory resolution process, a formal investigation will be conducted.

The person assigned to investigate the complaint will have full authority to investigate all aspects of the complaint. Investigative authority includes access to records and the cooperation of any members involved. No influence will be used to suppress any complaint and no member will be subject to retaliation or reprisal for filing a complaint, encouraging others to file a complaint, or for offering testimony or evidence in an investigation.

Formal investigation of the complaint will be confidential to the extent possible and will include but is not limited to details of the specific incident, frequency and dates of occurrences, and names of any witnesses. Witnesses will be advised regarding the prohibition against retaliation, and that a disciplinary process, up to and including termination, may result if retaliation occurs.

Members who believe they have been discriminated against, harassed, or retaliated against because of their protected status, are encouraged to follow the chain of command but may also file a complaint directly with the Chief of Police, the Professional Standards Unit, or the City Council.

316.5.2 ALTERNATIVE COMPLAINT PROCESS

No provision of this policy shall be construed to prevent any member from seeking legal redress outside the Department. Members who believe that they have been harassed, discriminated against, or retaliated against are entitled to bring complaints of employment discrimination to federal, state, and/or local agencies responsible for investigating such allegations. Specific time limitations apply to the filing of such charges. Members are advised that proceeding with complaints under the provisions of this policy does not in any way affect those filing requirements.

316.6 DOCUMENTATION OF COMPLAINTS

All complaints or allegations shall be thoroughly documented on forms and in a manner designated by the Chief of Police. The outcome of all reports shall be:

- (a) Approved by the Chief of Police, the City Council, or the Personnel and Training Lieutenant, depending on the ranks of the involved parties.
- (b) Maintained in accordance with the department's established records retention schedule.

316.6.1 NOTIFICATION OF DISPOSITION

The complainant and/or victim will be notified in writing of the disposition of the investigation and the actions taken to remedy or address the circumstances giving rise to the complaint.

Culver City Police Department

Culver City PD Policy Manual

Discriminatory Harassment

316.7 TRAINING

All new members shall be provided with a copy of this policy as part of their orientation. The policy shall be reviewed with each new member. The member shall certify by signing the prescribed form that the member has been advised of this policy, is aware of and understands its contents, and agrees to abide by its provisions during the member's term with the Department.

All members shall receive annual training on the requirements of this policy and shall certify by signing the prescribed form that they have reviewed the policy, understand its contents, and agree that they will continue to abide by its provisions.

316.7.1 STATE-REQUIRED TRAINING

The Personnel and Training Lieutenant should ensure that employees receive the required state training and education regarding sexual harassment, prevention of abusive conduct, and harassment based on gender identity, gender expression, and sexual orientation as follows (Government Code § 12950.1; 2 CCR 11024):

- (a) Supervisory employees shall receive two hours of classroom or other effective interactive training and education within six months of assuming a supervisory position.
- (b) All other employees shall receive one hour of classroom or other effective interactive training and education within six months of their employment or sooner for seasonal or temporary employees as described in Government Code § 12950.1.
- (c) All employees shall receive refresher training every two years thereafter.

If the required training is to be provided by the Civil Rights Department online training courses, the Personnel and Training Lieutenant should ensure that employees are provided the following website address to the training course: <https://calcivilrights.ca.gov> (Government Code § 12950; 2 CCR 11023).

316.7.2 TRAINING RECORDS

The Personnel and Training Lieutenant shall be responsible for maintaining records of all discriminatory harassment training provided to members. Records shall be retained in accordance with established records retention schedules and for a minimum of two years (2 CCR 11024).

316.8 WORKING CONDITIONS

The Administration Bureau Bureau Commander or the authorized designee should be responsible for reviewing facility design and working conditions for discriminatory practices. This person should collaborate with other City employees who are similarly tasked (2 CCR 11034).

316.9 REQUIRED POSTERS

The Department shall display the required posters regarding discrimination, harassment and transgender rights in a prominent and accessible location for members (Government Code § 12950).

Child Abuse

317.1 PURPOSE AND SCOPE

The purpose of this policy is to provide guidelines for the investigation of suspected child abuse. This policy also addresses when Culver City Police Department members are required to notify the county Child Protective Services (CPS) of suspected child abuse.

317.1.1 DEFINITIONS

Definitions related to this policy include:

Child - Unless otherwise specified by a cited statute, a child is any person under the age of 18 years.

Child abuse - Any offense or attempted offense involving violence or neglect with a child victim when committed by a person responsible for the child's care or any other act that would mandate notification to a social service agency or law enforcement (Penal Code § 11165.9; Penal Code § 11166).

317.2 POLICY

The Culver City Police Department will investigate all reported incidents of alleged criminal child abuse and ensure CPS is notified as required by law.

317.3 MANDATORY NOTIFICATION

The child protection agency shall be notified when (Penal Code § 11166):

- (a) There is a known or suspected instance of child abuse or neglect reported, which is alleged to have occurred as a result of the action of a person responsible for the child's welfare, or
- (b) A person responsible for the child's welfare fails to adequately protect the child from abuse when the person knew or reasonably should have known that the child was in danger of abuse.

The District Attorney's office shall be notified in all instances of known or suspected child abuse or neglect reported to this department. Notification of the District Attorney is not required for reports only involving neglect by a person, who has the care or custody of a child, to provide adequate food, clothing, shelter, medical care, or supervision where no physical injury to the child has occurred (Penal Code § 11166).

When the abuse or neglect occurs at a licensed facility or is alleged to have resulted from the actions of a person who is required to have a state license (e.g., foster homes, group homes, day care), notification shall also be made to the California Department of Social Services or other applicable licensing authority. When the alleged abuse or neglect involves a child of a minor parent or a dependent adult, notification shall also be made to the attorney of the minor or the dependent adult within 36 hours (Penal Code 11166.1; Penal Code 11166.2).

Culver City Police Department

Culver City PD Policy Manual

Child Abuse

For purposes of notification, the abuse or neglect includes physical injury or death inflicted by other than accidental means upon a child by another person; sexual abuse (Penal Code § 11165.1); neglect (Penal Code § 11165.2); the willful harming or injuring of a child or the endangering of the person or health of a child (Penal Code § 11165.3); and unlawful corporal punishment or injury (Penal Code § 11165.4). Child abuse or neglect does not include a mutual affray between minors, nor does it include an injury caused by the reasonable and necessary force used by a peace officer acting within the course and scope of the peace officer's employment as a peace officer.

317.3.1 NOTIFICATION PROCEDURE

Notification should occur as follows (Penal Code § 11166):

- (a) Notification shall be made immediately, or as soon as practicable, by telephone, fax or electronic transmission.
- (b) A written follow-up report should be forwarded within 36 hours of receiving the information concerning the incident.

317.4 QUALIFIED INVESTIGATORS

Qualified investigators should be available for child abuse investigations. These investigators should:

- (a) Conduct interviews in child appropriate interview facilities.
- (b) Be familiar with forensic interview techniques specific to child abuse investigations.
- (c) Present all cases of alleged child abuse to the prosecutor for review.
- (d) Coordinate with other enforcement agencies, social service agencies and school administrators as needed.
- (e) Provide referrals to therapy services, victim advocates, guardians and support for the child and family as appropriate.
- (f) Participate in or coordinate with multidisciplinary investigative teams as applicable (Welfare and Institutions Code § 18961.7).

317.5 INVESTIGATIONS AND REPORTING

In all reported or suspected cases of child abuse, a report will be written. Officers shall write a report even if the allegations appear unfounded or unsubstantiated.

Investigations and reports related to suspected cases of child abuse should address, as applicable:

- (a) The overall basis for the contact. This should be done by the investigating officer in all circumstances where a suspected child abuse victim was contacted.
- (b) The exigent circumstances that existed if officers interviewed the child victim without the presence of a parent or guardian.

Culver City Police Department

Culver City PD Policy Manual

Child Abuse

- (c) Any relevant statements the child may have made and to whom he/she made the statements.
- (d) If a child was taken into protective custody, the reasons, the name and title of the person making the decision, and why other alternatives were not appropriate.
- (e) Documentation of any visible injuries or any injuries identified by the child. This should include photographs of such injuries, if practicable.
- (f) Whether the child victim was transported for medical treatment or a medical examination.
- (g) Whether the victim identified a household member as the alleged perpetrator, and a list of the names of any other children who may reside in the residence.
- (h) Identification of any prior related reports or allegations of child abuse, including other jurisdictions, as reasonably known.
- (i) Previous addresses of the victim and suspect.
- (j) Other potential witnesses who have not yet been interviewed, such as relatives or others close to the victim's environment.

All cases of the unexplained death of a child should be investigated as thoroughly as if it had been a case of suspected child abuse (e.g., a sudden or unexplained death of an infant).

317.5.1 EXTRA JURISDICTIONAL REPORTS

If a report of known or suspected child abuse or neglect that is alleged to have occurred outside this jurisdiction is received, department members shall ensure that the caller is immediately transferred to the agency with proper jurisdiction for the investigation of the case. If the caller cannot be successfully transferred to the appropriate agency, a report shall be taken and immediately referred by telephone, fax, or electronic transfer to the agency with proper jurisdiction (Penal Code § 11165.9).

317.5.2 INITIAL REPORTS OF ABUSE FROM A NONMANDATED REPORTER

Members who receive a report of child abuse or neglect shall request the following information from the reporter (Penal Code § 11167):

- (a) Name and telephone number
- (b) Information and the source of information that gives rise to the knowledge or reasonable suspicion of child abuse or neglect

If the reporter refuses to provide their name and telephone number, the member should make a reasonable effort to determine the basis for the refusal and inform them that their information will remain confidential.

Culver City Police Department

Culver City PD Policy Manual

Child Abuse

317.6 PROTECTIVE CUSTODY

Before taking any child into protective custody, the officer should make reasonable attempts to contact CPS. Generally, removal of a child from the child's family, guardian, or other responsible adult should be left to the child welfare authorities when they are present or have become involved in an investigation.

Generally, members of this department should remove a child from the child's parent or guardian without a court order only when no other effective alternative is reasonably available and immediate action reasonably appears necessary to protect the child. Prior to taking a child into protective custody, the officer should take reasonable steps to deliver the child to another qualified parent or legal guardian, unless it reasonably appears that the release would endanger the child or result in abduction. If this is not a reasonable option, the officer shall ensure that the child is delivered to CPS.

Whenever practicable, the officer should inform a supervisor of the circumstances prior to taking a child into protective custody. If prior notification is not practicable, officers should contact a supervisor promptly after taking a child into protective custody.

Children may only be removed from a parent or guardian in the following situations when a court order cannot reasonably be obtained in a timely manner (Welfare and Institutions Code § 305):

- (a) The officer reasonably believes the child is a person described in Welfare and Institutions Code § 300, and further has good cause to believe that any of the following conditions exist:
 1. The child has an immediate need for medical care.
 2. The child is in immediate danger of physical or sexual abuse.
 3. The physical environment or the fact that the child is left unattended poses an immediate threat to the child's health or safety. In the case of a child left unattended, the officer shall first attempt to locate and determine if a responsible parent or guardian is available and capable of assuming custody before taking the child into protective custody.
- (b) The officer reasonably believes the child requires protective custody under the provisions of Penal Code § 279.6, in one of the following circumstances:
 1. It reasonably appears to the officer that a person is likely to conceal the child, flee the jurisdiction with the child or, by flight or concealment, evade the authority of the court.
 2. There is no lawful custodian available to take custody of the child.
 3. There are conflicting custody orders or conflicting claims to custody and the parties cannot agree which party should take custody of the child.
 4. The child is an abducted child.
- (c) The child is in the company of, or under the control of, a person arrested for Penal Code § 278 (Detainment or concealment of child from legal custodian) or Penal Code § 278.5 (Deprivation of custody of a child or right to visitation) (Penal Code § 279.6).

Culver City Police Department

Culver City PD Policy Manual

Child Abuse

A child taken into protective custody shall be delivered to CPS unless otherwise directed by court order.

317.6.1 CALIFORNIA SAFELY SURRENDERED BABY LAW

An individual having lawful custody of an infant less than 72 hours old is not guilty of abandonment if the individual voluntarily surrenders physical custody of the infant to personnel on-duty at a safe-surrender site, such as a hospital or fire department (Penal Code § 271.5). The law requires the surrender site to notify CPS.

317.6.2 NEWBORNS TESTING POSITIVE FOR DRUGS

Under certain circumstances, officers can be prohibited from taking a newborn who is the subject of a proposed adoption into protective custody, even when the newborn has tested positive for illegal drugs or the birth mother tested positive for illegal drugs.

Officers shall instead follow the provisions of Welfare and Institutions Code § 305.6 to ensure that the newborn is placed with the adoptive parents when it is appropriate.

317.7 INTERVIEWS

317.7.1 PRELIMINARY INTERVIEWS

Absent extenuating circumstances or impracticality, officers should record the preliminary interview with suspected child abuse victims. Officers should avoid multiple interviews with a child victim and should attempt to gather only the information necessary to begin an investigation. When practicable, investigating officers should defer interviews until a person who is specially trained in such interviews is available. Generally, child victims should not be interviewed in the home or location where the alleged abuse occurred.

317.7.2 DETAINING SUSPECTED CHILD ABUSE VICTIMS FOR AN INTERVIEW

An officer should not detain a child involuntarily who is suspected of being a victim of child abuse solely for the purpose of an interview or physical exam without the consent of a parent or guardian unless one of the following applies:

- (a) Exigent circumstances exist, such as:
 1. A reasonable belief that medical issues of the child need to be addressed immediately.
 2. A reasonable belief that the child is or will be in danger of harm if the interview or physical exam is not immediately completed.
 3. The alleged offender is the custodial parent or guardian and there is reason to believe the child may be in continued danger.
- (b) A court order or warrant has been issued.

Culver City Police Department

Culver City PD Policy Manual

Child Abuse

317.7.3 INTERVIEWS AT A SCHOOL

Any student at school who is a suspected victim of child abuse shall be afforded the option of being interviewed in private or selecting any qualified available adult member of the school staff to be present. The purpose of the staff member's presence is to provide comfort and support. The staff member shall not participate in the interview. The selection of a staff member should be such that it does not burden the school with costs or hardship (Penal Code § 11174.3).

317.8 MEDICAL EXAMINATIONS

If the child has been the victim of abuse that requires a medical examination, the investigating officer should obtain consent for such examination from the appropriate parent, guardian or agency having legal custody of the child. The officer should also arrange for the child's transportation to the appropriate medical facility.

In cases where the alleged offender is the custodial parent or guardian and is refusing consent for the medical examination, officers should notify a supervisor before proceeding. If exigent circumstances do not exist or if state law does not provide for officers to take the child for a medical examination, the notified supervisor should consider obtaining a court order for such an examination.

317.9 DRUG-ENDANGERED CHILDREN

A coordinated response by law enforcement and social services agencies is appropriate to meet the immediate and longer-term medical and safety needs of children exposed to the manufacturing, trafficking or use of narcotics.

317.9.1 SUPERVISOR RESPONSIBILITIES

The Detective Bureau supervisor should:

- (a) Work with professionals from the appropriate agencies, including CPS, other law enforcement agencies, medical service providers and local prosecutors to develop community specific procedures for responding to situations where there are children endangered by exposure to methamphetamine labs or the manufacture and trafficking of other drugs.
- (b) Activate any available interagency response when an officer notifies the Detective Bureau supervisor that the officer has responded to a drug lab or other narcotics crime scene where a child is present or where evidence indicates that a child lives there.
- (c) Develop a report format or checklist for use when officers respond to drug labs or other narcotics crime scenes. The checklist will help officers document the environmental, medical, social and other conditions that may affect the child.

317.9.2 OFFICER RESPONSIBILITIES

Officers responding to a drug lab or other narcotics crime scene where a child is present or where there is evidence that a child lives should:

Culver City Police Department

Culver City PD Policy Manual

Child Abuse

- (a) Document the environmental, medical, social and other conditions of the child using photography as appropriate and the checklist or form developed for this purpose.
- (b) Notify the Detective Bureau supervisor so an interagency response can begin.

317.10 STATE MANDATES AND OTHER RELEVANT LAWS

California requires or permits the following:

317.10.1 RELEASE OF REPORTS

Information related to incidents of child abuse or suspected child abuse shall be confidential and may only be disclosed pursuant to state law and the Records Maintenance and Release Policy (Penal Code § 841.5; Penal Code § 11167.5).

317.10.2 REQUESTS FOR REMOVAL FROM THE CHILD ABUSECENTRAL INDEX (CACI)

Any person whose name has been forwarded to the California Department of Justice (DOJ) for placement in California's CACI, as a result of an investigation, may request that his/her name be removed from the CACI list. Requests shall not qualify for consideration if there is an active case, ongoing investigation or pending prosecution that precipitated the entry to CACI (Penal Code § 11169). All requests for removal shall be submitted in writing by the requesting person and promptly routed to the CACI hearing officer.

317.10.3 CACI HEARING OFFICER

The Detective Bureau supervisor will normally serve as the hearing officer but must not be actively connected with the case that resulted in the person's name being submitted to CACI. Upon receiving a qualified request for removal, the hearing officer shall promptly schedule a hearing to take place during normal business hours and provide written notification of the time and place of the hearing to the requesting party.

317.10.4 CACI HEARING PROCEDURES

The hearing is an informal process where the person requesting removal from the CACI list will be permitted to present relevant evidence (e.g., certified copy of an acquittal, factual finding of innocence) as to why his/her name should be removed. The person requesting the hearing may record the hearing at his/her own expense.

Formal rules of evidence will not apply and the hearing officer may consider, in addition to evidence submitted by the person requesting the hearing, any relevant information including, but not limited to, the following:

- (a) Case reports including any supplemental reports
- (b) Statements by investigators
- (c) Statements from representatives of the District Attorney's Office
- (d) Statements by representatives of a child protective agency who may be familiar with the case

Culver City Police Department

Culver City PD Policy Manual

Child Abuse

After considering all information presented, the hearing officer shall make a determination as to whether the requesting party's name should be removed from the CACI list. Such determination shall be based on a finding that the allegations in the investigation are not substantiated (Penal Code § 11169).

If, after considering the evidence, the hearing officer finds that the allegations are not substantiated, he/she shall cause a request to be completed and forwarded to the DOJ that the person's name be removed from the CACI list. A copy of the hearing results and the request for removal will be attached to the case reports.

The findings of the hearing officer shall be considered final and binding.

317.10.5 CHILD DEATH REVIEW TEAM

This department should cooperate with any interagency child death review team investigation. Written and oral information relating to the death of a child that would otherwise be subject to release restrictions may be disclosed to the child death review team upon written request and approval of a supervisor (Penal Code § 11174.32).

317.11 TRAINING

The Department should provide training on best practices in child abuse investigations to members tasked with investigating these cases. The training should include:

- (a) Participating in multidisciplinary investigations, as appropriate.
- (b) Conducting forensic interviews.
- (c) Availability of therapy services for children and families.
- (d) Availability of specialized forensic medical exams.
- (e) Cultural competence (including interpretive services) related to child abuse investigations.
- (f) Availability of victim advocate or guardian ad litem support.

Missing Persons

318.1 PURPOSE AND SCOPE

This policy provides guidance for handling missing person investigations.

318.1.1 DEFINITIONS

Definitions related to this policy include:

At risk - Includes but is not limited to (Penal Code § 14215):

- A victim of a crime or foul play
- A person missing and in need of medical attention
- A missing person with no pattern of running away or disappearing
- A missing person who may be the victim of parental abduction
- A mentally impaired missing person, including cognitively impaired or developmentally disabled

Missing person - Any person who is reported missing to law enforcement when the person's location is unknown. This includes a child who has been taken, detained, concealed, enticed away, or kept by a parent in violation of the law (Penal Code § 277 et seq.). It also includes any child who is missing voluntarily, involuntarily, or under circumstances that do not conform to their ordinary habits or behavior, and who may be in need of assistance (Penal Code § 14215).

Missing person networks - Databases or computer networks that are available to law enforcement and that are suitable for obtaining information related to missing persons investigations. This includes the National Crime Information Center (NCIC), the National Missing and Unidentified Persons System (NamUs), the California Law Enforcement Telecommunications System (CLETS), the Missing Person System (MPS), and the Unidentified Persons System (UPS).

318.2 POLICY

The Culver City Police Department does not consider any report of a missing person to be routine and assumes that the missing person is in need of immediate assistance until an investigation reveals otherwise. The Culver City Police Department gives missing person cases priority over property-related cases and will not require any time frame to pass before beginning a missing person investigation (Penal Code § 14211).

318.3 REQUIRED FORMS AND BIOLOGICAL SAMPLE COLLECTION KITS

The Investigations Bureau supervisor should ensure the forms and kits are developed and available in accordance with this policy, state law, federal law and the California Peace Officer Standards and Training (POST) Missing Persons Investigations guidelines, including:

- Department report form for use in missing person cases

Culver City Police Department

Culver City PD Policy Manual

Missing Persons

- Missing person investigation checklist that provides investigation guidelines and resources that could be helpful in the early hours of a missing person investigation (Penal Code § 13519.07)
- Missing person school notification form
- Medical records release form from the California Department of Justice
- California DOJ missing person forms as appropriate
- Biological sample collection kits

318.4 ACCEPTANCE OF REPORTS

Any member encountering a person who wishes to report a missing person or runaway shall render assistance without delay (Penal Code § 14211). This can be accomplished by accepting the report via telephone or in-person and initiating the investigation. Those members who do not take such reports or who are unable to render immediate assistance shall promptly dispatch or alert a member who can take the report.

A report shall be accepted in all cases and regardless of where the person was last seen, where the person resides or any other question of jurisdiction (Penal Code § 14211).

318.5 INITIAL INVESTIGATION

Officers or other members conducting the initial investigation of a missing person should take the following investigative actions, as applicable:

- (a) Respond to a dispatched call as soon as practicable.
- (b) Interview the reporting party and any witnesses to determine whether the person qualifies as a missing person and, if so, whether the person may be at risk.
- (c) Notify a supervisor immediately if there is evidence that a missing person is either at risk or may qualify for a public alert, or both (see the Public Alerts Policy).
- (d) Broadcast a "Be on the Look-Out (BOLO) bulletin" if the person is under 21 years of age or there is evidence that the missing person is at risk. The BOLO should be broadcast as soon as practicable but in no event more than one hour after determining the missing person is under 21 years of age or may be at risk (Penal Code § 14211).
- (e) Ensure that entries are made into the appropriate missing person networks as follows:
 1. Immediately, when the missing person is at risk.
 2. In all other cases, as soon as practicable, but not later than two hours from the time of the initial report (34 USC § 41308).
- (f) Complete the appropriate report forms accurately and completely and initiate a search as applicable according to the facts.
- (g) Collect and/or review:
 1. A photograph and a fingerprint card of the missing person, if available.
 2. A voluntarily provided biological sample of the missing person, if available (e.g., toothbrush, hairbrush).

Culver City Police Department

Culver City PD Policy Manual

Missing Persons

3. Any documents that may assist in the investigation, such as court orders regarding custody.
 4. Any other evidence that may assist in the investigation, including personal electronic devices (e.g., cell phones, computers).
- (h) When circumstances permit and if appropriate, attempt to determine the missing person's location through their telecommunications carrier.
- (i) Contact the appropriate agency if the report relates to a missing person report previously made to another agency and that agency is actively investigating the report. When this is not practicable, the information should be documented in an appropriate report for transmission to the appropriate agency. If the information relates to an at-risk missing person, the member should notify a supervisor and proceed with reasonable steps to locate the missing person.

318.6 REPORT PROCEDURES AND ROUTING

Employees should complete all missing person reports and forms promptly and advise the appropriate supervisor as soon as a missing person report is ready for review.

318.6.1 SUPERVISOR RESPONSIBILITIES

The responsibilities of the supervisor shall include, but are not limited to:

- (a) Reviewing and approving missing person reports upon receipt.
 1. The reports should be promptly sent to the Records Section.
- (b) Ensuring resources are deployed as appropriate.
- (c) Initiating a command post as needed.
- (d) Ensuring applicable notifications and public alerts are made and documented.
- (e) Ensuring that records have been entered into the appropriate missing persons networks.
- (f) Taking reasonable steps to identify and address any jurisdictional issues to ensure cooperation among agencies.

If the case falls within the jurisdiction of another agency, the supervisor should facilitate transfer of the case to the agency of jurisdiction.

318.6.2 RECORDS SECTION RESPONSIBILITIES

The responsibilities of the receiving member shall include but are not limited to:

- (a) As soon as reasonable under the circumstances, notifying and forwarding a copy of the report to the agency of jurisdiction for the missing person's residence in cases where the missing person is a resident of another jurisdiction (Penal Code § 14211).
- (b) Notifying and forwarding a copy of the report to the agency of jurisdiction where the missing person was last seen (Penal Code § 14211).
- (c) Notifying and forwarding a copy of the report to the agency of jurisdiction for the missing person's intended or possible destination, if known.

Culver City Police Department

Culver City PD Policy Manual

Missing Persons

- (d) Forwarding a copy of the report to the Detective Bureau.
- (e) Coordinating with the NCIC Terminal Contractor for California to have the missing person record in the NCIC computer networks updated with additional information obtained from missing person investigations (34 USC § 41308).

318.7 DETECTIVE BUREAU FOLLOW-UP

In addition to completing or continuing any actions listed above, the investigator assigned to a missing person investigation:

- (a) Shall ensure that the missing person's school is notified within 10 days if the missing person is a juvenile.
 - 1. The notice shall be in writing and should also include a photograph (Education Code § 49068.6).
 - 2. The investigator should meet with school officials as appropriate to stress the importance of including the notice in the child's student file, along with the investigator's contact information if the school receives a call requesting the transfer of the missing child's files to another school.
- (b) Should recontact the reporting party and/or other witnesses within 30 days of the initial report and within 30 days thereafter to keep them informed, as appropriate, and to determine if any additional information has become available.
- (c) Should consider contacting other agencies involved in the case to determine if any additional information is available.
- (d) Shall verify and update CLETS, NCIC, and any other applicable missing person networks within 30 days of the original entry into the networks and every 30 days thereafter until the missing person is located (34 USC § 41308).
- (e) Should continue to make reasonable efforts to locate the missing person and document these efforts at least every 30 days.
- (f) Shall maintain a close liaison with state and local child welfare systems and the National Center for Missing and Exploited Children (NCMEC) if the missing person is under the age of 21 and shall promptly notify NCMEC when the person is missing from a foster care family home or childcare institution (34 USC § 41308).
- (g) Should make appropriate inquiry with the Coroner.
- (h) Should obtain and forward medical and dental records, photos, X-rays, and biological samples pursuant to Penal Code § 14212 and Penal Code § 14250.
- (i) Shall attempt to obtain the most recent photograph for persons under 18 years of age if it has not been obtained previously and forward the photograph to California DOJ (Penal Code § 14210) and enter the photograph into applicable missing person networks (34 USC § 41308).
- (j) In the case of an at-risk missing person or a person who has been missing for an extended time, should consult with a supervisor regarding seeking federal assistance from the FBI and the U.S. Marshals Service (28 USC § 566).

Culver City Police Department

Culver City PD Policy Manual

Missing Persons

318.8 WHEN A MISSING PERSON IS FOUND

When any person reported missing is found, the assigned investigator shall document the location of the missing person in the appropriate report, notify the relatives and/or reporting party, as appropriate, and other involved agencies and refer the case for additional investigation if warranted.

The Records Supervisor shall ensure that, upon receipt of information that a missing person has been located, the following occurs (Penal Code § 14213):

- (a) Notification is made to California DOJ.
- (b) The missing person's school is notified.
- (c) Entries are made in the applicable missing person networks.
- (d) Immediately notify the Attorney General's Office.
- (e) Notification shall be made to any other law enforcement agency that took the initial report or participated in the investigation within 24 hours.

318.8.1 UNIDENTIFIED PERSONS

Members investigating a case of an unidentified person who is deceased or a living person who cannot assist in identifying themselves should:

- (a) Obtain a complete description of the person.
- (b) Enter the unidentified person's description into the NCIC Unidentified Person File and the NamUs database.
- (c) Use available resources, such as those related to missing persons, to identify the person.

318.9 CASE CLOSURE

The Special Operations Bureau supervisor may authorize the closure of a missing person case after considering the following:

- (a) Closure is appropriate when the missing person is confirmed returned or evidence has matched an unidentified person or body.
- (b) If the missing person is a resident of Culver City or this department is the lead agency, the case should be kept under active investigation for as long as the person may still be alive. Exhaustion of leads in the investigation should not be a reason for closing a case.
- (c) If this department is not the lead agency, the case can be made inactive if all investigative leads have been exhausted, the lead agency has been notified and entries are made in the applicable missing person networks as appropriate.
- (d) A missing person case should not be closed or reclassified because the person would have reached a certain age or adulthood or because the person is now the subject of a criminal or civil warrant.

Culver City Police Department

Culver City PD Policy Manual

Missing Persons

318.10 TRAINING

Subject to available resources, the Personnel and Training Lieutenant should ensure that members of this department whose duties include missing person investigations and reports receive regular training that includes:

- (a) The initial investigation:
 - 1. Assessments and interviews
 - 2. Use of current resources, such as Mobile Audio Video (MAV)
 - 3. Confirming missing status and custody status of minors
 - 4. Evaluating the need for a heightened response
 - 5. Identifying the zone of safety based on chronological age and developmental stage
- (b) Briefing of department members at the scene.
- (c) Identifying NCIC Missing Person File categories (e.g., disability, endangered, involuntary, juvenile and catastrophe).
- (d) Verifying the accuracy of all descriptive information.
- (e) Initiating a neighborhood investigation.
- (f) Investigating any relevant recent family dynamics.
- (g) Addressing conflicting information.
- (h) Key investigative and coordination steps.
- (i) Managing a missing person case.
- (j) Additional resources and specialized services.
- (k) Update procedures for case information and descriptions.
- (l) Preserving scenes.
- (m) Internet and technology issues (e.g., Internet use, cell phone use).
- (n) Media relations.

Public Alerts

319.1 PURPOSE AND SCOPE

The purpose of this policy is to provide guidelines for alerting the public to important information and soliciting public aid when appropriate.

319.2 POLICY

Public alerts may be employed using the Emergency Alert System (EAS), local radio, television, social media, press organizations and other groups to notify the public of incidents, or enlist the aid of the public, when the exchange of information may enhance the safety of the community. Various types of alerts may be available based upon each situation and the alert system's individual criteria.

319.3 RESPONSIBILITIES

319.3.1 MEMBER RESPONSIBILITIES

Members of the Culver City Police Department should notify their supervisor, Watch Commander, or Detective Bureau Supervisor as soon as practicable upon learning of a situation where public notification, a warning, or enlisting the help of the media and public could assist in locating a missing person, apprehending a dangerous person, or gathering information.

319.3.2 SUPERVISOR RESPONSIBILITIES

A supervisor apprised of the need for a public alert is responsible to make the appropriate notifications based upon the circumstances of each situation. The supervisor shall promptly notify the Chief of Police, the appropriate Bureau Commander and the Public Information Officer when any public alert is generated.

The supervisor in charge of the investigation to which the alert relates is responsible for the following:

- (a) Updating alerts
- (b) Canceling alerts
- (c) Ensuring all appropriate reports are completed
- (d) Preparing an after-action evaluation of the investigation to be forwarded to the Bureau Commander

319.4 AMBER ALERTS

The AMBER Alert™ Program is a voluntary partnership between law enforcement agencies, broadcasters, transportation agencies and the wireless industry, to activate urgent bulletins in child abduction cases.

319.4.1 CRITERIA FOR AMBER ALERT

The following conditions must be met before activating an AMBER Alert (Government Code § 8594(a)):

Culver City Police Department

Culver City PD Policy Manual

Public Alerts

- (a) A child has been abducted or taken by anyone, including but not limited to a custodial parent or guardian.
- (b) The victim is 17 years of age or younger, or has a proven mental or physical disability.
- (c) The victim is in imminent danger of serious injury or death.
- (d) There is information available that, if provided to the public, could assist in the child's safe recovery.

319.4.2 PROCEDURE FOR AMBER ALERT

The supervisor in charge will ensure the following:

- (a) An initial press release is prepared that includes all available information that might aid in locating the child:
 - 1. The child's identity, age and description
 - 2. Photograph if available
 - 3. The suspect's identity, age and description, if known
 - 4. Pertinent vehicle description
 - 5. Detail regarding location of incident, direction of travel, potential destinations, if known
 - 6. Name and telephone number of the Public Information Officer or other authorized individual to handle media liaison
 - 7. A telephone number for the public to call with leads or information
- (b) The local California Highway Patrol communications center should be contacted to initiate a multi-regional or statewide EAS broadcast, following any policies and procedures developed by CHP (Government Code § 8594).
- (c) The press release information is forwarded to the Sheriff's Department Emergency Communications Bureau so that general broadcasts can be made to local law enforcement agencies.
- (d) Information regarding the missing person should be entered into the California Law Enforcement Telecommunication System (CLETS).
- (e) Information regarding the missing person should be entered into the California Department of Justice Missing and Unidentified Persons System (MUPS)/National Crime Information Center (NCIC).
- (f) The following resources should be considered as circumstances dictate:
 - 1. The local FBI office
 - 2. National Center for Missing and Exploited Children (NCMEC)

319.5 BLUE ALERTS

Blue Alerts may be issued when an officer is killed, injured or assaulted and the suspect may pose a threat to the public or other law enforcement personnel.

Culver City Police Department

Culver City PD Policy Manual

Public Alerts

319.5.1 CRITERIA FOR BLUE ALERTS

All of the following conditions must be met before activating a Blue Alert (Government Code § 8594.5):

- (a) A law enforcement officer has been killed, suffered serious bodily injury or has been assaulted with a deadly weapon, and the suspect has fled the scene of the offense.
- (b) The investigating law enforcement agency has determined that the suspect poses an imminent threat to the public or other law enforcement personnel.
- (c) A detailed description of the suspect's vehicle or license plate is available for broadcast.
- (d) Public dissemination of available information may help avert further harm or accelerate apprehension of the suspect.

319.5.2 PROCEDURE FOR BLUE ALERT

The supervisor in charge should ensure the following:

- (a) An initial press release is prepared that includes all available information that might aid in locating the suspect:
 - 1. The license number and/or any other available description or photograph of the vehicle
 - 2. Photograph, description and/or identification of the suspect
 - 3. The suspect's identity, age and description, if known
 - 4. Detail regarding location of incident, direction of travel, potential destinations, if known
 - 5. Name and telephone number of the Public Information Officer or other authorized individual to handle media liaison
 - 6. A telephone number for the public to call with leads or information
- (b) The local California Highway Patrol communications center is contacted to initiate a multi-regional or statewide EAS broadcast.
- (c) The information in the press release is forwarded to the Sheriff's Department Emergency Communications Bureau so that general broadcasts can be made to local law enforcement agencies.
- (d) The following resources should be considered as circumstances dictate:
 - 1. Entry into the California Law Enforcement Telecommunication System (CLETS)
 - 2. The FBI local office

319.6 SILVER ALERTS

Silver Alerts® is an emergency notification system for people who are 65 years of age or older, developmentally disabled or cognitively impaired and have been reported missing (Government Code § 8594.10).

Culver City Police Department

Culver City PD Policy Manual

Public Alerts

319.6.1 CRITERIA FOR SILVER ALERTS

All of the following conditions must be met before activating a Silver Alert (Government Code § 8594.10):

- (a) The missing person is 65 years of age or older, developmentally disabled or cognitively impaired.
- (b) The department has utilized all available local resources.
- (c) The investigating officer or supervisor has determined that the person is missing under unexplained or suspicious circumstances.
- (d) The investigating officer or supervisor believes that the person is in danger because of age, health, mental or physical disability, environment or weather conditions, that the person is in the company of a potentially dangerous person, or that there are other factors indicating that the person may be in peril.
- (e) There is information available that, if disseminated to the public, could assist in the safe recovery of the missing person.

319.6.2 PROCEDURE FOR SILVER ALERT

Requests for a Silver Alert shall be made through the California Highway Patrol (Government Code § 8594.10).

319.7 MUTUAL AID

The experiences of other law enforcement jurisdictions that have implemented similar plans indicate a public alert will generate a high volume of telephone calls to the handling agency.

The Sheriff's Department emergency communications facilities and staff can be made available in the event of a high call volume.

If the Watch Commander or Detective Bureau Supervisor elects to use the services of the Sheriff's Department, the following will apply:

- (a) Notify the Sheriff's Department Watch Commander of the incident and the request for assistance. The Watch Commander will provide a telephone number for the public to call.
- (b) In the press release, direct the public to the telephone number provided by the Sheriff's Department Watch Commander.
- (c) The Public Information Officer will continue to handle all press releases and media inquiries. Any press inquiries received by the Sheriff's Department will be referred back to this department.

The Culver City Police Department shall assign a minimum of two detectives/officers to respond to the Sheriff's Department emergency communications facility to screen and relay information and any clues received from incoming calls. As circumstances dictate, more staff resources from the handling law enforcement agency may be necessary to assist the staff at the emergency communications facility.

Culver City Police Department

Culver City PD Policy Manual

Public Alerts

319.8 ADDITIONAL ALERTS FOR PUBLIC SAFETY EMERGENCIES

Additional public safety emergency alerts may be authorized that utilize wireless emergency alert system (WEA) and emergency alert system (EAS) equipment for alerting and warning the public to protect lives and save property (Government Code § 8593.7).

319.8.1 CRITERIA

Public safety emergency alerts may be issued to alert or warn the public about events including but not limited to:

- (a) Evacuation orders (including evacuation routes, shelter information, key information).
- (b) Shelter-in-place guidance due to severe weather.
- (c) Terrorist threats.
- (d) HazMat incidents.

319.8.2 PROCEDURE

Public safety emergency alerts should be activated by following the guidelines issued by the Office of Emergency Services (Government Code § 8593.7).

319.9 YELLOW ALERT

A Yellow Alert may be issued when a person is killed due to a hit-and-run incident and the department has specified information concerning the suspect or the suspect's vehicle (Government Code § 8594.15).

319.9.1 CRITERIA FOR YELLOW ALERT

All of the following conditions must be met before activating a Yellow Alert (Government Code § 8594.15):

- (a) A person has been killed due to a hit-and-run incident.
- (b) There is an indication that a suspect has fled the scene utilizing the state highway system or is likely to be observed by the public on the state highway system.
- (c) The department has additional information concerning the suspect or the suspect's vehicle including but not limited to the following:
 - 1. The complete license plate number of the suspect's vehicle.
 - 2. A partial license plate number and additional unique identifying characteristics, such as the make, model, and color of the suspect's vehicle, which could reasonably lead to the apprehension of a suspect.
 - 3. The identity of a suspect.
 - 4. Public dissemination of available information could either help avert further harm or accelerate apprehension of a suspect based on any factor, including but not limited to the time elapsed between a hit-and-run incident and the request or the likelihood that an activation would reasonably lead to the apprehension of a suspect.

Culver City Police Department

Culver City PD Policy Manual

Public Alerts

319.9.2 PROCEDURE FOR YELLOW ALERT

Requests for a Yellow Alert shall be made through the California Highway Patrol (Government Code § 8594.15).

319.10 FEATHER ALERT

A Feather Alert may be issued when an Indigenous person is reported missing. The determination that criteria has been met for the alert shall be made within 24 hours following the initial report being made to the Department (Government Code § 8594.13).

319.10.1 CRITERIA FOR FEATHER ALERT

The Department may request that a Feather Alert be activated if it is determined that the alert would be an effective tool in the investigation of missing and murdered Indigenous persons, including young women or girls. The following factors shall be considered to make that determination (Government Code § 8594.13):

- (a) The missing person is an Indigenous person.
- (b) The Department has utilized local and tribal resources.
- (c) The investigating officer has determined the person is missing.
- (d) The investigating officer or supervisor believes that the person is in danger and missing under circumstances that indicate any of the following:
 1. The missing person's physical safety may be endangered.
 2. The missing person may be subject to trafficking.
 3. The missing person suffers from a mental or physical disability, or substance use disorder.
- (e) There is information available that, if disseminated to the public, could assist in the safe recovery of the missing person.

319.10.2 PROCEDURE FOR FEATHER ALERT

Requests for a Feather Alert shall be made through the California Highway Patrol (Government Code § 8594.13).

319.11 ENDANGERED MISSING ADVISORY

An Endangered Missing Advisory may be requested when a person is reported missing who is developmentally disabled, or cognitively impaired, or has been abducted, or is unable to otherwise care for themselves, placing their physical safety at risk (Government Code § 8594.11).

319.11.1 CRITERIA FOR ENDANGERED MISSING ADVISORY

All of the following conditions must be met before activating an Endangered Missing Advisory (Government Code § 8594.11):

- (a) The missing person is developmentally disabled, cognitively impaired, has been abducted or is otherwise unable to care for themselves, placing their physical safety at risk.

Culver City Police Department

Culver City PD Policy Manual

Public Alerts

- (b) The Department has utilized all available local resources.
- (c) The investigating officer has determined the person has gone missing under unexplained or suspicious circumstances.
- (d) The investigating officer or supervisor believes that the person is in danger because of age, health, mental or physical disability, environment or weather conditions, that the person is in the company of a potentially dangerous person, or that there are other factors indicating that the person may be in peril.
- (e) There is information available that, if disseminated to the public, could assist in the safe recovery of the missing person.

319.11.2 PROCEDURE FOR ENDANGERED MISSING ADVISORIES

Requests for an endangered missing advisory shall be made through the California Highway Patrol (Government Code § 8594.11).

319.12 EBONY ALERT

An Ebony Alert may be requested when it is determined the alert would be an effective tool in the investigation of missing Black youth, including a young woman or girl (Government Code § 8594.14).

319.12.1 CRITERIA FOR EBONY ALERT

The investigating officer may consider the following factors to make the determination that an Ebony Alert would be an effective tool (Government Code § 8594.14):

- (a) The missing person is between the ages of 12 and 25 years old, inclusive.
- (b) The missing person is missing under circumstances that indicate their physical safety is endangered or they have been subject to trafficking.
- (c) The missing person suffers from a mental or physical disability.
- (d) Determination that the person has gone missing under unexplained or suspicious circumstances.
- (e) Belief that the person is in danger because of age, health, mental or physical disability, environment or weather conditions, that the person is in the company of a potentially dangerous person, or that there are other factors indicating that the person may be in peril.
- (f) The Department has utilized all available local resources.
- (g) There is information available that, if disseminated to the public, could assist in the safe recovery of the missing person.

319.12.2 PROCEDURE FOR EBONY ALERT

Requests for an Ebony Alert shall be made through the California Highway Patrol (Government Code § 8594.14).

Culver City Police Department

Culver City PD Policy Manual

Public Alerts

319.13 LANGUAGE REQUIREMENTS FOR PUBLIC EMERGENCIES

In the event of an emergency, as defined in Government Code § 7299.7, the Culver City Police Department shall provide information to the public relating to the emergency in all languages jointly spoken by the local population as provided in Government Code § 7299.7.

Victim and Witness Assistance

320.1 PURPOSE AND SCOPE

The purpose of this policy is to ensure that crime victims and witnesses receive appropriate assistance, that they are provided with information from government and private resources, and that the agency meets all related legal mandates.

320.2 POLICY

The Culver City Police Department is committed to providing guidance and assistance to the victims and witnesses of crime. The members of the Culver City Police Department will show compassion and understanding for victims and witnesses and will make reasonable efforts to provide the support and information identified in this policy.

320.3 CRIME VICTIM LIAISON

The Chief of Police shall appoint a member of the Department to serve as the crime victim liaison (2 CCR 649.36). The crime victim liaison for the department will be the Detective Bureau supervisor. The crime victim liaison will be the point of contact for individuals requiring further assistance or information from the Culver City Police Department regarding benefits from crime victim resources. This person shall also be responsible for maintaining compliance with all legal mandates related to crime victims and/or witnesses.

320.3.1 CRIME VICTIM LIAISON DUTIES

The crime victim liaison is specifically tasked with the following:

- (a) Developing and implementing written procedures for notifying and providing forms for filing with the California Victim Compensation Board (CalVCB) to crime victims, their dependents, or family. Access to information or an application for victim compensation shall not be denied based on the victim's or derivative victim's designation as a gang member, associate, or affiliate, or on the person's documentation or immigration status (Government Code § 13962; 2 CCR 649.35; 2 CCR 649.36).
- (b) Responding to inquiries concerning the procedures for filing a claim with CalVCB (2 CCR 649.36).
- (c) Providing copies of crime reports requested by CalVCB or victim witness assistance centers. Disclosure of reports must comply with the Records Maintenance and Release Policy.
- (d) Annually providing CalVCB with the crime victim liaison's contact information (Government Code § 13962).
- (e) Developing in consultation with sexual assault experts a sexual assault victim card explaining the rights of victims under California law (Penal Code § 680.2).
 1. Ensuring that sufficient copies of the rights of sexual assault victim card are provided to each provider of medical evidentiary examinations or physical examinations arising out of sexual assault in the Culver City Police Department jurisdiction (Penal Code § 680.2).

Culver City Police Department

Culver City PD Policy Manual

Victim and Witness Assistance

- (f) Providing information required by Penal Code § 679.09 of a deceased minor to a parent or guardian of the minor whose death is being investigated.
 - 1. In cases where the parent or guardian of the deceased minor cannot be located, information required by Penal Code § 679.09 shall be provided to the victim's immediate family, upon their request.
- (g) Providing notification to victims of human trafficking or abuse of their right to have a human trafficking advocate and a support person that the victim chooses present during an interview by the Department, prosecutor, or the suspect's defense attorney (Penal Code § 236.21).

320.4 CRIME VICTIMS

Officers should provide all victims with the applicable victim information handouts.

Officers should never guarantee a victim's safety from future harm but may make practical safety suggestions to victims who express fear of future harm or retaliation. Officers should never guarantee that a person qualifies as a victim for the purpose of compensation or restitution but may direct him/her to the proper written department material or available victim resources.

320.4.1 VICTIMS OF HUMAN TRAFFICKING

Officers investigating or receiving a report involving a victim of human trafficking shall inform the victim, or the victim's parent or guardian if the victim is a minor, that upon the request of the victim the names and images of the victim and his/her immediate family members may be withheld from becoming a matter of public record until the conclusion of the investigation or prosecution (Penal Code § 293).

320.5 VICTIM INFORMATION

The Administration Bureau Supervisor shall ensure that victim information handouts are available and current. These should include as appropriate:

- (a) Shelters and other community resources for victims of domestic violence.
- (b) Community resources for victims of sexual assault.
- (c) Assurance that sexual assault victims will not incur out-of-pocket expenses for forensic medical exams, and information about evidence collection, storage, and preservation in sexual assault cases (34 USC § 10449; 34 USC § 20109; Penal Code § 13823.95(a)).
- (d) An explanation that victims of sexual assault who seek a standardized medical evidentiary examination shall not be required to participate or agree to participate in the criminal justice system, either prior to the examination or at any other time (Penal Code § 13823.95(b)).
- (e) An advisement that a person who was arrested may be released on bond or some other form of release and that the victim should not rely upon an arrest as a guarantee of safety.
- (f) A clear explanation of relevant court orders and how they can be obtained.

Culver City Police Department

Culver City PD Policy Manual

Victim and Witness Assistance

- (g) Information regarding available compensation for qualifying victims of crime (Government Code § 13962).
- (h) VINE® information (Victim Information and Notification Everyday), including the telephone number and whether this free service is available to allow victims to check on an offender's custody status and to register for automatic notification when a person is released from jail.
- (i) Notice regarding U visa and T visa application processes.
- (j) Resources available for victims of identity theft.
- (k) A place for the officer's name, badge number, and any applicable case or incident number.
- (l) The "Victims of Domestic Violence" card containing the names, phone numbers, or local county hotlines of local shelters for battered women and rape victim counseling centers within the county and their 24-hour counseling service telephone numbers (Penal Code § 264.2).
- (m) The rights of sexual assault victims card with the required information as provided in Penal Code § 680.2.
- (n) Any additional information required by state law (Penal Code § 13701; Penal Code § 679.02; Penal Code § 679.04; Penal Code § 679.05; Penal Code § 679.026).

320.6 WITNESSES

Officers should never guarantee a witness' safety from future harm or that his/her identity will always remain confidential. Officers may make practical safety suggestions to witnesses who express fear of future harm or retaliation.

Officers should investigate allegations of witness intimidation and take enforcement action when lawful and reasonable.

Hate Crimes

321.1 PURPOSE AND SCOPE

This policy is designed to assist in identifying and handling crimes motivated by hate or other bias toward individuals and groups with legally defined protected characteristics, to define appropriate steps for assisting victims, and to provide a guide to conducting related investigations. It outlines the general policy framework for prevention, response, accessing assistance, victim assistance and follow-up, and reporting as related to law enforcement's role in handling hate crimes. It also serves as a declaration that hate crimes are taken seriously and demonstrates how the Culver City Police Department may best use its resources to investigate and solve an offense, in addition to building community trust and increasing police legitimacy (Penal Code § 13519.6; Penal Code § 422.87).

321.1.1 DEFINITION AND LAWS

In accordance with Penal Code § 422.55; Penal Code § 422.56; Penal Code § 422.6; and Penal Code § 422.87, for purposes of all other state law, unless an explicit provision of law or the context clearly requires a different meaning, the following shall apply:

Bias motivation - Bias motivation is a pre-existing negative attitude toward actual or perceived characteristics referenced in Penal Code § 422.55. Depending on the circumstances of each case, bias motivation may include but is not limited to hatred, animosity, discriminatory selection of victims, resentment, revulsion, contempt, unreasonable fear, paranoia, callousness, thrill-seeking, desire for social dominance, desire for social bonding with those of one's "own kind," or a perception of the vulnerability of the victim due to the victim being perceived as being weak, worthless, or fair game because of a protected characteristic, including but not limited to disability or gender.

Disability - Disability includes mental disability and physical disability as defined in Government Code § 12926, regardless of whether those disabilities are temporary, permanent, congenital, or acquired by heredity, accident, injury, advanced age, or illness.

Disability bias - In recognizing suspected disability-bias hate crimes, officers should consider whether there is any indication that the perpetrator was motivated by hostility or other bias, occasioned by factors such as but not limited to dislike of persons who arouse fear or guilt, a perception that persons with disabilities are inferior and therefore "deserving victims," a fear of persons whose visible traits are perceived as being disturbing to others, or resentment of those who need, demand, or receive alternative educational, physical, or social accommodations.

In recognizing suspected disability-bias hate crimes, officers should consider whether there is any indication that the perpetrator perceived the victim to be vulnerable and, if so, if this perception is grounded, in whole or in part, in anti-disability bias. This includes but is not limited to situations where a perpetrator targets a person with a particular perceived disability while avoiding other vulnerable-appearing persons, such as inebriated persons or persons with perceived disabilities different from those of the victim. Such circumstances could be evidence that the perpetrator's

Culver City Police Department

Culver City PD Policy Manual

Hate Crimes

motivations included bias against persons with the perceived disability of the victim and that the crime must be reported as a suspected hate crime and not a mere crime of opportunity.

Gender - Gender means sex and includes a person's gender identity and gender expression.

Gender expression - Gender expression means a person's gender-related appearance and behavior, regardless of whether it is stereotypically associated with the person's assigned sex at birth.

Gender identity - Gender identity means each person's internal understanding of their gender, or the perception of a person's gender identity, which may include male, female, a combination of male and female, neither male nor female, a gender different from the person's sex assigned at birth, or transgender (2 CCR § 11030).

Hate crime - "Hate crime" includes but is not limited to a violation of Penal Code § 422.6, and means a criminal act committed, in whole or in part, because of one or more of the following actual or perceived characteristics of the victim:

- (a) Disability
- (b) Gender
- (c) Nationality
- (d) Race or ethnicity
- (e) Religion
- (f) Sexual orientation
- (g) Association with a person or group with one or more of these actual or perceived characteristics:
 1. "Association with a person or group with one or more of these actual or perceived characteristics" includes advocacy for, identification with, or being on the premises owned or rented by, or adjacent to, any of the following: a community center, educational facility, family, individual, office, meeting hall, place of worship, private institution, public agency, library, or other entity, group, or person that has, or is identified with people who have, one or more of the characteristics listed in the definition of "hate crime" under paragraphs 1 to 6, inclusive, of Penal Code § 422.55(a).

Note: A "hate crime" need not be motivated by hate but may be motivated by any bias against a protected characteristic.

Hate incident - A hate incident is an action or behavior motivated by hate or bias but legally protected by the First Amendment right to freedom of expression. Examples of hate incidents include:

- Name-calling
- Insults and epithets
- Distributing hate material in public places

Culver City Police Department

Culver City PD Policy Manual

Hate Crimes

- Displaying hate material on your own property

Hate speech - The First Amendment to the U.S. Constitution protects most speech, even when it is disagreeable, offensive, or hurtful. The following types of speech are generally not protected:

- Fighting words
- True threats
- Perjury
- Blackmail
- Incitement to lawless action
- Conspiracy
- Solicitation to commit any crime

In whole or in part - "In whole or in part because of" means that the bias motivation must be a cause in fact of the offense whether or not other causes also exist. When multiple concurrent motives exist, the prohibited bias must be a substantial factor in bringing about the particular result. There is no requirement that the bias be a main factor, or that a crime would not have been committed but for the actual or perceived characteristic.

Nationality - Nationality means country of origin, immigration status, including citizenship, and national origin.

Race or ethnicity - Race or ethnicity includes ancestry, color, and ethnic background.

Religion - Religion includes all aspects of religious belief, observance, and practice and includes agnosticism and atheism.

Religious bias - In recognizing suspected religion-bias hate crimes, officers should consider whether there were targeted attacks on, or biased references to, symbols of importance to a particular religion or articles considered of spiritual significance in a particular religion (e.g., crosses, hijabs, Stars of David, turbans, head coverings, statues of the Buddha).

Sexual orientation - Sexual orientation means heterosexuality, homosexuality, or bisexuality.

Victim - Victim includes but is not limited to:

- Community center
- Educational facility
- Entity
- Family
- Group
- Individual
- Office

Culver City Police Department

Culver City PD Policy Manual

Hate Crimes

- Meeting hall
- Person
- Place of worship
- Private institution
- Public agency
- Library
- Other victim or intended victim of the offense

321.2 POLICY

It is the policy of this department to safeguard the rights of all individuals irrespective of their disability, gender, nationality, race or ethnicity, religion, sexual orientation, and/or association with a person or group with one or more of these actual or perceived characteristics. Any acts or threats of violence, property damage, harassment, intimidation, or other crimes motivated by hate or bias should be viewed very seriously and given high priority.

This department will employ reasonably available resources and vigorous law enforcement action to identify and arrest hate crime perpetrators. Also, recognizing the particular fears and distress typically suffered by victims, the potential for reprisal and escalation of violence, and the far-reaching negative consequences of these crimes on the community, this department should take all reasonable steps to attend to the security and related concerns of the immediate victims and their families as feasible.

All officers are required to be familiar with the policy and use reasonable diligence to carry out the policy unless directed by the Chief of Police or other command-level officer to whom the Chief of Police formally delegates this responsibility.

321.3 PLANNING AND PREVENTION

In order to facilitate the guidelines contained within this policy, department members will continuously work to build and strengthen relationships with the community, engage in dialogue, and provide education to the community about this policy. Department personnel are also encouraged to learn about the inherent issues concerning their communities in relation to hate crimes.

Although hate incidents are not criminal events, they can be indicators of, or precursors to, hate crimes. Hate incidents should be investigated and documented as part of an overall strategy to prevent hate crimes.

321.3.1 HATE CRIMES COORDINATOR

A department member appointed by the Chief of Police or the authorized designee will serve as the Hate Crimes Coordinator. The responsibilities of the Hate Crimes Coordinator should include but not be limited to (Penal Code § 422.87):

Culver City Police Department

Culver City PD Policy Manual

Hate Crimes

- (a) Meeting with residents in target communities to allay fears; emphasizing the department's concern over hate crimes and related incidents; reducing the potential for counter-violence; and providing safety, security, and crime-prevention information. Cultural diversity education and immersion programs (if available) could facilitate this process.
- (b) Finding, evaluating, and monitoring public social media sources to identify possible suspects in reported hate crimes; to identify suspects or suspect groups in future hate crimes or hate incidents affecting individuals, groups, or communities that may be victimized; and to predict future hate-based events.
- (c) Providing direct and referral assistance to the victim and the victim's family.
- (d) Conducting public meetings on hate crime threats and violence in general.
- (e) Establishing relationships with formal community-based organizations and leaders.
- (f) Expanding, where appropriate, preventive programs such as hate, bias, and crime-reduction seminars for students.
- (g) Reviewing the Attorney General's latest opinion on hate crime statistics and targets in order to prepare and plan for future crimes, specifically for Arab, Middle Eastern, Islamic, lesbian, gay, bisexual, transgender, and queer or questioning (LGBTQ), Black, Native American, immigrant, Jewish, Asian American, and Pacific Islander communities (Penal Code § 13519.6(b)(8)).
- (h) Providing orientation of and with communities of specific targeted victims such as immigrant, Muslim, Arab, LGBTQ, Black or African-American, Jewish, and Sikh persons and persons with disabilities.
- (i) Coordinating with the Personnel and Training Lieutenant to develop a schedule of required hate-crime training and include in a training plan recognition of hate crime bias characteristics, including information on general underreporting of hate crimes.
- (j) Verifying a process is in place to provide this policy and related orders to officers in the field and taking reasonable steps to rectify the situation if such a process is not in place.
- (k) Taking reasonable steps to ensure hate crime data is provided to the Records Section for mandated reporting to the California Department of Justice.
 - 1. Ensure the California Department of Justice crime data is posted monthly on the department website (Penal Code § 13023).
- (l) Reporting any suspected multi-mission extremist crimes to the department Terrorism Liaison Officer, the assigned designee, or other appropriate resource; and verifying that such data is transmitted to the Joint Regional Information Exchange System in accordance with the protocols of the Records Section Policy.
- (m) Maintaining the department's supply of up-to-date hate crimes brochures (Penal Code § 422.92; Penal Code § 422.87).
- (n) Submitting required hate crime materials to the California Department of Justice in accordance with the timeline established by state law (Penal Code § 13023).

Culver City Police Department

Culver City PD Policy Manual

Hate Crimes

- (o) Annually assessing this policy, including:
 1. Keeping abreast of POST model policy framework for hate crimes for revisions or additions, including definitions, responsibilities, training resources, the supplemental hate crime report, and planning and prevention methods.
 2. Analysis of the department's data collection as well as the available outside data (e.g., annual California Attorney General's report on hate crime) in preparation for and response to future hate crimes.

321.3.2 RELEASE OF INFORMATION

Establishing a relationship with stakeholders, before any incident occurs, to develop a network and protocol for disclosure often assists greatly in any disclosure.

The benefit of public disclosure of hate crime incidents includes:

- (a) Dissemination of correct information.
- (b) Assurance to affected communities or groups that the matter is being properly and promptly investigated.
- (c) The ability to request information regarding the commission of the crimes from the victimized community.

Information or records relating to hate crimes subject to public disclosure shall be released as provided by the Records Maintenance and Release Policy or as allowed by law. In accordance with the Media Relations Policy, the supervisor, public information officer, or the authorized designee should be provided with information that can be responsibly reported to the media. When appropriate, the department spokesperson should reiterate that hate crimes will not be tolerated, will be investigated seriously, and will be prosecuted to the fullest extent of the law.

The Department should consider the following when releasing information to the public regarding hate crimes and hate incidents that have been reported within the jurisdiction:

- Inform community organizations in a timely manner when a community group has been the target of a hate crime.
- Inform the community of the impact of these crimes on the victim, the victim's family, and the community, and of the assistance and compensation available to victims.
- Inform the community regarding hate crime law and the legal rights of, and remedies available to, victims of hate crimes.
- Provide the community with ongoing information regarding hate crimes and/or hate incidents.

321.4 RESPONSE, VICTIM ASSISTANCE, AND FOLLOW-UP

321.4.1 INITIAL RESPONSE

First responding officers should know the role of all department personnel as they relate to the department's investigation of hate crimes and/or incidents. Responding officers should evaluate

Culver City Police Department

Culver City PD Policy Manual

Hate Crimes

the need for additional assistance and, working with supervision and/or investigations, access needed assistance if applicable.

At the scene of a suspected hate or bias crime, officers should take preliminary actions reasonably deemed necessary, including but not limited to the following:

- (a) Use agency checklist (per Penal Code § 422.87) to assist in the investigation of any hate crime (see Appendix).
- (b) Stabilize the victims and request medical attention when necessary.
- (c) Properly protect the safety of victims, witnesses, and perpetrators.
 1. Assist victims in seeking a Temporary Restraining Order (if applicable).
- (d) Notify other appropriate personnel in the chain of command, depending on the nature and seriousness of the offense and its potential inflammatory and related impact on the community.
- (e) Properly protect, preserve, and process the crime scene, and remove all physical evidence of the incident as soon as possible after the offense is documented. If evidence of an inflammatory nature cannot be physically removed, the property owner should be contacted to facilitate removal or covering as soon as reasonably possible. Department personnel should follow up with the property owner to determine if this was accomplished in a timely manner.
- (f) Collect and photograph physical evidence or indicators of hate crimes such as:
 1. Hate literature.
 2. Spray paint cans.
 3. Threatening letters.
 4. Symbols used by hate groups.
- (g) Identify criminal evidence on the victim.
- (h) Request the assistance of translators or interpreters when needed to establish effective communication with witnesses, victims, or others as appropriate.
- (i) Conduct a preliminary investigation and record pertinent information including but not limited to:
 1. Identity of suspected perpetrators.
 2. Identity of witnesses, including those no longer at the scene.
 3. The offer of victim confidentiality per Government Code § 7923.615.
 4. Prior occurrences in this area or with this victim.
 5. Statements made by suspects; exact wording is critical.
 6. The victim's protected characteristics and determine if bias was a motivation "in whole or in part" in the commission of the crime.

Culver City Police Department

Culver City PD Policy Manual

Hate Crimes

- (j) Adhere to Penal Code § 422.93, which protects hate crime victims and witnesses from being reported to federal immigration authorities if they have not committed any crime under state law.
- (k) Provide information regarding immigration remedies available to victims of crime (e.g., U-Visa, T-Visa, S-Visa).
- (l) Provide the department's Hate Crimes Brochure (per Penal Code § 422.92) if asked, if necessary, or per policy.
- (m) Utilize proper techniques for interviewing people with disabilities and be aware of and provide appropriate accommodations (e.g., ADA standards, Braille, visuals, translators for the deaf or hard of hearing).
- (n) Document any suspected multi-mission extremist crimes.

321.4.2 INVESTIGATION

Investigators at the scene of, or performing follow-up investigation on, a suspected hate or bias crime or hate incident should take all actions deemed reasonably necessary, including but not limited to the following:

- (a) Consider typologies of perpetrators of hate crimes and incidents, including but not limited to thrill, reactive/defensive, and mission (hard core).
- (b) Utilize investigative techniques and methods to handle hate crimes or hate incidents in a professional manner.
- (c) Utilize proper techniques for interviewing people with disabilities and be aware of and provide appropriate accommodations (e.g., ADA standards, Braille, visuals, translators for the deaf or hard of hearing).
- (d) Properly investigate any report of a hate crime committed under the color of authority per Penal Code § 422.6 and Penal Code § 13519.6.
- (e) Document physical evidence or indicators of hate crimes, in accordance with the provisions of the Property and Evidence Policy, such as:
 - 1. Hate literature.
 - 2. Spray paint cans.
 - 3. Threatening letters.
 - 4. Symbols used by hate groups.
 - 5. Desecration of religious symbols, objects, or buildings.
- (f) Request the assistance of translators or interpreters when needed to establish effective communication.
- (g) Conduct a preliminary investigation and record information regarding:
 - 1. Identity of suspected perpetrators.
 - 2. Identity of witnesses, including those no longer at the scene.
 - 3. Offer of victim confidentiality per Government Code § 7923.615.

Culver City Police Department

Culver City PD Policy Manual

Hate Crimes

4. Prior occurrences, in this area or with this victim.
 5. Statements made by suspects; exact wording is critical.
 6. Document the victim's protected characteristics.
- (h) Provide victim assistance and follow-up.
- (i) Canvass the area for additional witnesses.
- (j) Examine suspect's social media activity for potential evidence of bias motivation.
- (k) Coordinate the investigation with department, state, and regional intelligence operations. These sources can provide the investigator with an analysis of any patterns, organized hate groups, and suspects potentially involved in the offense.
- (l) Coordinate the investigation with the crime scene investigation unit (if applicable) or other appropriate units of the Department.
- (m) Determine if the incident should be classified as a hate crime.
- (n) Take reasonable steps to provide appropriate assistance to hate crime victims, including the following measures:
1. Contact victims periodically to determine whether they are receiving adequate and appropriate assistance.
 2. Provide ongoing information to victims about the status of the criminal investigation.
 3. Provide victims and any other interested persons the brochure on hate crimes per Penal Code § 422.92 and information on any local advocacy groups (if asked).
- (o) Document any suspected multi-mission extremist crimes.
- (p) Coordinate with other law enforcement agencies in the area to assess patterns of hate crimes and/or hate incidents, and determine if organized hate groups are involved.

321.4.3 SUPERVISION

The supervisor shall confer with the initial responding officer and take reasonable steps to ensure that necessary preliminary actions have been taken. The supervisor shall request any appropriate personnel necessary to accomplish the following:

- (a) Provide immediate assistance to the crime victim by:
1. Expressing the department's official position on the importance of these cases and the measures that will be taken to apprehend the perpetrators.
 2. Expressing the department's interest in protecting victims' anonymity (confidentiality forms, Government Code § 7923.615) to the extent reasonably possible. Allow the victims to convey their immediate concerns and feelings.
 3. Identifying individuals or agencies that may provide victim assistance and support. Local victim assistance resources may include family members or close acquaintances, clergy, or a department chaplain, as well as community service

Culver City Police Department

Culver City PD Policy Manual

Hate Crimes

agencies that provide shelter, food, clothing, child care, or other related services (per Penal Code § 422.92).

- (b) Take reasonable steps to ensure that all relevant facts are documented on an incident and/or arrest report and make an initial determination as to whether the incident should be classified as a hate crime for federal and state bias-crimes reporting purposes.
- (c) Notify other appropriate personnel in the chain of command, depending on the nature and seriousness of the offense and its potential inflammatory and related impact on the community.
- (d) In cases of large-scale hate crime waves, or in circumstances where the potential exists for subsequent hate crimes or incidents, consider directing resources to protect vulnerable sites (such as assigning an officer to specific locations that could become targets).
- (e) Verify hate crimes are being properly reported, including reporting to the Department of Justice, pursuant to Penal Code § 13023.
- (f) Verify adherence to Penal Code § 422.93, which protects hate crime victims and witnesses from being reported to federal immigration authorities if they have not committed any crime under state law. Supervisors should also be aware of the immigration remedies available to victims of crime (e.g., U-Visa, T-Visa, S-Visa).
- (g) Respond to and properly initiate an investigation of any reports of hate crimes committed under the color of authority.
- (h) Provide appropriate assistance, including activating the California Department of Justice hate crime rapid response protocol if necessary. For additional information refer to the California Department of Justice website.
- (i) Verify reporting of any suspected multi-mission extremist crimes to the agency Hate Crimes Coordinator.
- (j) Make a final determination as to whether the incident should be classified as a hate crime and forward to the Chief of Police for approval.

321.5 TRAINING

All members of this department will receive POST-approved training on hate crime recognition and investigation (Penal Code § 13519.6).

Training should include (Penal Code § 422.87):

- (a) Recognition of bias motivators such as ranges of attitudes and perceptions toward a specific characteristic or group, including disability bias, gender bias, and religion bias.
- (b) Accurate reporting by officers, including information on the general underreporting of hate crimes.
- (c) Distribution of hate crime brochures.
- (d) When a gun violence restraining order may be appropriate for prevention of hate crimes (Penal Code § 13519.6).

Culver City Police Department

Culver City PD Policy Manual

Hate Crimes

321.6 APPENDIX

See attachments:

[Statutes and Legal Requirements.pdf](#)

[Hate Crime Checklist.pdf](#)

[Supplemental Hate Crime Report.pdf](#)

Standards of Conduct

322.1 PURPOSE AND SCOPE

This policy establishes standards of conduct that are consistent with the values and mission of the Culver City Police Department and are expected of all department members. The standards contained in this policy are not intended to be an exhaustive list of requirements and prohibitions but they do identify many of the important matters concerning conduct. In addition to the provisions of this policy, members are subject to all other provisions contained in this manual, as well as any additional guidance on conduct that may be disseminated by this department or a member's supervisors.

322.2 POLICY

The continued employment or appointment of every member of the Culver City Police Department shall be based on conduct that reasonably conforms to the guidelines set forth herein. Failure to meet the guidelines set forth in this policy, whether on- or off-duty, may be cause for disciplinary action.

322.3 DIRECTIVES AND ORDERS

Members shall comply with lawful directives and orders from any department supervisor or person in a position of authority, absent a reasonable and bona fide justification.

322.3.1 UNLAWFUL OR CONFLICTING ORDERS

Supervisors shall not knowingly issue orders or directives that, if carried out, would result in a violation of any law or department policy. Supervisors should not issue orders that conflict with any previous order without making reasonable clarification that the new order is intended to countermand the earlier order.

No member is required to obey any order that appears to be in direct conflict with any federal law, state law or local ordinance. Following a known unlawful order is not a defense and does not relieve the member from criminal or civil prosecution or administrative discipline. If the legality of an order is in doubt, the affected member shall ask the issuing supervisor to clarify the order or shall confer with a higher authority. The responsibility for refusal to obey rests with the member, who shall subsequently be required to justify the refusal.

Unless it would jeopardize the safety of any individual, members who are presented with a lawful order that is in conflict with a previous lawful order, department policy or other directive shall respectfully inform the issuing supervisor of the conflict. The issuing supervisor is responsible for either resolving the conflict or clarifying that the lawful order is intended to countermand the previous lawful order or directive, in which case the member is obliged to comply. Members who are compelled to follow a conflicting lawful order after having given the issuing supervisor the opportunity to correct the conflict, will not be held accountable for disobedience of the lawful order or directive that was initially issued.

Culver City Police Department

Culver City PD Policy Manual

Standards of Conduct

The person countermanning the original order shall notify, in writing, the person issuing the original order, indicating the action taken and the reason.

322.3.2 SUPERVISOR RESPONSIBILITIES

Supervisors and managers are required to follow all policies and procedures and may be subject to discipline for:

- (a) Failure to be reasonably aware of the performance of their subordinates or to provide appropriate guidance and control.
- (b) Failure to promptly and fully report any known misconduct of a member to his/her immediate supervisor or to document such misconduct appropriately or as required by policy.
- (c) Directing a subordinate to violate a policy or directive, acquiesce to such a violation, or are indifferent to any such violation by a subordinate.
- (d) The unequal or disparate exercise of authority on the part of a supervisor toward any member for malicious or other improper purpose.

322.4 GENERAL STANDARDS

Members shall conduct themselves, whether on- or off-duty, in accordance with the United States and California constitutions and all applicable laws, ordinances, and rules enacted or established pursuant to legal authority.

Members shall familiarize themselves with policies and procedures and are responsible for compliance with each. Members should seek clarification and guidance from supervisors in the event of any perceived ambiguity or uncertainty.

Discipline may be initiated for any good cause. It is not mandatory that a specific policy or rule violation be cited to sustain discipline. This policy is not intended to cover every possible type of misconduct.

322.5 CAUSES FOR DISCIPLINE

The following are illustrative of causes for disciplinary action. This list is not intended to cover every possible type of misconduct and does not preclude the recommendation of disciplinary action for violation of other rules, standards, ethics and specific action or inaction that is detrimental to efficient department service:

322.5.1 LAWS, RULES AND ORDERS

- (a) Violation of, or ordering or instructing a subordinate to violate any policy, procedure, rule, order, directive, requirement or failure to follow instructions contained in department or City manuals.
- (b) Disobedience of any legal directive or order issued by any department member of a higher rank.
- (c) Violation of federal, state, local or administrative laws, rules or regulations.

Culver City Police Department

Culver City PD Policy Manual

Standards of Conduct

322.5.2 ETHICS

- (a) Using or disclosing one's status as a member of the Culver City Police Department in any way that could reasonably be perceived as an attempt to gain influence or authority for nondepartment business or activity.
- (b) The wrongful or unlawful exercise of authority on the part of any member for malicious purpose, personal gain, willful deceit or any other improper purpose.
- (c) The receipt or acceptance of a reward, fee or gift from any person for service incident to the performance of the member's duties (lawful subpoena fees and authorized work permits excepted).
- (d) Acceptance of fees, gifts or money contrary to the rules of this department and/or laws of the state.
- (e) Offer or acceptance of a bribe or gratuity.
- (f) Misappropriation or misuse of public funds, property, personnel or services.
- (g) Any other failure to abide by the standards of ethical conduct.

322.5.3 ATTENDANCE

- (a) Leaving the job to which the member is assigned during duty hours without reasonable excuse and proper permission and approval.
- (b) Unexcused or unauthorized absence or tardiness.
- (c) Excessive absenteeism or abuse of leave privileges.
- (d) Failure to report to work or to the place of assignment at the time specified and fully prepared to perform duties without reasonable excuse.

322.5.4 CONDUCT

- (a) Failure of any member to promptly and fully report activities on his/her part or the part of any other member where such activities resulted in contact with any other law enforcement agency or that may result in criminal prosecution or discipline under this policy.
- (b) Unreasonable and unwarranted force to a person encountered or a person under arrest.
- (c) Exceeding lawful peace officer powers by unreasonable, unlawful or excessive conduct.
- (d) Unauthorized or unlawful fighting, threatening or attempting to inflict unlawful bodily harm on another.
- (e) Engaging in horseplay that reasonably could result in injury or property damage.
- (f) Discourteous, disrespectful or discriminatory treatment of any member of the public or any member of this department or the City.
- (g) Use of obscene, indecent, profane or derogatory language while on duty or in uniform.

Culver City Police Department

Culver City PD Policy Manual

Standards of Conduct

1. However, in the interest of use of force prevention, nothing in this policy shall inhibit the use of such language when it becomes reasonable and necessary to establish command presence during encounters with:
 - (a) Immediate threats, such as an armed individual.
 - (b) Objectively hostile individuals who are resisting and/or ignoring lawful commands.
 - (c) Individuals who are physically combative and/or actively resisting arrest.
- (h) Criminal, dishonest, or disgraceful conduct, whether on- or off-duty, that adversely affects the member's relationship with this department.
- (i) Unauthorized possession of, loss of, or damage to department property or the property of others, or endangering it through carelessness or maliciousness.
- (j) Attempted or actual theft of department property; misappropriation or misuse of public funds, property, personnel or the services or property of others; unauthorized removal or possession of department property or the property of another person.
- (k) Activity that is incompatible with a member's conditions of employment or appointment as established by law or that violates a provision of any memorandum of understanding or contract to include fraud in securing the appointment or hire.
- (l) Initiating any civil action for recovery of any damages or injuries incurred in the course and scope of employment or appointment without first notifying the Chief of Police of such action.
- (m) Any other on or off duty conduct which any member knows or reasonably should know is unbecoming a member of this department, is contrary to good order, efficiency or morale, or tends to reflect unfavorably upon this department or its members.

322.5.5 PERFORMANCE

- (a) Failure to disclose or misrepresenting material facts, or making any false or misleading statement on any application, examination form, or other official document, report or form, or during the course of any workrelated investigation.
- (b) The falsification of any work-related records, making misleading entries or statements with the intent to deceive or the willful and unauthorized removal, alteration, destruction and/or mutilation of any department record, public record, book, paper or document.
- (c) Failure to participate in, or giving false or misleading statements, or misrepresenting or omitting material information to a supervisor or other person in a position of authority, in connection with any investigation or in the reporting of any department related business.
- (d) Being untruthful or knowingly making false, misleading or malicious statements that are reasonably calculated to harm the reputation, authority or official standing of this department or its members.
- (e) Disparaging remarks or conduct concerning duly constituted authority to the extent that such conduct disrupts the efficiency of this department or subverts the good order,

Culver City Police Department

Culver City PD Policy Manual

Standards of Conduct

efficiency and discipline of this department or that would tend to discredit any of its members.

- (f) Unlawful gambling or unlawful betting at any time or any place. Legal gambling or betting under any of the following conditions:
 - 1. While on department premises.
 - 2. At any work site, while on duty or while in uniform, or while using any department equipment or system.
 - 3. Gambling activity undertaken as part of an officer's official duties and with the express knowledge and permission of a direct supervisor is exempt from this prohibition.
- (g) Improper political activity including:
 - 1. Unauthorized attendance while on duty at official legislative or political sessions.
 - 2. Solicitations, speeches or distribution of campaign literature for or against any political candidate or position while on duty or, on department property except as expressly authorized by City policy, the memorandum of understanding, or the Chief of Police.
- (h) Engaging in political activities during assigned working hours except as expressly authorized by City policy, the memorandum of understanding, or the Chief of Police.
- (i) Any act on or off duty that brings discredit to this department.

322.5.6 DISCRIMINATION, OPPRESSION, OR FAVORITISM

Unless required by law or policy, discriminating against, oppressing, or providing favoritism to any person because of actual or perceived characteristics such as race, ethnicity, national origin, religion, sex, sexual orientation, gender identity or expression, age, disability, economic status, cultural group, veteran status, marital status, and any other classification or status protected by law, or intentionally denying or impeding another in the exercise or enjoyment of any right, privilege, power, or immunity, knowing the conduct is unlawful.

322.5.7 RELATIONSHIPS

- (a) Unwelcome solicitation of a personal or sexual relationship while on duty or through the use of one's official capacity.
- (b) Engaging in on-duty sexual activity, including but not limited to sexual intercourse, excessive displays of public affection, or other sexual contact.
- (c) Establishing or maintaining an inappropriate personal or financial relationship, as a result of an investigation, with a known victim, witness, suspect, or defendant while a case is being investigated or prosecuted, or as a direct result of any official contact.
- (d) Associating with or joining a criminal gang, organized crime, and/or criminal syndicate when the member knows or reasonably should know of the criminal nature of the organization. This includes any organization involved in a definable criminal activity or enterprise, except as specifically directed and authorized by this department.

Culver City Police Department

Culver City PD Policy Manual

Standards of Conduct

- (e) Associating on a personal, rather than official basis with persons who demonstrate recurring involvement in serious violations of state or federal laws after the member knows, or reasonably should know of such criminal activities, except as specifically directed and authorized by this department.
- (f) Participation in a law enforcement gang as defined by Penal Code § 13670. Participation is grounds for termination (Penal Code § 13670).

322.5.8 UNAUTHORIZED ACCESS, DISCLOSURE, OR USE

- (a) Unauthorized and inappropriate intentional release of confidential or protected information, materials, data, forms, or reports obtained as a result of the member's position with this department.
 - (a) Members of this department shall not disclose the name, address, or image of any victim of human trafficking except as authorized by law (Penal Code § 293).
- (b) Disclosing to any unauthorized person any active investigation information.
- (c) The use of any information, photograph, video, or other recording obtained or accessed as a result of employment or appointment to this department for personal or financial gain or without the express authorization of the Chief of Police or the authorized designee.
- (d) Loaning, selling, allowing unauthorized use, giving away, or appropriating any department property for personal use, personal gain, or any other improper or unauthorized use or purpose.
- (e) Using department resources in association with any portion of an independent civil action. These resources include but are not limited to personnel, vehicles, equipment, and nonsubpoenaed records.

322.5.9 EFFICIENCY

- (a) Neglect of duty.
- (b) Unsatisfactory work performance including but not limited to failure, incompetence, inefficiency, or delay in performing and/or carrying out proper orders, work assignments, or the instructions of supervisors without a reasonable and bona fide excuse.
- (c) Concealing, attempting to conceal, removing, or destroying defective or incompetent work.
- (d) Unauthorized sleeping during on-duty time or assignments.
- (e) Failure to notify the Department within 24 hours of any change in residence address or contact numbers.
- (f) Failure to notify the Personnel and Training of changes in relevant personal information (e.g., information associated with benefits determination) in a timely fashion.

Culver City Police Department

Culver City PD Policy Manual

Standards of Conduct

322.5.10 SAFETY

- (a) Failure to observe or violating department safety standards or safe working practices.
- (b) Failure to maintain current licenses or certifications required for the assignment or position (e.g., driver license, first aid).
- (c) Failure to maintain good physical condition sufficient to adequately and safely perform law enforcement duties.
- (d) Unsafe firearm or other dangerous weapon handling to include loading or unloading firearms in an unsafe manner, either on- or off- duty.
- (e) Carrying, while on the premises of the work place, any firearm or other lethal weapon that is not authorized by the member's appointing authority.
- (f) Unsafe or improper driving habits or actions in the course of employment or appointment.
- (g) Any personal action contributing to a preventable traffic collision.
- (h) Concealing or knowingly failing to report any on-the-job or work-related accident or injury as soon as practicable but within 24 hours.

322.5.11 INTOXICANTS

- (a) Reporting for work or being at work while intoxicated or when the member's ability to perform assigned duties is impaired due to the use of alcohol, medication or drugs, whether legal, prescribed or illegal.
- (b) Possession or use of alcohol at any work site or while on-duty, except as authorized in the performance of an official assignment. A member who is authorized to consume alcohol is not permitted to do so to such a degree that it may impair on-duty performance.
- (c) Unauthorized possession, use of, or attempting to bring a controlled substance, illegal drug or non-prescribed medication to any work site.

Information Technology Use

323.1 PURPOSE AND SCOPE

The purpose of this policy is to provide guidelines for the proper use of department information technology resources, including computers, electronic devices, hardware, software and systems.

323.1.1 DEFINITIONS

Definitions related to this policy include:

Computer system - All computers (on-site and portable), electronic devices, hardware, software, and resources owned, leased, rented or licensed by the Culver City Police Department that are provided for official use by its members. This includes all access to, and use of, Internet Service Providers (ISP) or other service providers provided by or through the Department or department funding.

Hardware - Includes, but is not limited to, computers, computer terminals, network equipment, electronic devices, telephones, including cellular and satellite, pagers, modems or any other tangible computer device generally understood to comprise hardware.

Software - Includes, but is not limited to, all computer programs, systems and applications, including shareware. This does not include files created by the individual user.

Temporary file, permanent file or file - Any electronic document, information or data residing or located, in whole or in part, on the system including, but not limited to, spreadsheets, calendar entries, appointments, tasks, notes, letters, reports, messages, photographs or videos.

323.2 POLICY

It is the policy of the Culver City Police Department that members shall use information technology resources, including computers, software and systems, that are issued or maintained by the Department in a professional manner and in accordance with this policy.

323.3 PRIVACY EXPECTATION

Members forfeit any expectation of privacy with regard to emails, texts, or anything published, shared, transmitted, or maintained through file-sharing software or any internet site that is accessed, transmitted, received, or reviewed on any department computer system.

The Department reserves the right to access, audit, and disclose, for whatever reason, any message, including attachments, and any information accessed, transmitted, received, or reviewed over any technology that is issued or maintained by the Department, including the department email system, computer network, and/or any information placed into storage on any department system or device. This includes records of all keystrokes or Web-browsing history made at any department computer or over any department network. The fact that access to a database, service, or website requires a username or password will not create an expectation of privacy if it is accessed through department computers, electronic devices, or networks.

Culver City Police Department

Culver City PD Policy Manual

Information Technology Use

The Department shall not require a member to disclose a personal username or password for accessing personal social media or to open a personal social website; however, the Department may request access when it is reasonably believed to be relevant to the investigation of allegations of work-related misconduct (Labor Code § 980).

323.4 RESTRICTED USE

Members shall not access computers, devices, software or systems for which they have not received prior authorization or the required training. Members shall immediately report unauthorized access or use of computers, devices, software or systems by another member to their supervisors or Watch Commanders.

Members shall not use another person's access passwords, logon information and other individual security data, protocols and procedures unless directed to do so by a supervisor.

323.4.1 SOFTWARE

Members shall not copy or duplicate any copyrighted or licensed software except for a single copy for backup purposes in accordance with the software company's copyright and license agreement.

To reduce the risk of a computer virus or malicious software, members shall not install any unlicensed or unauthorized software on any department computer. Members shall not install personal copies of any software onto any department computer.

When related to criminal investigations, software program files may be downloaded only with the approval of the information systems technology (IT) staff and with the authorization of the Chief of Police or the authorized designee.

No member shall knowingly make, acquire or use unauthorized copies of computer software that is not licensed to the Department while on department premises, computer systems or electronic devices. Such unauthorized use of software exposes the Department and involved members to severe civil and criminal penalties.

Introduction of software by members should only occur as part of the automated maintenance or update process of department- or City-approved or installed programs by the original manufacturer, producer or developer of the software.

Any other introduction of software requires prior authorization from IT staff and a full scan for malicious attachments.

323.4.2 HARDWARE

Access to technology resources provided by or through the Department shall be strictly limited to department-related activities. Data stored on or available through department computer systems shall only be accessed by authorized members who are engaged in an active investigation or assisting in an active investigation, or who otherwise have a legitimate law enforcement or department-related purpose to access such data. Any exceptions to this policy must be approved by a supervisor.

Culver City Police Department

Culver City PD Policy Manual

Information Technology Use

323.4.3 INTERNET USE

Internet access provided by or through the Department shall be strictly limited to department-related activities. Internet sites containing information that is not appropriate or applicable to department use and which shall not be intentionally accessed include but are not limited to adult forums, pornography, gambling, chat rooms, and similar or related internet sites. Certain exceptions may be permitted with the express approval of a supervisor as a function of a member's assignment.

Downloaded information shall be limited to messages, mail, and data files.

323.5 PROTECTION OF AGENCY SYSTEMS AND FILES

All members have a duty to protect the computer system and related systems and devices from physical and environmental damage and are responsible for the correct use, operation, care, and maintenance of the computer system.

Members shall ensure department computers and access terminals are not viewable by persons who are not authorized users. Computers and terminals should be secured, users logged off and password protections enabled whenever the user is not present. Access passwords, logon information, and other individual security data, protocols, and procedures are confidential information and are not to be shared. Password length, format, structure, and content shall meet the prescribed standards required by the computer system or as directed by a supervisor and shall be changed at intervals as directed by IT staff or a supervisor.

It is prohibited for a member to allow an unauthorized user to access the computer system at any time or for any reason. Members shall promptly report any unauthorized access to the computer system or suspected intrusion from outside sources (including the internet) to a supervisor.

323.6 INSPECTION OR REVIEW

A supervisor or the authorized designee has the express authority to inspect or review the computer system, all temporary or permanent files, related electronic systems or devices, and any contents thereof, whether such inspection or review is in the ordinary course of his/her supervisory duties or based on cause.

Reasons for inspection or review may include, but are not limited to, computer system malfunctions, problems or general computer system failure, a lawsuit against the Department involving one of its members or a member's duties, an alleged or suspected violation of any department policy, a request for disclosure of data, or a need to perform or provide a service.

The IT staff may extract, download or otherwise obtain any and all temporary or permanent files residing or located in or on the department computer system when requested by a supervisor or during the course of regular duties that require such information.

Report Preparation

324.1 PURPOSE AND SCOPE

Report preparation is a major part of each officer's job. The purpose of reports is to document sufficient information to refresh the officer's memory and to provide sufficient information for follow-up investigation and successful prosecution. Report writing is the subject of substantial formalized training and on-the-job training.

324.1.1 REPORT PREPARATION

Employees should ensure that reports are sufficiently detailed for their purpose and free from errors prior to submission. It is the responsibility of the assigned employee to complete and submit all reports taken during the shift before going off-duty unless permission to hold the report has been approved by a supervisor. Generally, reports requiring prompt follow-up action on active leads, or arrest reports where the suspect remains in custody should not be held.

Handwritten reports must be prepared legibly. If the report is not legible, the submitting employee will be required by the reviewing supervisor to promptly make corrections and resubmit the report. Employees who dictate reports shall use appropriate grammar, as content is not the responsibility of the typist. Employees who generate reports on computers are subject to all requirements of this policy.

All reports shall accurately reflect the identity of the persons involved, all pertinent information seen, heard or assimilated by any other sense, and any actions taken. Employees shall not suppress, conceal or distort the facts of any reported incident, nor shall any employee make a false report orally or in writing. Generally, the reporting employee's opinions should not be included in reports unless specifically identified as such.

324.2 REQUIRED REPORTING

Written reports are required in all of the following situations on the appropriate department approved form unless otherwise approved by a supervisor.

324.2.1 CRIMINAL ACTIVITY

When a member responds to a call for service, or as a result of self-initiated activity becomes aware of any activity where a crime has occurred, the member shall document the incident regardless of whether a victim desires prosecution. Activity to be documented in a written report includes:

- (a) All arrests
- (b) All felony crimes
- (c) Non-Felony incidents involving threats or stalking behavior
- (d) Situations covered by separate policy. These include:
 1. Use of Force Policy
 2. Domestic Violence Policy

Culver City Police Department

Culver City PD Policy Manual

Report Preparation

3. Child Abuse Policy
4. Senior and Disability Victimization Policy
5. Hate Crimes Policy
6. Suspicious Activity Reporting Policy

- (e) All misdemeanor crimes where the victim desires a report

Misdemeanor crimes where the victim does not desire a report shall be documented using the department-approved alternative reporting method (e.g., dispatch log).

324.2.2 NON-CRIMINAL ACTIVITY

The following incidents shall be documented using the appropriate approved report:

- (a) Any use of force against any person by a member of this department (see the Use of Force Policy)
- (b) Any firearm discharge (see the Firearms Policy)
- (c) Anytime a person is reported missing, regardless of jurisdiction (see the Missing Persons Policy)
- (d) Any found property or found evidence
- (e) Any traffic collisions above the minimum reporting level (see Traffic Collision Reporting Policy)
- (f) Suspicious incidents that may indicate a potential for crimes against children or that a child's safety is in jeopardy
- (g) All protective custody detentions
- (h) Suspicious incidents that may place the public or others at risk
- (i) Whenever the employee believes the circumstances should be documented or at the direction of a supervisor

324.2.3 DEATH CASES

Death investigations require specific investigation methods depending on circumstances and should be handled in accordance with the Death Investigations Policy. The handling officer should notify and apprise a supervisor of the circumstances surrounding the incident to determine how to proceed. The following cases shall be appropriately investigated and documented using the approved report:

- (a) Sudden or accidental deaths.
- (b) Suicides.
- (c) Homicide or suspected homicide.

Culver City Police Department

Culver City PD Policy Manual

Report Preparation

- (d) Unattended deaths (No physician or qualified hospice care in the 20 days preceding death).
- (e) Found dead bodies or body parts.

324.2.4 INJURY OR DAMAGE BY CITY PERSONNEL

Reports shall be taken if an injury occurs that is a result of an act of a City employee. Additionally, reports shall be taken involving damage to City property or City equipment.

324.2.5 MISCELLANEOUS INJURIES

Any injury that is reported to this department shall require a report when:

- (a) The injury is a result of drug overdose
- (b) Attempted suicide
- (c) The injury is major/serious, whereas death could result
- (d) The circumstances surrounding the incident are suspicious in nature and it is desirable to record the event

The above reporting requirements are not intended to be all-inclusive. A supervisor may direct an employee to document any incident he/she deems necessary.

324.2.6 MANDATORY REPORTING OF JUVENILE GUNSHOT INJURIES

A report shall be taken when any incident in which a child 18 years or younger suffered an unintentional or self-inflicted gunshot wound. The Records Section shall notify the California Department of Public Health (CDPH) of the incident as required by CDPH (Penal Code § 23685).

324.3 GENERAL POLICY OF EXPEDITIOUS REPORTING

In general, all officers and supervisors shall act with promptness and efficiency in the preparation and processing of all reports. An incomplete report, unorganized reports or reports delayed without supervisory approval are not acceptable. Reports shall be processed according to established priorities or according to special priority necessary under exceptional circumstances.

324.3.1 GENERAL POLICY OF HANDWRITTEN REPORTS

Some incidents and report forms lend themselves to block print rather than typing. In general, the narrative portion of those reports where an arrest is made or when there is a long narrative should be typed or dictated.

Supervisors may require, with the foregoing general policy in mind, block printing or typing of reports of any nature for department consistency.

324.3.2 GENERAL USE OF OTHER HANDWRITTEN FORMS

County, state and federal agency forms may be block printed as appropriate. In general, the form itself may make the requirement for typing apparent.

Culver City Police Department

Culver City PD Policy Manual

Report Preparation

324.4 REPORT CORRECTIONS

Supervisors shall review reports for content and accuracy. If a correction is necessary, the reviewing supervisor should complete the Report Correction form stating the reasons for rejection. The original report and the correction form should be returned to the reporting employee for correction as soon as practical. It shall be the responsibility of the originating officer to ensure that any report returned for correction is processed in a timely manner.

324.5 REPORT CHANGES OR ALTERATIONS

Reports that have been approved by a supervisor and submitted to the Records Section for filing and distribution shall not be modified or altered except by way of a supplemental report. Reviewed reports that have not yet been submitted to the Records Section may be corrected or modified by the authoring officer only with the knowledge and authorization of the reviewing supervisor.

Media Relations

325.1 PURPOSE AND SCOPE

This policy provides guidelines for the release of official department information to the media. It also addresses coordinating media access to scenes of disasters, criminal investigations, emergencies, and other law enforcement activities.

325.2 RESPONSIBILITIES

The ultimate authority and responsibility for the release of information to the media shall remain with the Chief of Police. In situations not warranting immediate notice to the Chief of Police and in situations where the Chief of Police has given prior approval, Bureau Commanders, Watch Commanders, and designated Public Information Officers (PIOs) may prepare and release information to the media in accordance with this policy and the applicable laws regarding confidentiality.

325.2.1 MEDIA REQUEST

Any media request for information or access to a law enforcement situation shall be referred to the designated department media representative, or if unavailable, to the first available supervisor. Prior to releasing any information to the media, employees shall consider the following:

- (a) At no time shall any employee of this department make any comment or release any official information to the media without prior approval from a supervisor or the designated department media representative.
- (b) In situations involving multiple law enforcement agencies, every reasonable effort should be made to coordinate media releases with the authorized representative of each involved agency prior to the release of any information by this department.
- (c) Under no circumstance should any member of this department make any comments to the media regarding any law enforcement incident not involving this department without prior approval of the Chief of Police.

325.3 ACCESS

Authorized media representatives shall be provided access to scenes of disasters, criminal investigations, emergencies, and other law enforcement activities as required by law.

Access by the media is subject to the following conditions (Penal Code § 409.5(d)):

- (a) The media representative shall produce valid press credentials that shall be prominently displayed at all times while in areas otherwise closed to the public. Media representatives may not bring or facilitate the transport of an unauthorized person into a closed area unless it is for the safety of the person.
- (b) Media representatives may be prevented from interfering with emergency operations and criminal investigations.

Culver City Police Department

Culver City PD Policy Manual

Media Relations

1. Based upon available resources, reasonable effort should be made to provide a safe staging area for the media that is near the incident and that will not interfere with emergency or criminal investigation operations. All information released to the media should be coordinated through the PIO or other designated spokesperson.
- (c) No member of this department who is under investigation shall be subjected to media visits or interviews without the consent of the involved member (Government Code § 3303(e)).
- (d) Media interviews with individuals who are in custody should not be permitted without the approval of the Chief of Police and the express consent of the person in custody.

325.3.1 PROVIDING ADVANCE INFORMATION

To protect the safety and rights of officers and other persons, advance information about planned actions by law enforcement personnel, such as movement of persons in custody or the execution of an arrest or search warrant, should not be disclosed to the news media, nor should media representatives be invited to be present at such actions except with the prior approval of the Chief of Police.

Any exceptions to the above should only be considered for the furtherance of legitimate law enforcement purposes. Prior to approving any exception the Chief of Police will consider, at minimum, whether the release of information or presence of the media would unreasonably endanger any individual, prejudice the rights of any person or is otherwise prohibited by law.

325.3.2 CRITICAL OPERATIONS

A critical incident or tactical operation should be handled in the same manner as a crime scene, except the media should not be permitted within the inner perimeter of the incident, subject to any restrictions as determined by the supervisor in charge. Department members shall not jeopardize a critical incident or tactical operation in order to accommodate the media. All comments to the media shall be coordinated through a supervisor or the PIO.

325.3.3 TEMPORARY FLIGHT RESTRICTIONS

Whenever the presence of media or other aircraft pose a threat to public or member safety or significantly hamper incident operations, the field supervisor should consider requesting a Temporary Flight Restriction (TFR). All requests for a TFR should be routed through the Watch Commander. The TFR request should include specific information regarding the perimeter and altitude necessary for the incident and should be requested through the appropriate control tower. If the control tower is not known, the Federal Aviation Administration (FAA) should be contacted (14 CFR 91.137).

325.4 POLICY

It is the policy of the Culver City Police Department to protect the privacy rights of individuals, while releasing non-confidential information to the media regarding topics of public concern. Information that has the potential to negatively affect investigations will not be released.

Culver City Police Department

Culver City PD Policy Manual

Media Relations

325.5 PROVIDING ADVANCE INFORMATION

To protect the safety and rights of department members and other persons, advance information about planned actions by law enforcement personnel, such as movement of persons in custody or the execution of an arrest or search warrant, should not be disclosed to the media, nor should media representatives be invited to be present at such actions except with the prior approval of the Chief of Police.

Any exceptions to the above should only be considered for the furtherance of legitimate law enforcement purposes. Prior to approving any exception, the Chief of Police will consider, at a minimum, whether the release of information or presence of the media would unreasonably endanger any individual, prejudice the rights of any person, or is otherwise prohibited by law.

325.6 MEDIA REQUESTS

Any media request for information or access to a law enforcement incident shall be referred to the PIO, or if unavailable, to the first available supervisor. Prior to releasing any information to the media, members shall consider the following:

- (a) At no time shall any member of this department make any comment or release any official information to the media without prior approval from a supervisor or the PIO.
- (b) In situations involving multiple agencies or government departments, every reasonable effort should be made to coordinate media releases with the authorized representative of each involved agency prior to the release of any information by this department.
- (c) Under no circumstance should any member of this department make any comments to the media regarding any law enforcement incident not involving this department without prior approval of the Chief of Police. Under these circumstances the member should direct the media to the agency handling the incident.

325.7 CONFIDENTIAL OR RESTRICTED INFORMATION

It shall be the responsibility of the PIO to ensure that confidential or restricted information is not inappropriately released to the media (see the Records Maintenance and Release and Personnel Records policies). When in doubt, authorized and available legal counsel should be consulted prior to releasing any information.

325.7.1 EMPLOYEE INFORMATION

The identities of officers involved in shootings or other critical incidents may only be released to the media upon the consent of the involved officer or upon a formal request filed.

Any requests for copies of related reports or additional information not contained in the information log (see the Information Log section in this policy), including the identity of officers involved in shootings or other critical incidents, shall be referred to the PIO.

Requests should be reviewed and fulfilled by the Custodian of Records, or if unavailable, the Watch Commander or the authorized designee. Such requests will be processed in accordance with the provisions of the Records Maintenance and Release Policy and public records laws.

Culver City Police Department

Culver City PD Policy Manual

Media Relations

325.8 RELEASE OF INFORMATION

The Department may routinely release information to the media without receiving a specific request. This may include media releases regarding critical incidents, information of public concern, updates regarding significant incidents, or requests for public assistance in solving crimes or identifying suspects. This information may also be released through the department website or other electronic data sources.

325.8.1 INFORMATION LOG

The Department will maintain a daily information log of significant law enforcement activities. Log entries shall only contain information that is deemed public information and not restricted or confidential by this policy or applicable law. Upon request, the log entries shall be made available to media representatives through the Watch Commander.

The daily information log will generally include:

- (a) The date, time, location, case number, type of crime, extent of injury or loss, and names of individuals involved in crimes occurring within this jurisdiction, unless the release of such information would endanger the safety of any individual or jeopardize the successful completion of any ongoing investigation, or the information is confidential (e.g., juveniles or certain victims).
- (b) The date, time, location, case number, name, birth date, and charges for each person arrested by this department, unless the release of such information would endanger the safety of any individual or jeopardize the successful completion of any ongoing investigation or the information is confidential (e.g., juveniles).
- (c) The time and location of other significant law enforcement activities or requests for service with a brief summary of the incident.

At no time shall identifying information pertaining to a juvenile arrestee (13 years of age and under), victim, or witness be publicly released without prior approval of a competent court. The identity of a minor 14 years of age or older shall not be publicly disclosed unless the minor has been arrested for a serious felony and the release of such information has been approved by the Watch Commander (Welfare and Institutions Code § 827.5).

Identifying information concerning deceased individuals shall not be released to the media until notification of next of kin or otherwise cleared through the Coroner.

Any requests for copies of related reports or additional information not contained in this log shall be referred to the designated department media representative, the custodian of records, or if unavailable, to the Watch Commander. Such requests will generally be processed in accordance with the provisions of the Public Records Act (see the Records Maintenance and Release Policy).

Subpoenas and Court Appearances

326.1 PURPOSE AND SCOPE

This policy establishes the guidelines for department members who must appear in court. It will allow the Culver City Police Department to cover any related work absences and keep the Department informed about relevant legal matters.

326.2 POLICY

Culver City Police Department members will respond appropriately to all subpoenas and any other court-ordered appearances.

326.3 SUBPOENAS

326.3.1 ELECTRONIC MAIL SUBPOENAS

The issuance of criminal court subpoenas to members of the department is administered electronically by the Los Angeles County District Attorney's Office and the department's authorized vendor (currently "Webiplex eSubpoena System"). The "eSubpoenas" are delivered to department members via the Culver City electronic mail server. "eSubpoena" is the department's primary means of receiving and delivery of officer subpoenas.

Members receive training in the "Webiplex eSubpoena System" from the investigator assigned to the department's District Attorney Liaison desk.

326.3.2 OTHER SUBPOENAS

Only department members authorized to receive a subpoena on behalf of this department or any of its members may do so. This may be accomplished by personal service to the member, U.S. Mail delivery, or by delivery of two copies of the subpoena to the member's supervisor or other authorized departmental agent (Government Code § 68097.1; Penal Code § 1328(c)).

The party that issues a civil subpoena to testify as a witness must tender the statutory fee of \$275 with the subpoena for each day that an appearance is required before service is accepted of the subpoena (Government Code § 68097.2).

An immediate supervisor or authorized individual may refuse to accept service for a criminal subpoena if (Penal Code § 1328(d)(e)):

- (a) He/she knows that he/she will be unable to deliver a copy of the subpoena to the named within sufficient time for the named to comply with the subpoena.
- (b) It is less than five working days prior to the date listed for an appearance and he/she is not reasonably certain that service can be completed.

If, after initially accepting service of a criminal subpoena, a supervisor or other authorized individual determines that he/she is unable to deliver a copy of the subpoena to the named within sufficient time for the named to comply with the subpoena, the supervisor or the subpoena clerk shall notify the server or the attorney named on the subpoena of such not less than 48 hours prior to the date listed for the appearance (Penal Code § 1328(f)).

Culver City Police Department

Culver City PD Policy Manual

Subpoenas and Court Appearances

326.3.3 SPECIAL NOTIFICATION REQUIREMENTS

Any member who is subpoenaed to testify, agrees to testify or provides information on behalf of or at the request of any party other than the City Attorney or the prosecutor shall notify his/her immediate supervisor without delay regarding:

- (a) Any civil case where the City or one of its members, as a result of his/her official capacity, is a party.
- (b) Any civil case where any other city, county, state or federal unit of government or a member of any such unit of government, as a result of his/her official capacity, is a party.
- (c) Any criminal proceeding where the member is called to testify or provide information on behalf of the defense.
- (d) Any civil action stemming from the member's on-duty activity or because of his/her association with the Culver City Police Department.
- (e) Any personnel or disciplinary matter when called to testify or to provide information by a government entity other than the Culver City Police Department.

The supervisor will then notify the Chief of Police and the appropriate prosecuting attorney as may be indicated by the case. The Chief of Police should determine if additional legal support is necessary.

No member shall be retaliated against for testifying in any matter.

326.3.4 CIVIL SUBPOENA

The Department will compensate members who appear in their official capacities on civil matters arising out of their official duties, as directed by the current memorandum of understanding or collective bargaining agreement.

The Department should seek reimbursement for the member's compensation through the civil attorney of record who subpoenaed the member. The party that issues a civil subpoena to an officer to testify as a witness must tender the statutory fee of \$275 with the subpoena for each day that an appearance is required before service is accepted of the subpoena (Government Code § 68097.2).

326.3.5 OFF-DUTY RELATED SUBPOENAS

Members receiving valid subpoenas for off-duty actions not related to their employment or appointment will not be compensated for their appearance. Arrangements for time off shall be coordinated through their immediate supervisors.

326.4 FAILURE TO APPEAR

Any member who fails to comply with the terms of any properly served subpoena or court-ordered appearance may be subject to discipline. This includes properly served orders to appear that were issued by a state administrative agency.

Culver City Police Department

Culver City PD Policy Manual

Subpoenas and Court Appearances

326.5 STANDBY

To facilitate standby agreements, members are required to provide and maintain current information on their addresses and contact telephone numbers with the Department.

If a member on standby changes his/her location during the day, the member shall notify the designated department member of how he/she can be reached. Members are required to remain on standby until released by the court or the party that issued the subpoena.

326.6 COURTROOM PROTOCOL

When appearing in court, members shall:

- (a) Be punctual and prepared to proceed immediately with the case for which they are scheduled to appear.
- (b) Dress in the department uniform or business attire.
- (c) Observe all rules of the court in which they are appearing and remain alert to changes in the assigned courtroom where their matter is to be heard.

326.6.1 TESTIMONY

Before the date of testifying, the subpoenaed member shall request a copy of relevant reports and become familiar with the content in order to be prepared for court.

326.7 OVERTIME APPEARANCES

When a member appears in court on his/her off-duty time, he/she will be compensated in accordance with the current memorandum of understanding or collective bargaining agreement.

Reserve Officers

327.1 PURPOSE AND SCOPE

The Culver City Police Department Reserve Unit was established to supplement and assist regular sworn police officers and professional staff in their duties. This unit provides professional, sworn volunteer reserve officers who can augment department staffing levels. These officers work under the supervision of regular full-time officers and professional staff to provide law enforcement services to the community.

327.2 SELECTION AND APPOINTMENT OF POLICE RESERVE OFFICERS

The Culver City Police Department shall endeavor to recruit and appoint to the Reserve Unit only those applicants who meet the high ethical, moral and professional standards set forth by this department. Reserve peace officers are required by California POST regulations to meet the same selection standards and pre-employment procedures (e.g. personal history investigation and medical and psychological screening) as full-time regular officers.

Before appointment to the Police Reserve Unit, an applicant must have completed, or be in the process of completing, a POST approved basic academy or extended basic academy.

327.2.1 RESERVE OFFICER LEVELS (I, II, III)

The Legislature has established three levels of reserve peace officer to provide flexibility to law enforcement agencies. The duties of the different levels of reserve officer are described below:

- **Level III**
 - Level III Penal Code sections [830.6\(a\) \(1\)](#) and [832.6\(a\) \(3\)](#)
 - Level III reserve officers may perform specified limited support duties, and other duties that are not likely to result in physical arrests, while supervised in the accessible vicinity by a Level I reserve officer or a full-time regular officer. Additionally, Level III reserve officers may transport prisoners without immediate supervision.
- **Level II**
 - Level II Penal Code sections [830.6\(a\) \(1\)](#) and [832.6\(a\) \(2\)](#)
 - Level II reserve officers may perform general law enforcement assignments while under the immediate supervision of a peace officer who has completed the Regular Basic Course.
 - These officers may also work assignments authorized for Level III reserve officers without immediate supervision.
- **Level I**
 - Level I Penal Code sections [830.6\(a\) \(1\)](#) and [832.6\(a\) \(1\)](#)
 - Level I reserve officers may work alone and perform the same duties as full-time regular officers.

Culver City Police Department

Culver City PD Policy Manual

Reserve Officers

For a quick view of appointment levels, description of authority, assignment, supervision and training, please refer to the [Reserve Peace Officer Status Summary Table](#) (doc).

327.2.2 PROCEDURE

All Level I and Level II applicants shall be required to meet and pass the same pre-employment procedures as regular full-time police officers before appointment.

Before appointment to the Police Reserve Unit, all Level I and Level II applicants must have completed, or be in the process of completing, a POST approved basic academy or extended basic academy.

All Level III reserve officer applicants shall be required to pass a written exam, oral interview, polygraph examination, background examination, and Chief's Interview.

A Level III reserve officer shall not be allowed to carry a firearm while on or off duty unless he/she passes the Department's physical agility test and after that the decision to allow a Level III to carry a firearm will at the discretion of the Administration Bureau Commander.

327.2.3 APPOINTMENT

Applicants who are selected for appointment to the Police Reserve Unit shall, on the recommendation of the Chief of Police, be sworn in by the Chief of Police and take a loyalty oath to observe and obey all of the laws of the land and to carry out their duties to the best of their ability.

327.2.4 COMPENSATION FOR POLICE RESERVE OFFICERS

Compensation for reserve officers is provided as follows:

Reserve Officers are strictly volunteer employees and shall not be monetarily compensated in any way for their services.

All reserve officer appointees are issued designated safety equipment. All property issued to the reserve officer shall be returned to the Department upon termination or resignation.

Reserve Officers who are designated to wear uniforms may receive reimbursement for uniform purchases only after submitting an Interdepartmental Memorandum (IDC) along with receipts, to the Reserve Unit Coordinator, explaining what they are requesting to be reimbursed for and the reason for making the purchase.

327.2.5 EMPLOYEES WORKING AS RESERVE OFFICERS

Qualified employees of this department, when authorized, may also serve as reserve officers. However, the Department must not utilize the services of a reserve or volunteer in such a way that it would violate employment laws or labor agreements (e.g., a detention officer working as a reserve officer for reduced or no pay). Therefore, the Reserve Coordinator should consult the Personnel and Training prior to an employee serving in a reserve or volunteer capacity (29 CFR 553.30).

Culver City Police Department

Culver City PD Policy Manual

Reserve Officers

327.3 DUTIES OF RESERVE OFFICERS

Level I and Level II Reserve officers assist regular officers in the enforcement of laws and in maintaining peace and order within the community. Assignments of Level 1 and Level II reserve officers will usually be to augment the Operations Bureau. Reserve officers may be assigned to other areas within the Department as needed.

All reserve officers are required to work a minimum of 20 hours, and attend a four hour meeting per month.

327.3.1 POLICY COMPLIANCE

Police reserve officers shall be required to adhere to all departmental policies and procedures. Online access (Lexipol) of the policies and procedures will be made available to each reserve officer upon appointment and he/she shall become thoroughly familiar with these policies.

Whenever a rule, regulation, or guideline in this manual refers to a sworn regular full-time officer, it shall also apply to a sworn reserve officer unless by its nature it is inapplicable.

327.3.2 RESERVE OFFICER ASSIGNMENTS

All reserve officers will be assigned to duties by the Reserve Coordinator or his/her designee.

327.3.3 RESERVE COORDINATOR

The Chief of Police shall delegate the responsibility for administering the Reserve Officer Program to a Reserve Coordinator.

The Reserve Coordinator shall have the responsibility of, but not be limited to:

- (a) Assignment of reserve personnel
- (b) Conducting reserve meetings
- (c) Establishing and maintaining a reserve call-out roster
- (d) Maintaining and ensuring performance evaluations are completed
- (e) Monitoring individual reserve officer performance
- (f) Monitoring overall Reserve Program
- (g) Maintaining liaison with other agency Reserve Coordinators
- (h) Provide training on law enforcement related topics at the monthly meeting.

327.4 FIELD TRAINING

The Commission on Peace Officer Standards and Training (POST) sets training standards for all peace officers in California.

- Designated Level I Reserve Officers must satisfactorily complete the POST Basic Course which is the same training required of full-time officers (Level I Academy plus field training).
- Level II Reserve Officers are required to satisfactorily complete the prescribed Level II course of instruction.

Culver City Police Department

Culver City PD Policy Manual

Reserve Officers

- Level III Reserve Officers are required to satisfactorily complete the prescribed Level III training program.

327.4.1 TRAINING OFFICERS

Field Training Officers of this department, who demonstrate a desire and ability to train reserve officers, may train the reserves during Phase II, subject to Field Training Program Manager's approval.

327.4.2 PRIMARY TRAINING OFFICER

Upon completion of the Academy, reserve officers will be assigned to a primary training officer. The primary training officer will be selected from members of the Field Training Officer (FTO) Committee. The reserve officer will be assigned to work with his/her primary training officer during the first 160 hours of training. This time shall be known as the Primary Training Phase.

327.4.3 FIELD TRAINING MANUAL

Each new Level I or Level II reserve officer will be given access to the online Field Training Manual at the beginning of his/her Primary Training Phase. This manual is an outline of the subject matter and/or skills necessary to properly function as an officer with the Culver City Police Department. The reserve officer shall become knowledgeable of the subject matter as outlined. He/she shall also become proficient with those skills as set forth in the manual.

327.4.4 COMPLETION OF THE PRIMARY TRAINING PHASE

At the completion of the Primary Training Phase, (Phase I) the primary training officer will meet with the Reserve Coordinator. The purpose of this meeting is to discuss the progress of the Level I or Level II reserve officer in training.

If the reserve officer has progressed satisfactorily, he/she will then proceed to Phase II of the training. If he/she has not progressed satisfactorily, the Reserve Coordinator will determine the appropriate action to be taken.

327.4.5 SECONDARY TRAINING PHASE

The Secondary Training Phase (Phase II) shall consist of 100 hours of additional on-duty training. The Level I or Level II reserve officer will no longer be required to ride with his/her primary training officer. The reserve officer may now ride with any officer designated by the Watch Commander.

During Phase II of training, as with Phase I, the reserve officer's performance will be closely monitored. In addition, rapid progress should continue towards the completion of the Officer's Field Training Manual. At the completion of Phase II of training, the reserve officer will return to his/her primary training officer for Phase III of the training.

327.4.6 THIRD TRAINING PHASE

Phase III of training shall consist of 24 hours of additional on-duty training. For this training phase, the reserve officer will return to his/her original primary training officer. During this phase, the training officer will evaluate the reserve officer for suitability to graduate from the formal training program.

Culver City Police Department

Culver City PD Policy Manual

Reserve Officers

At the completion of Phase III training, the primary training officer will meet with the Reserve Coordinator. Based upon the reserve officer's evaluations, plus input from the primary training officer, the Reserve Coordinator shall decide if the reserve officer has satisfactorily completed his/her formal training. If the reserve officer has progressed satisfactorily, he/she will then graduate from the formal training process. If his/her progress is not satisfactory, the Reserve Coordinator will decide upon the appropriate action to be taken.

327.4.7 COMPLETION OF THE FORMAL TRAINING PROCESS

When a Level I and Level II Reserve Officer has satisfactorily completed all three phases of formal training, he/she will have had a minimum of 284 hours of on-duty training. He/she will no longer be required to ride with a reserve training officer. The reserve officer may now be assigned to ride with any officer for the remaining 200-hour requirement for a total of 484 hours before being considered for relief of immediate supervision.

327.5 SUPERVISION OF RESERVE OFFICERS

Reserve officers who have attained the status of Level II shall be under the immediate supervision of a regular sworn officer (Penal Code 832.6). The immediate supervision requirement shall also continue for reserve officers who have attained Level I status unless special authorization is received from the Reserve Coordinator with the approval of the Bureau Commander.

327.5.1 SPECIAL AUTHORIZATION REQUIREMENTS

Reserve officers certified as Level I may, with prior authorization of the Reserve Coordinator and on approval of the Administration Bureau Commander, be relieved of the "immediate supervision" requirement. Level I reserve officers may function under the authority of Penal Code § 832.6(a) (1) only for the duration of the assignment or purpose for which the authorization was granted.

In the absence of the Reserve Coordinator and the Bureau Commander, the Watch Commander may assign a certified Level I reserve officer to function under the authority of Penal Code § 832.6(a)(1) for specific purposes and duration.

327.5.2 RESERVE OFFICER MEETINGS

All reserve officer meetings will be scheduled and conducted by the Reserve Coordinator. All reserve officers are required to attend scheduled meetings monthly. Any absences must be satisfactorily explained to the Reserve Coordinator.

327.5.3 IDENTIFICATION OF RESERVE OFFICERS

All Level I and Level II reserve officers will be issued a uniform badge, flat badge, and a Department identification card. Level III reserve officers will be issued a flat badge and a Department identification card. The uniform badge and the flat badge shall be the same as that worn by a regular full-time officer, with the exception that the reserve officer's badge number shall begin with the number "9.". The identification card will be the standard identification card with the exception that "Reserve" will be indicated on the card.

Culver City Police Department

Culver City PD Policy Manual

Reserve Officers

327.5.4 UNIFORM

Reserve officers shall conform to all uniform regulation and appearance standards of this department.

327.5.5 INVESTIGATIONS AND COMPLAINTS

If a reserve officer has a complaint made against him/her or becomes involved in an internal investigation, that complaint or internal investigation may be investigated by the Professional Standards Unit or the Reserve Coordinator.

Reserve officers are considered volunteer, at-will employees. Government Code § 3300 et seq. applies to reserve officers with the exception that the right to a hearing is limited to the opportunity to clear their name.

Any disciplinary action that may have to be administered to a reserve officer shall be accomplished as outlined in the Policy Manual.

327.5.6 RESERVE OFFICER EVALUATIONS

While in training, reserve officers will be continuously evaluated using standardized daily and weekly observation reports. The reserve officer will be considered a trainee until all of the training phases have been completed. Reserve officers having completed their field training will be evaluated annually using performance dimensions applicable to the duties and authorities granted to that reserve.

327.5.7 SUSPENSION FROM SERVICE

When an incident involving a Reserve Officer is of a nature warranting such action, the officer may be temporarily suspended from the Section. The period of the suspension shall be determined by the nature of the incident. The decision on whether or not a Reserve officer should be suspended from the Section shall be that of the Bureau Commander and upon approval of the Chief of Police.

327.5.8 REMOVAL FROM MEMBERSHIP

A Reserve Officer may be removed from the Reserve Program by the Administration Bureau Commander based upon the recommendation of the Reserve Coordinator and or the Personnel and Training Lieutenant.

A Reserve Officer's course of appeal shall be the Chief of Police. Such appeal shall be made within ten (10) calendar days of the disciplinary action.

327.6 FIREARMS REQUIREMENTS

Penal Code § 830.6(a)(1) designates a reserve officer as having peace officer powers during his/her assigned tour of duty, provided the reserve officer qualifies or falls within the provisions of Penal Code § 832.6.

Culver City Police Department

Culver City PD Policy Manual

Reserve Officers

327.6.1 CARRYING WEAPON ON DUTY

Penal Code § 830.6(a)(1) permits qualified Level I, Level II and Level III reserve officers to carry a loaded firearm while on-duty. It is the policy of this department to allow qualified Level I, Level II and Level III reserves to carry firearms only while on-duty or to and from duty.

327.6.2 CONCEALED FIREARMS PROHIBITED

No reserve officer will be permitted to carry a concealed firearm while in an off-duty capacity, other than to and from work, except those reserve officers who possess a valid CCW permit or CCW endorsement on their department identification card. An instance may arise where a Level I or Level II reserve officer is assigned to a plainclothes detail for his/her assigned tour of duty. Under these circumstances, the reserve officer may be permitted to carry a weapon more suited to the assignment with the knowledge and approval of the supervisor in charge of the detail.

Any reserve officer who is permitted to carry a firearm other than the assigned duty weapon may do so only after verifying that the weapon conforms to departmental standards. The weapon must be registered in his/her name with the California Department of Justice. The firearm must be inspected by the department Rangemaster or his designee. The reserve officer must successfully qualify with the firearm during the department bi-annual qualifications and possess written authorization by the Chief of Police or their designee, prior to carrying the firearm on duty.

When a Level I or Level II reserve officer has satisfactorily completed all three phases of training (as outlined in the Field Training section), he/she may be issued a permit to carry a concealed weapon. The decision to authorize the reserve officer a concealed weapon permit will be made by the Chief of Police with input from the Reserve Program Coordinator and administrative staff. In issuing a concealed weapon permit a reserve officer's qualification will be individually judged. A reserve officer's dedication to the program and demonstrated maturity, among other factors, will be considered before a concealed weapon permit will be issued. Once issued, the concealed weapon permit will be valid only for as long as the reserve officer successfully qualifies during bi-annual qualifications and remains in good standing as a Reserve Officer with the Culver City Police Department.

327.6.3 RESERVE OFFICER FIREARM TRAINING

All reserve officers are required to maintain proficiency with firearms used in the course of their assignments. Reserve officers shall comply with all areas of the firearms training section of the Policy Manual, with the following exceptions:

- (a) Should a reserve officer fail to qualify by the second remediation attempt, that reserve officer will not be allowed to carry a firearm until he/she has reestablished his/her proficiency with the department Rangemaster or their designee.

327.7 EMERGENCY CALL-OUT FOR RESERVE PERSONNEL

The Reserve Coordinator shall develop a plan outlining an emergency call-out procedure for reserve personnel.

Culver City Police Department

Culver City PD Policy Manual

Reserve Officers

327.7.1 PLANNED EVENTS

Where the Department has prior knowledge of planned events such as parades, demonstrations and the like, plans will be finalized prior to the event. Use of the Police Reserve Section at the scene of such events shall be indicated in the Department plan and all Reserve Officers shall have prior knowledge of their respective assignments and responsibilities.

327.8 RESERVE OFFICER BASIC DUTIES

All Reserve Officers shall perform their duties as assigned in the same manner as Regular Officers, except as limited by the following:

- (a) Level III reserve officers may be deployed and are authorized only to carry out limited support duties not requiring general law enforcement powers in their routine performance. Those limited duties shall include traffic control, security at parades and sporting events, report taking, evidence transportation, parking enforcement and other duties that are not likely to result in physical arrests. Level III reserve officers, while assigned these duties, shall be supervised in the accessible vicinity by a Level I Reserve Officer or a full-time, regular peace officer. They shall not be assigned to work active patrol or detective assignments.
- (b) Level III reserve officers who successfully completed the Department physical agility test and were sworn in prior to January 01, 2017 may carry a firearm while on and off-duty. While performing the duties of a level III Reserve Officer, the Officer may wear the Department wool uniform or any other Department authorized uniform.
- (c) Level II Reserve Officers may be assigned the same or similar duties as a Regular Officer. Unless authorized by the Community Services Bureau Commander, Level II Reserve Officers shall not be assigned to any active enforcement duty without being accompanied by or directly supervised by a Regular Officer.
- (d) Level II reserve officers may be assigned without immediate supervision, to those limited duties that are authorized for Level III reserve officers. Level II reserve officers shall satisfy the continuing professional training requirement prescribed by P.O.S.T.
- (e) Level I Reserve Officers may be assigned to the same duties as a Regular Officer.
- (f) Such duties of any Reserve Officer as outlined above may be restricted by the policy or order of the Chief of Police, Bureau Commander, or Bureau Lieutenant.

327.9 LEAVE OF ABSENCE

The following procedures apply to those officers desiring to request a leave of absence from "Active" status within the Reserve Section:

- (a) Submit a written request to the Reserve Officer in Charge stating the reasons for desiring the leave.
- (b) The Reserve Section Officer in Charge shall review and forward the request to the Bureau Lieutenant for his review and submission to the Bureau Commander for his review and concurrence with the request. The Bureau Commander shall note the approval and cause it to be placed in the concerned officer's file. He shall then cause the officer to be notified of the result.

Culver City Police Department

Culver City PD Policy Manual

Reserve Officers

- (c) An official leave of absence shall not affect the "Active" status of the concerned officer, unless it extends beyond six months, at which time the officer shall be placed in an "Inactive" status.

327.10 RANK STRUCTURE

Reserve officer program rank structure will be determined by the Administration Bureau Commander based on the recommendations of the Reserve Coordinator and the Community/Media Relations Lieutenant.

327.11 RESERVE OFFICER CREDENTIALLED RETIREMENT

After twenty years of honorable service with the Department, Reserve Officer retirees may be issued an appropriate "retired" badge and identification card.

Outside Agency Assistance

328.1 PURPOSE AND SCOPE

The purpose of this policy is to provide guidance to members when requesting or responding to a request for mutual aid or when assisting another law enforcement agency.

328.2 POLICY

It is the policy of the Culver City Police Department to promptly respond to requests for assistance by other law enforcement agencies, subject to available resources and consistent with the applicable laws and policies of this department.

328.3 ASSISTING OUTSIDE AGENCIES

Generally, requests for any type of assistance from another agency should be routed to the Watch Commander's office for approval. In some instances, a memorandum of understanding or other established protocol may exist that eliminates the need for approval of individual requests.

When another law enforcement agency requests assistance from this department, the Watch Commander may authorize, if available, an appropriate number of personnel to assist. Members are reminded that their actions when rendering assistance must conform with applicable laws and be consistent with the policies of this department.

Officers may respond to a request for emergency assistance, however, they shall notify a supervisor of their activity as soon as practicable.

Arrestees may be temporarily detained by this department until arrangements for transportation are made by the outside agency. Probation violators who are temporarily detained by this department will not ordinarily be booked at this department. Only in exceptional circumstances, and subject to supervisor approval, will this department provide transportation of arrestees to other facilities on behalf of another agency.

When transportation assistance is rendered, a report shall be prepared and submitted by the handling member unless otherwise directed by a supervisor.

328.3.1 INITIATED ACTIVITY

Any on-duty officer who engages in law enforcement activities of any type that are not part of a mutual aid request and take place outside the jurisdiction of the Culver City Police Department shall notify his/her supervisor or the Watch Commander and Southbay RCC as soon as practicable. This requirement does not apply to special enforcement details or multi-agency units that regularly work in multiple jurisdictions.

328.4 REQUESTING OUTSIDE ASSISTANCE

If assistance is needed from another agency, the member requesting assistance should, if practicable, first notify a supervisor. The handling member or supervisor should direct assisting personnel to where they are needed and to whom they should report when they arrive.

Culver City Police Department

Culver City PD Policy Manual

Outside Agency Assistance

The requesting member should arrange for appropriate radio communication capabilities, if necessary and available, so that communication can be coordinated between assisting personnel.

328.5 REPORTING REQUIREMENTS

Incidents of outside assistance or law enforcement activities that are not documented in a crime report shall be documented in a Incident Report, Supervisor's Log or as directed by the Watch Commander.

Registered Offender Information

329.1 PURPOSE AND SCOPE

This policy establishes guidelines by which the Culver City Police Department will address issues associated with certain offenders who are residing in the jurisdiction and how the Department will disseminate information and respond to public inquiries for information about registered sex, arson and drug offenders.

329.2 POLICY

It is the policy of the Culver City Police Department to identify and monitor registered offenders living within this jurisdiction and to take reasonable steps to address the risks those persons may pose.

329.3 REGISTRATION

The Detective Bureau supervisor shall establish a process to reasonably accommodate registration of certain offenders. The process should rebut any allegation on the part of the offender that the registration process was too confusing, burdensome, or difficult for compliance. If it is reasonable to do so, an investigator assigned to related investigations should conduct the registration in order to best evaluate any threat the person may pose to the community. Those assigned to register offenders should receive appropriate training regarding the registration process.

Upon conclusion of the registration process, the investigator shall ensure that the registration information is provided to the California Department of Justice (DOJ) in accordance with applicable law (Penal Code § 457.1; Penal Code § 290 et seq.).

The refusal of a registrant to provide any of the required information or complete the process should initiate a criminal investigation for failure to register.

329.3.1 CONTENTS OF REGISTRATION

The information collected from the registering offenders shall include a signed statement as required by the California DOJ, fingerprints and a photograph, and any other information required by applicable law (Penal Code § 457.1; Penal Code § 290 et seq.).

329.4 MONITORING OF REGISTERED OFFENDERS

The Special Victim's Unit supervisor should establish a system to periodically, and at least once annually, verify that a registrant remains in compliance with his/her registration requirements after the initial registration. This verification should include:

- (a) Efforts to confirm residence using an unobtrusive method, such as an Internet search or drive-by of the declared residence.
- (b) Review of information on the California DOJ website for sex offenders.
- (c) Contact with a registrant's parole or probation officer.

Culver City Police Department

Culver City PD Policy Manual

Registered Offender Information

Any discrepancies should be reported to the California DOJ.

The Special Victim's Unit supervisor should also establish a procedure to routinely disseminate information regarding registered offenders to Culver City Police Department personnel, including timely updates regarding new or relocated registrants.

329.5 DISSEMINATION OF PUBLIC INFORMATION

Members will not unilaterally make a public notification advising the community of a particular registrant's presence in the community. Members who identify a significant risk or other public safety issue associated with a registrant should promptly advise their supervisor. The supervisor should evaluate the request and forward the information to the Chief of Police if warranted. A determination will be made by the Chief of Police, with the assistance of legal counsel as necessary, whether such a public alert should be made.

Members of the public requesting information on sex registrants should be provided the Megan's Law website or the Culver City Police Department's website. Information on sex registrants placed on the Culver City Police Department's website shall comply with the requirements of Penal Code § 290.46.

The Records Supervisor may release local registered offender information to residents only in accordance with applicable law and in compliance with a California Public Records Act request (Government Code § 7920.000 et seq.; Penal Code § 290.45; Penal Code § 290.46; Penal Code § 457.1).

329.5.1 LIMITED RELEASE WITHIN COLLEGE CAMPUS COMMUNITY

California law allows the following additional information regarding a registered sex offender on campus, whose information is not available to the public via the internet website, to be released to a campus community (Penal Code § 290.01(d)):

- (a) The offender's full name
- (b) The offender's known aliases
- (c) The offender's sex
- (d) The offender's race
- (e) The offender's physical description
- (f) The offender's photograph
- (g) The offender's date of birth
- (h) Crimes resulting in the registration of the offender under Penal Code § 290
- (i) The date of last registration

For purposes of this section, campus community shall be defined as those persons present at or regularly frequenting any place constituting campus property, satellite facilities, laboratories, public areas contiguous to the campus and other areas set forth in Penal Code § 290.01(d).

Culver City Police Department

Culver City PD Policy Manual

Registered Offender Information

329.5.2 RELEASE NOTIFICATIONS

Registrant information that is released should include notification that:

- (a) The offender registry includes only those persons who have been required by law to register and who are in compliance with the offender registration laws.
- (b) The information is provided as a public service and may not be current or accurate.
- (c) Persons should not rely solely on the offender registry as a safeguard against offenses in their communities.
- (d) The crime for which a person is convicted may not accurately reflect the level of risk.
- (e) Anyone who uses information contained in the registry to harass registrants or commit any crime may be subject to criminal prosecution.
- (f) The purpose of the release of information is to allow members of the public to protect themselves and their children from sex offenders (Penal Code 290.45).

Major Incident Notification

330.1 PURPOSE AND SCOPE

The purpose of this policy is to provide guidance to members of this department in determining when, how and to whom notification of major incidents should be made.

330.2 POLICY

The Culver City Police Department recognizes that certain incidents should be brought to the attention of supervisors or other specified personnel of this department to facilitate the coordination of activities and ensure that inquiries from the media and the public may be properly addressed.

330.3 MINIMUM CRITERIA FOR NOTIFICATION

Most situations where the media show a strong interest are also of interest to the Chief of Police and the affected Bureau Commander. The following list of incident types is provided as a guide for notification and is not intended to be all inclusive:

- Homicides
- Traffic accidents with fatalities
- Officer-involved shooting - on or off duty (see Officer-Involved Shootings and Deaths Policy for special notifications)
- Significant injury or death to employee - on or off duty
- Death of a prominent Culver City official
- Arrest of a department employee or prominent Culver City official
- Aircraft crash with major damage and/or injury or death
- In-custody deaths

330.4 WATCH COMMANDER RESPONSIBILITY

The Watch Commander is responsible for making the appropriate notifications. The Watch Commander shall make reasonable attempts to obtain as much information on the incident as possible before notification. The Watch Commander shall attempt to make the notifications as soon as practicable. Notification should be made by calling the cellular telephone number first and then by any other available contact numbers.

330.4.1 STAFF NOTIFICATION

In the event an incident occurs described in the Major Incident Notification Policy, the Chief of Police shall be notified along with the affected Bureau Commander and the Detective Lieutenant if that bureau is affected.

330.4.2 DETECTIVE NOTIFICATION

If the incident requires that a detective respond from home, the immediate supervisor of the appropriate detail shall be contacted who will then contact the appropriate detective. If the

Culver City Police Department

Culver City PD Policy Manual

Major Incident Notification

immediate supervisor of the appropriate detail can not be reached, the on-duty Watch Commander may make the notification the appropriate detective directly.

330.4.3 OPERATIONS BUREAU NOTIFICATION

In the event of a traffic fatality or major injury, the Traffic Sergeant shall be notified who will then contact the appropriate accident investigator. The Traffic Sergeant will notify the Traffic Lieutenant.

330.4.4 PUBLIC INFORMATION OFFICER (PIO)

The Public Information Officer shall be called after members of staff have been notified if it appears the media may have a significant interest in the incident.

Death Investigation

331.1 PURPOSE AND SCOPE

The purpose of this policy is to provide guidelines for situations where officers initially respond to and investigate the circumstances of a deceased person.

Some causes of death may not be readily apparent, and some cases differ substantially from what they appeared to be initially. The thoroughness of death investigations and use of appropriate resources and evidence gathering techniques is critical.

331.2 INVESTIGATION CONSIDERATIONS

Emergency medical services shall be called in all suspected death cases unless the death is obvious (e.g., decapitated, decomposed).

A supervisor shall be notified as soon as possible to assist and provide appropriate personnel and resources. The on-scene supervisor should determine whether follow-up investigation is required and notify the Investigations Bureau Bureau Commander as necessary. The Watch Commander will make notification to command staff in accordance with the Major Incident Notification Policy.

331.2.1 CORONER REQUEST

Government Code § 27491 and Health and Safety Code § 102850 direct the Coroner to inquire into and determine the circumstances, manner, and cause of certain deaths. The Coroner shall be called in any of the following cases:

- (a) Unattended deaths (No physician in attendance or during the continued absence of the attending physician. This also includes all deaths outside hospitals and nursing care facilities.)
- (b) Deaths where the deceased has not been attended by either a physician or a registered nurse who is a member of a hospice care interdisciplinary team, as defined by Health and Safety Code § 1746, in the 20 days prior to death
- (c) Deaths where the physician is unable to state the cause of death. Unwillingness does not apply. This includes all sudden, unexpected, and unusual deaths, and fetal deaths when the underlying cause is unknown.
- (d) Known or suspected homicide
- (e) Known or suspected suicide (including suicide where the deceased has a history of being victimized by domestic violence)
- (f) Deaths involving any criminal action or suspicion of a criminal act. This includes child and dependent adult negligence and abuse.
- (g) Deaths related to or following known or suspected self-induced or criminal abortion
- (h) Deaths associated with a known or alleged rape or crime against nature
- (i) Deaths following an accident or injury (primary or contributory). This includes deaths known or suspected as resulting (in whole or in part) from or related to accident or injury, either old or recent.

Culver City Police Department

Culver City PD Policy Manual

Death Investigation

- (j) Deaths from drowning, fire, hanging, gunshot, stabbing, cutting, starvation, exposure, alcoholism, drug addiction, strangulation, or aspiration
- (k) Deaths from accidental poisoning (e.g., food, chemical, drug, therapeutic agents)
- (l) Deaths from occupational diseases or occupational hazards
- (m) Deaths from known or suspected contagious disease and constituting a public hazard
- (n) All deaths in operating rooms and all deaths where a patient has not fully recovered from an anesthetic, whether in surgery, recovery room, or elsewhere
- (o) Deaths that occur in prison or while under sentence. This includes all in-custody and police-involved deaths.
- (p) All deaths of unidentified persons
- (q) All deaths of state hospital patients
- (r) Suspected Sudden Infant Death Syndrome (SIDS) deaths
- (s) All deaths where the patient is comatose throughout the period of the physician's attendance. This includes patients that are admitted to hospitals unresponsive and expire without regaining consciousness.

The body shall not be disturbed or moved from the position or place of death without permission of the Coroner.

331.2.2 SEARCHING DEAD BODIES

- (a) The Coroner or a designee is generally the only person permitted to search a body known to be dead from any of the circumstances set forth in Government Code § 27491. The only exception is that an officer is permitted to search the body of a person killed in a traffic collision for the limited purpose of locating an anatomical donor card. If such a donor card is located, the Coroner or a designee shall be promptly notified (Government Code § 27491.3).
- (b) The Coroner, with the permission of the Department, may take property, objects, or articles found on the deceased or in the immediate vicinity of the deceased that may be necessary for conducting an investigation to determine the identity of the deceased or the cause or manner of death (Government Code § 27491.3).
- (c) Should exigent circumstances indicate to an officer that any other search of a known dead body is warranted prior to the arrival of the Coroner or a designee, the investigating officer should first obtain verbal consent from the Coroner or a designee (Government Code § 27491.2).
- (d) Whenever reasonably possible, a witness, preferably a relative to the deceased or a member of the household, should be requested to remain nearby the scene and available to the officer pending the arrival of the Coroner or a designee. The name and address of this person shall be included in the narrative of the death report.
- (e) Whenever personal effects are removed from the body of the deceased by the Coroner or a designee, a receipt shall be obtained. This receipt shall be attached to the death report.

Culver City Police Department

Culver City PD Policy Manual

Death Investigation

331.2.3 DEATH NOTIFICATION

When practical, and if not handled by the Coroner's Office, notification to the next-of-kin of the deceased person shall be made, in person, by the officer assigned to the incident. If the next-of-kin lives in another jurisdiction, a law enforcement official from that jurisdiction shall be requested to make the personal notification. If the relatives live outside this county, the Coroner may be requested to make the notification. The Coroner needs to know if notification has been made. Assigned detectives may need to talk to the next-of-kin.

331.2.4 REPORTING

All incidents involving a death shall be documented on the appropriate form.

331.2.5 SUSPECTED HOMICIDE

If the initially assigned officer suspects that the death involves a homicide or other suspicious circumstances, the officer shall take steps to protect the scene. The Detective Bureau shall be notified to determine the possible need for an investigator to respond to the scene.

If the on-scene supervisor, through consultation with the Watch Commander or Detective Bureau supervisor, is unable to determine the manner of death, the investigation shall proceed as though it is a homicide.

The investigator assigned to investigate a homicide or death that occurred under suspicious circumstances may, with the approval of their supervisor, request the Coroner to conduct physical examinations and tests, and to provide a report.

331.2.6 EMPLOYMENT-RELATED DEATHS OR INJURIES

Any member of this agency who responds to a death, serious illness, or serious injury and determines that it has occurred as a result of an accident at or in connection with the victim's employment shall ensure that the nearest office of Cal-OSHA is notified by telephone immediately or as soon as practicable with all pertinent information (8 CCR 342(b)).

331.2.7 DEATHS OF VICTIMS WITH AN IDENTIFIABLE HISTORY OF VICTIMIZED DOMESTIC VIOLENCE

Prior to making any findings as to the manner and cause of death of a deceased individual with an identifiable history of being victimized by domestic violence, investigating officers should consider factors identified in Penal Code § 679.07 (e.g., premature or untimely death, partner wanting to end relationship, scene gives appearance of death due to suicide or accident) and proceed with the investigation according to the code's requirements.

331.3 POLICY

It is the policy of the Culver City Police Department to respond to, document, and investigate incidents where a person is deceased. Investigations involving the death of a person, including deaths from natural causes, accidents, workplace incidents, suicide, and homicide, shall be initiated, conducted, and properly documented.

Culver City Police Department

Culver City PD Policy Manual

Death Investigation

331.4 UNIDENTIFIED DEAD BODY

If the identity of a dead body cannot be established, the handling officer will request from the Coroner a unique identifying number for the body. The number shall be included in any report.

Occupational Injury or Death Response

332.1 PURPOSE AND SCOPE

California's Occupational Safety and Health Administration (O.S.H.A.) is responsible for issuing rules designed to ensure a safe and healthy work environment for workers throughout the state. A violation of those rules may result not only in administrative fines and penalties, but also potential criminal liability. Per Penal Code Section 387 and Labor Code Section 6425, employers and/or employees may be guilty of a felony if they are found to be willfully in violation of safety rules that cause death or serious injury to any worker. As a result, any employee or employer with control over a workplace may be guilty of a homicide in the event of a workplace death.

The Los Angeles County District Attorney's Office has been instructed to become involved at the earliest possible moment during the investigation of occupational deaths and life-threatening injuries at a workplace. This also includes significant violations of environmental laws that pose substantial and serious threats to public safety and/or the environment. The Los Angeles County District Attorney's Office, in appropriate cases, intends to "roll out" to the scene of such incidents and assist in the investigations. The responding team will consist of one or more District Attorney Investigators and, if appropriate, a Deputy District Attorney. The Culver City Police Department has entered into an operational agreement with the Los Angeles County District Attorney's Office regarding a notification process when such circumstances arise.

332.2 REPORTING

When an occupational death or serious injury in the workplace occurs, or a significant violation of environmental law that poses a serious threat to public safety and/or the environment occurs, the Los Angeles County District Attorney's Command Center shall be notified immediately at (213) 974-3607. The Culver City Police Department shall provide the following to the Command Center:

- (a) Department call back number and a brief description of the incident.
- (b) The name and location of the employer and/or the potential responsible party.
- (c) The name and age of the deceased or injured person(s), severity of injuries, the manner in which the injury was sustained and the contact information for the employer's safety manager.

Upon arrival of the District Attorney roll out team, the Culver City Police Department shall maintain the primary responsibility to investigate the incident. The responsibility of the District Attorney roll out team will consist of assisting and advising the lead investigator on applicable criminal law issues, participate in the investigation when appropriate, and observe the overall investigation. As soon as practical, the Culver City Police Department will provide the following to the on-scene District Attorney roll out team:

- (a) An initial briefing of the incident.
- (b) The names and present whereabouts of the first responding officers and lead investigator.

Culver City Police Department

Culver City PD Policy Manual

Occupational Injury or Death Response

- (c) The names, contact information and present whereabouts of all civilian witnesses including copies of all F.I. cards.
- (d) Any recorded or annotated statements from first responders, investigators, and civilian witnesses.
- (e) Any physical evidence discovered.(All physical evidence shall remain in the custody of the Culver City Police Department or the Los Angeles County Coroner's Office respectively).
- (f) A walkthrough of the scene.
- (g) The medical condition of any and all injured persons.

Identity Theft

333.1 PURPOSE AND SCOPE

Identity theft is a growing trend that frequently involves related crimes in multiple jurisdictions. This policy is intended to provide guidelines for the reporting and investigation of such crimes.

333.2 REPORTING

- (a) In an effort to maintain uniformity in reporting, officers presented with the crime of identity theft (Penal Code § 530.6) shall initiate a report for victims residing within the jurisdiction of this department. For incidents of identity theft occurring outside this jurisdiction, officers should observe the following:
 1. For any victim not residing within this jurisdiction, the officer may either take a courtesy report to be forwarded to the victim's residence agency or the victim should be encouraged to promptly report the identity theft to the law enforcement agency where he or she resides.
- (b) While the crime of identity theft should be reported to the law enforcement agency where the victim resides, officers of this department should investigate and report crimes occurring within this jurisdiction which have resulted from the original identity theft (e.g., the identity theft occurred elsewhere, but the credit card fraud occurred and is reported in this jurisdiction).
- (c) Officers should include all known incidents of fraudulent activity (e.g., credit card number applied for in victim's name when the victim has never made such an application).
- (d) Officers should also cross-reference all known reports made by the victim (e.g., U.S. Secret Service, credit reporting bureaus, U.S. Postal Service and DMV) with all known report numbers.
- (e) The reporting officer should inform victims of identity theft that the California Identity Theft Registry ([HTTP://ag.ca.gov/idtheft/general.htm](http://ag.ca.gov/idtheft/general.htm)) is available to help those who are wrongly linked to crimes. The registry can be checked by law enforcement and other authorized persons to investigate whether a criminal history or want was created in the victim's name (Penal Code § 530.7). Information regarding the California Identity Theft Registry can be obtained by calling toll free (888) 880-0240.
- (f) Following supervisory review and departmental processing, the initial report should be forwarded to the appropriate detective for follow up investigation, coordination with other agencies and prosecution as circumstances dictate.

Private Persons Arrests

334.1 PURPOSE AND SCOPE

The purpose of this policy is to provide guidance for the handling of private person's arrests made pursuant to Penal Code § 837.

334.2 ADVISING PRIVATE PERSONS OF THE ARREST PROCESS

Penal Code § 836(b) expressly mandates that all officers shall advise victims of domestic violence of the right to make a private person's arrest, including advice on how to safely execute such an arrest. In all other situations, officers should use sound discretion in determining whether or not to advise an individual of the arrest process.

- (a) When advising any individual regarding the right to make a private person's arrest, officers should refrain from encouraging or dissuading any individual from making such an arrest and should instead limit advice to the legal requirements for such an arrest as listed below.
- (b) Private individuals should be discouraged from using force to effect a private person's arrest, and absent immediate threat to their own safety or the safety of others, private individuals should be encouraged to refer matters to law enforcement officials for further investigation or arrest.

334.3 ARRESTS BY PRIVATE PERSONS

Penal Code § 837 provides that a private person may arrest another:

- (a) For a public offense committed or attempted in his or her presence;
- (b) When the person arrested has committed a felony, although not in his or her presence;
- (c) When a felony has been in fact committed, and he or she has reasonable cause for believing the person arrested has committed it.

Unlike peace officers, private persons may not make an arrest on suspicion that a felony has been committed - the felony must in fact have taken place.

334.4 OFFICER RESPONSIBILITIES

Any officer presented with a private person wishing to make an arrest must determine whether or not there is reasonable cause to believe that such an arrest would be lawful (Penal Code § 847).

- (a) Should any officer determine that there is no reasonable cause to believe that a private person's arrest is lawful, the officer should take no action to further detain or restrain the individual beyond that which reasonably appears necessary to investigate the matter, determine the lawfulness of the arrest and protect the public safety.
 1. Any officer who determines that a private person's arrest appears to be unlawful should promptly release the arrested individual pursuant to Penal Code § 849(b)(1). The officer must include the basis of such a determination in a related report.

Culver City Police Department

Culver City PD Policy Manual

Private Persons Arrests

2. Absent reasonable cause to support a private person's arrest or other lawful grounds to support an independent arrest by the officer, the officer should advise the parties that no arrest will be made and that the circumstances will be documented in a related report.
- (b) Whenever an officer determines that there is reasonable cause to believe that a private person's arrest is lawful, the officer may exercise any of the following options:
1. Take the individual into physical custody for booking
 2. Release the individual pursuant to a Notice to Appear
 3. Release the individual pursuant to Penal Code § 849

334.5 REPORTING REQUIREMENTS

In all circumstances in which a private person is claiming to have made an arrest, the individual must complete and sign a department Private Person's Arrest form under penalty of perjury.

In addition to the Private Person's Arrest Form (and any other related documents such as citations, booking forms, etc.), officers shall complete a narrative report regarding the circumstances and disposition of the incident.

Limited English Proficiency Services

336.1 PURPOSE AND SCOPE

This policy provides guidance to members when communicating with individuals with limited English proficiency (LEP) (42 USC § 2000d).

336.1.1 DEFINITIONS

Definitions related to this policy include:

Authorized interpreter - A person who has been screened and authorized by the Department to act as an interpreter and/or translator for others.

Interpret or interpretation - The act of listening to a communication in one language (source language) and orally converting it to another language (target language), while retaining the same meaning.

Limited English proficient (LEP) - Any individual whose primary language is not English and who has a limited ability to read, write, speak or understand English. These individuals may be competent in certain types of communication (e.g., speaking or understanding) but still be LEP for other purposes (e.g., reading or writing). Similarly, LEP designations are context-specific; an individual may possess sufficient English language skills to function in one setting but these skills may be insufficient in other situations.

Qualified bilingual member - A member of the Culver City Police Department, designated by the Department, who has the ability to communicate fluently, directly and accurately in both English and another language. Bilingual members may be fluent enough to communicate in a non-English language but may not be sufficiently fluent to interpret or translate from one language into another.

Translate or translation - The replacement of written text from one language (source language) into an equivalent written text (target language).

336.2 POLICY

It is the policy of the Culver City Police Department to reasonably ensure that LEP individuals have meaningful access to law enforcement services, programs and activities, while not imposing undue burdens on its members.

The Department will not discriminate against or deny any individual access to services, rights or programs based upon national origin or any other protected interest or right.

336.3 FOUR-FACTOR ANALYSIS

Since there are many different languages that members could encounter, the Department will utilize the four-factor analysis outlined in the U.S. Department of Justice (DOJ) Guidance to Federal Financial Assistance Recipients, available at the DOJ website, to determine which measures will provide meaningful access to its services and programs. It is recognized that law enforcement contacts and circumstances will vary considerably. This analysis, therefore, must remain flexible and will require an ongoing balance of four factors, which are:

Culver City Police Department

Culver City PD Policy Manual

Limited English Proficiency Services

- (a) The number or proportion of LEP individuals eligible to be served or likely to be encountered by department members, or who may benefit from programs or services within the jurisdiction of the Department or a particular geographic area.
- (b) The frequency with which LEP individuals are likely to come in contact with department members, programs or services.
- (c) The nature and importance of the contact, program, information or service provided.
- (d) The cost of providing LEP assistance and the resources available.

336.4 TYPES OF LEP ASSISTANCE AVAILABLE

Culver City Police Department members should never refuse service to an LEP individual who is requesting assistance, nor should they require an LEP individual to furnish an interpreter as a condition for receiving assistance. The Department will make every reasonable effort to provide meaningful and timely assistance to LEP individuals through a variety of services.

The Department will utilize all reasonably available tools, such as language identification cards, when attempting to determine an LEP individual's primary language.

LEP individuals may choose to accept department-provided LEP services at no cost or they may choose to provide their own.

Department-provided LEP services may include, but are not limited to, the assistance methods described in this policy.

336.5 WRITTEN FORMS AND GUIDELINES

Vital documents or those that are frequently used should be translated into languages most likely to be encountered. The LEP Coordinator will arrange to make these translated documents available to members and other appropriate individuals, as necessary.

336.6 AUDIO RECORDINGS

The Department may develop audio recordings of important or frequently requested information in a language most likely to be understood by those LEP individuals who are representative of the community being served.

336.7 QUALIFIED BILINGUAL MEMBERS

Bilingual members may be qualified to provide LEP services when they have demonstrated through established department procedures a sufficient level of skill and competence to fluently communicate in both English and a non-English language. Members utilized for LEP services must demonstrate knowledge of the functions of an interpreter/translator and the ethical issues involved when acting as a language conduit. Additionally, bilingual members must be able to communicate technical and law enforcement terminology, and be sufficiently proficient in the non-English language to perform complicated tasks, such as conducting interrogations, taking statements, collecting evidence or conveying rights or responsibilities.

Culver City Police Department

Culver City PD Policy Manual

Limited English Proficiency Services

When a qualified bilingual member from this department is not available, personnel from other City departments, who have been identified by the Department as having the requisite skills and competence, may be requested.

336.8 AUTHORIZED INTERPRETERS

Any person designated by the Department to act as an authorized interpreter and/or translator must have demonstrated competence in both English and the involved non-English language, must have an understanding of the functions of an interpreter that allows for correct and effective translation, and should not be a person with an interest in the department case or investigation involving the LEP individual. A person providing interpretation or translation services may be required to establish the accuracy and trustworthiness of the interpretation or translation in a court proceeding.

Authorized interpreters must pass a screening process established by Human Resources which demonstrates that their skills and abilities include:

- (a) The competence and ability to communicate information accurately in both English and in the target language.
- (b) Knowledge, in both languages, of any specialized terms or concepts peculiar to this department and of any particularized vocabulary or phraseology used by the LEP individual.
- (c) The ability to understand and adhere to the interpreter role without deviating into other roles, such as counselor or legal adviser.
- (d) Knowledge of the ethical issues involved when acting as a language conduit.

336.8.1 SOURCES OF AUTHORIZED INTERPRETERS

The Department may contract with authorized interpreters who are available over the telephone. Members may use these services with the approval of a supervisor and in compliance with established procedures.

Other sources may include:

- Qualified bilingual members of this department or personnel from other City departments.
- Individuals employed exclusively to perform interpretation services.
- Contracted in-person interpreters, such as state or federal court interpreters, among others.
- Interpreters from other agencies who have been qualified as interpreters by this department, and with whom the Department has a resource-sharing or other arrangement that they will interpret according to department guidelines.

Culver City Police Department

Culver City PD Policy Manual

Limited English Proficiency Services

336.8.2 COMMUNITY VOLUNTEERS AND OTHER SOURCES OF LANGUAGE ASSISTANCE

Language assistance may be available from community volunteers who have demonstrated competence in either monolingual (direct) communication and/or in interpretation or translation (as noted in above), and have been approved by the Department to communicate with LEP individuals.

Where qualified bilingual members or other authorized interpreters are unavailable to assist, approved community volunteers who have demonstrated competence may be called upon when appropriate. However, department members must carefully consider the nature of the contact and the relationship between the LEP individual and the volunteer to ensure that the volunteer can provide neutral and unbiased assistance.

While family or friends of an LEP individual may offer to assist with communication or interpretation, members should carefully consider the circumstances before relying on such individuals. For example, children should not be relied upon except in exigent or very informal and non-confrontational situations.

336.9 CONTACT AND REPORTING

While all law enforcement contacts, services and individual rights are important, this department will utilize the four-factor analysis to prioritize service to LEP individuals so that such services may be targeted where they are most needed, according to the nature and importance of the particular law enforcement activity involved.

Whenever any member of this department is required to complete a report or other documentation, and interpretation services are provided to any involved LEP individual, such services should be noted in the related report. Members should document the type of interpretation services utilized and whether the individual elected to use services provided by the Department or some other identified source.

336.10 RECEIVING AND RESPONDING TO REQUESTS FOR ASSISTANCE

The Culver City Police Department will take reasonable steps and will work with Human Resources to develop in-house language capacity by hiring or appointing qualified members proficient in languages representative of the community being served.

336.10.1 EMERGENCY CALLS TO 9-1-1

Department members will make every reasonable effort to promptly accommodate LEP individuals utilizing 9-1-1 lines. When a 9-1-1 call-taker receives a call and determines that the caller is an LEP individual, the call-taker shall quickly determine whether sufficient information can be obtained to initiate an appropriate emergency response. If language assistance is still needed, the language is known and a qualified bilingual member is available in Southbay RCC, the call shall immediately be handled by the qualified bilingual member.

If a qualified bilingual member is not available or the call-taker is unable to identify the caller's language, the call-taker will contact the contracted telephone interpretation service and establish a three-way call between the call-taker, the LEP individual and the interpreter.

Culver City Police Department

Culver City PD Policy Manual

Limited English Proficiency Services

Dispatchers will make every reasonable effort to dispatch a qualified bilingual member to the assignment, if available and appropriate.

While 9-1-1 calls shall receive top priority, reasonable efforts should also be made to accommodate LEP individuals seeking routine access to services and information by utilizing the resources listed in this policy.

336.11 FIELD ENFORCEMENT

Field enforcement will generally include such contacts as traffic stops, pedestrian stops, serving warrants and restraining orders, crowd/traffic control and other routine field contacts that may involve LEP individuals. The scope and nature of these activities and contacts will inevitably vary. Members and/or supervisors must assess each situation to determine the need and availability of language assistance to all involved LEP individuals and utilize the methods outlined in this policy to provide such assistance.

Although not every situation can be addressed in this policy, it is important that members are able to effectively communicate the reason for a contact, the need for information and the meaning or consequences of any enforcement action. For example, it would be meaningless to request consent to search if the officer is unable to effectively communicate with an LEP individual.

If available, officers should obtain the assistance of a qualified bilingual member or an authorized interpreter before placing an LEP individual under arrest.

336.12 INVESTIGATIVE FIELD INTERVIEWS

In any situation where an interview may reveal information that could be used as the basis for arrest or prosecution of an LEP individual and a qualified bilingual member is unavailable or lacks the skills to directly communicate with the LEP individual, an authorized interpreter should be used. This includes interviews conducted during an investigation with victims, witnesses and suspects. In such situations, audio recordings of the interviews should be made when reasonably possible. Identification and contact information for the interpreter (e.g., name, address) should be documented so that the person can be subpoenaed for trial if necessary.

If an authorized interpreter is needed, officers should consider calling for an authorized interpreter in the following order:

- An authorized department member or allied agency interpreter
- An authorized telephone interpreter
- Any other authorized interpreter

Any *Miranda* warnings shall be provided to suspects in their primary language by an authorized interpreter or, if the suspect is literate, by providing a translated *Miranda* warning card.

The use of an LEP individual's bilingual friends, family members, children, neighbors or bystanders may be used only when a qualified bilingual member or authorized interpreter is unavailable and there is an immediate need to interview an LEP individual.

Culver City Police Department

Culver City PD Policy Manual

Limited English Proficiency Services

336.13 CUSTODIAL INTERROGATIONS

Miscommunication during custodial interrogations may have a substantial impact on the evidence presented in a criminal prosecution. Only qualified bilingual members or, if none is available or appropriate, authorized interpreters shall be used during custodial interrogations. *Miranda* warnings shall be provided to suspects in their primary language by the qualified bilingual member or an authorized interpreter.

In order to ensure that translations during custodial interrogations are accurately documented and are admissible as evidence, interrogations should be recorded whenever reasonably possible. See guidance on recording custodial interrogations in the Investigation and Prosecution Policy.

336.14 BOOKINGS

When gathering information during the booking process, members should remain alert to the impediments that language barriers can create. In the interest of the arrestee's health and welfare, the safety and security of the facility, and to protect individual rights, it is important that accurate medical screening and booking information be obtained. Members should seek the assistance of a qualified bilingual member whenever there is concern that accurate information cannot be obtained or that booking instructions may not be properly understood by an LEP individual.

336.15 COMPLAINTS

The Department shall ensure that LEP individuals who wish to file a complaint regarding members of this department are able to do so. The Department may provide an authorized interpreter or translated forms, as appropriate. Complaints will be referred to the LEP Coordinator.

Investigations into such complaints shall be handled in accordance with the Personnel Complaints Policy. Authorized interpreters used for any interview with an LEP individual during an investigation should not be members of this department.

Any notice required to be sent to an LEP individual as a complaining party pursuant to the Personnel Complaints Policy should be translated or otherwise communicated in a language-accessible manner.

336.16 TRAINING

To ensure that all members who may have contact with LEP individuals are properly trained, the Department will provide periodic training on this policy and related procedures, including how to access department-authorized telephonic and in-person interpreters and other available resources.

The Personnel and Training Section shall be responsible for ensuring new members receive LEP training. Those who may have contact with LEP individuals should receive refresher training at least once every two years thereafter. The Personnel and Training Section shall maintain records of LEP training provided, and will retain a copy in each member's training file in accordance with established records retention schedules.

Communications with Persons with Disabilities

337.1 PURPOSE AND SCOPE

This policy provides guidance to members when communicating with individuals with disabilities, including those who are deaf or hard of hearing, have impaired speech or vision, or are blind.

337.1.1 DEFINITIONS

Definitions related to this policy include:

Auxiliary aids - Tools used to communicate with people who have a disability or impairment. They include, but are not limited to, the use of gestures or visual aids to supplement oral communication; a notepad and pen or pencil to exchange written notes; a computer or typewriter; an assistive listening system or device to amplify sound; a teletypewriter (TTY) or videophones (video relay service or VRS); taped text; qualified readers; or a qualified interpreter.

Disability or impairment - A physical or mental impairment that substantially limits a major life activity, including hearing or seeing, regardless of whether the disabled person uses assistive or adaptive devices or auxiliary aids. Individuals who wear ordinary eyeglasses or contact lenses are not considered to have a disability (42 USC § 12102).

Qualified interpreter - A person who is able to interpret effectively, accurately and impartially, both receptively and expressively, using any necessary specialized vocabulary. Qualified interpreters include oral interpreters, translators, sign language interpreters and intermediary interpreters.

337.2 POLICY

It is the policy of the Culver City Police Department to reasonably ensure that people with disabilities, including victims, witnesses, suspects and arrestees have equal access to law enforcement services, programs and activities. Members must make efforts to communicate effectively with individuals with disabilities.

The Department will not discriminate against or deny any individual access to services, rights or programs based upon disabilities.

337.3 AMERICANS WITH DISABILITIES (ADA) COORDINATOR

All Americans with Disabilities (ADA) issues and complaints shall be directed to the Human Resources Department (28 CFR 35.107).

337.4 FACTORS TO CONSIDER

Because the nature of any law enforcement contact may vary substantially from one situation to the next, members of this department should consider all information reasonably available to them when determining how to communicate with an individual with a disability. Members should carefully balance all known factors in an effort to reasonably ensure people who are disabled have equal access to services, programs and activities. These factors may include, but are not limited to:

Culver City Police Department

Culver City PD Policy Manual

Communications with Persons with Disabilities

- (a) Members should not always assume that effective communication is being achieved. The fact that an individual appears to be nodding in agreement does not always mean he/she completely understands the message. When there is any doubt, members should ask the individual to communicate back or otherwise demonstrate their understanding.
- (b) The nature of the disability (e.g., deafness or blindness vs. hard of hearing or low vision).
- (c) The nature of the law enforcement contact (e.g., emergency vs. non-emergency, custodial vs. consensual contact).
- (d) The availability of auxiliary aids. The fact that a particular aid is not available does not eliminate the obligation to reasonably ensure access. However, in an emergency, availability may factor into the type of aid used.

337.5 INITIAL AND IMMEDIATE CONSIDERATIONS

Recognizing that various law enforcement encounters may be potentially volatile and/or emotionally charged, members should remain alert to the possibility of communication problems.

Members should exercise special care in the use of all gestures, and verbal and written communication to minimize initial confusion and misunderstanding when dealing with any individual with known or suspected disabilities.

In a non-emergency situation, when a member knows or suspects an individual requires assistance to effectively communicate, the member shall identify the individual's choice of auxiliary aid or service.

The individual's preferred communication method must be honored unless another effective method of communication exists under the circumstances (28 CFR 35.160).

Factors to consider when determining whether an alternative method is effective include:

- (a) The methods of communication usually used by the individual.
- (b) The nature, length and complexity of the communication involved.
- (c) The context of the communication.

In emergency situations involving an imminent threat to the safety or welfare of any person, members may use whatever auxiliary aids and services that reasonably appear effective under the circumstances. This may include, for example, exchanging written notes or using the services of a person who knows sign language but is not a qualified interpreter, even if the person who is deaf or hard of hearing would prefer a qualified sign language interpreter or another appropriate auxiliary aid or service. Once the emergency has ended, the continued method of communication should be reconsidered. The member should inquire as to the individual's preference and give primary consideration to that preference.

Culver City Police Department

Culver City PD Policy Manual

Communications with Persons with Disabilities

If an individual who is deaf, hard of hearing or has impaired speech must be handcuffed while in the custody of the Culver City Police Department, consideration should be given, safety permitting, to placing the handcuffs in the front of the body to facilitate communication using sign language or writing.

337.6 TYPES OF ASSISTANCE AVAILABLE

Culver City Police Department members shall never refuse to assist an individual with disabilities who is requesting assistance. The Department will not charge anyone to receive auxiliary aids, nor shall they require anyone to furnish their own auxiliary aid or service as a condition for receiving assistance. The Department will make every reasonable effort to provide equal access and timely assistance to individuals who are disabled through a variety of services.

A person who is disabled may choose to accept department-provided auxiliary aids or services or they may choose to provide their own.

Department-provided auxiliary aids or services may include, but are not limited to, the assistance methods described in this policy.

337.7 AUDIO RECORDINGS AND ENLARGED PRINT

The Department may develop audio recordings to assist people who are blind or have a visual impairment with accessing important information. If such a recording is not available, members may read aloud from the appropriate form, for example a personnel complaint form, or provide forms with enlarged print.

337.8 QUALIFIED INTERPRETERS

A qualified interpreter may be needed in lengthy or complex transactions (e.g., interviewing a victim, witness, suspect or arrestee), if the individual to be interviewed normally relies on sign language or speechreading (lip-reading) to understand what others are saying. The qualified interpreter should not be a person with an interest in the case or investigation involving the disabled individual. A person providing interpretation services may be required to establish the accuracy and trustworthiness of the interpretation in a court proceeding.

Qualified interpreters should be:

- (a) Available within a reasonable amount of time but in no event longer than one hour if requested.
- (b) Experienced in providing interpretation services related to law enforcement matters.
- (c) Familiar with the use of VRS and/or video remote interpreting services.
- (d) Certified in either American Sign Language (ASL) or Signed English (SE).
- (e) Able to understand and adhere to the interpreter role without deviating into other roles, such as counselor or legal adviser.
- (f) Knowledgeable of the ethical issues involved when providing interpreter services.

Culver City Police Department

Culver City PD Policy Manual

Communications with Persons with Disabilities

Members should use department-approved procedures to request a qualified interpreter at the earliest reasonable opportunity, and generally not more than 15 minutes after a request for an interpreter has been made or it is reasonably apparent that an interpreter is needed. No individual who is disabled shall be required to provide his/her own interpreter (28 CFR 35.160).

337.9 TTY AND RELAY SERVICES

In situations where an individual without a disability would have access to a telephone (e.g., booking or attorney contacts), members must also provide those who are deaf, hard of hearing or have impaired speech the opportunity to place calls using an available TTY (also known as a telecommunications device for deaf people, or TDD). Members shall provide additional time, as needed, for effective communication due to the slower nature of TTY and TDD communications.

The Department will accept all TTY or TDD calls placed by those who are deaf or hard of hearing and received via a telecommunications relay service (28 CFR 35.162).

Note that relay services translate verbatim, so the conversation must be conducted as if speaking directly to the caller.

337.10 COMMUNITY VOLUNTEERS

Interpreter services may be available from community volunteers who have demonstrated competence in communication services, such as ASL or SE, and have been approved by the Department to provide interpreter services.

Where qualified interpreters are unavailable to assist, approved community volunteers who have demonstrated competence may be called upon when appropriate. However, department members must carefully consider the nature of the contact and the relationship between the individual with the disability and the volunteer to ensure that the volunteer can provide neutral and unbiased assistance.

337.11 FAMILY AND FRIENDS

While family or friends may offer to assist with interpretation, members should carefully consider the circumstances before relying on such individuals. The nature of the contact and relationship between the individual with the disability and the person offering services must be carefully considered (e.g., victim/suspect).

Children shall not be relied upon except in emergency or critical situations when there is no qualified interpreter reasonably available.

Adults may be relied upon when (28 CFR 35.160):

- (a) There is an emergency or critical situation and there is no qualified interpreter reasonably available.
- (b) The person with the disability requests that the adult interpret or facilitate communication and the adult agrees to provide such assistance, and reliance on that adult for such assistance is reasonable under the circumstances.

Culver City Police Department

Culver City PD Policy Manual

Communications with Persons with Disabilities

337.12 REPORTING

Whenever any member of this department is required to complete a report or other documentation, and communication assistance has been provided, such services should be noted in the related report. Members should document the type of communication services utilized and whether the individual elected to use services provided by the Department or some other identified source. If the individual's express preference is not honored, the member must document why another method of communication was used.

All written communications exchanged in a criminal case shall be attached to the report or placed into evidence.

337.13 FIELD ENFORCEMENT

Field enforcement will generally include such contacts as traffic stops, pedestrian stops, serving warrants and restraining orders, crowd/traffic control and other routine field contacts that may involve individuals with disabilities. The scope and nature of these activities and contacts will inevitably vary.

The Department recognizes that it would be virtually impossible to provide immediate access to complete communication services to every member of this department. Members and/or supervisors must assess each situation and consider the length, complexity and importance of the communication, as well as the individual's preferred method of communication, when determining the type of resources to use and whether a qualified interpreter is needed.

Although not every situation can be addressed in this policy, it is important that members are able to effectively communicate the reason for a contact, the need for information and the meaning or consequences of any enforcement action. For example, it would be meaningless to verbally request consent to search if the officer is unable to effectively communicate with an individual who is deaf or hard of hearing and requires communications assistance.

If available, officers should obtain the assistance of a qualified interpreter before placing an individual with a disability under arrest. Individuals who are arrested and are assisted by service animals should be permitted to make arrangements for the care of such animals prior to transport.

337.13.1 FIELD RESOURCES

Examples of methods that may be sufficient for transactions, such as checking a license or giving directions to a location or for urgent situations such as responding to a violent crime in progress, may, depending on the circumstances, include such simple things as:

- (a) Hand gestures or visual aids with an individual who is deaf, hard of hearing or has impaired speech.
- (b) Exchange of written notes or communications.
- (c) Verbal communication with an individual who can speechread by facing the individual and speaking slowly and clearly.

Culver City Police Department

Culver City PD Policy Manual

Communications with Persons with Disabilities

- (d) Use of computer, word processing, personal communication device or similar device to exchange texts or notes.
- (e) Slowly and clearly speaking or reading simple terms to individuals who have a visual or mental impairment.

Members should be aware that these techniques may not provide effective communication as required by law and this policy depending on the circumstances.

337.14 CUSTODIAL INTERROGATIONS

In an effort to ensure that the rights of individuals who are deaf, hard of hearing or have speech impairment are protected during a custodial interrogation, this department will provide interpreter services before beginning an interrogation, unless exigent circumstances exist or the individual has made a clear indication that he/she understands the process and desires to proceed without an interpreter. The use of a video remote interpreting service should be considered, where appropriate, if a live interpreter is not available. *Miranda* warnings shall be provided to suspects who are deaf or hard of hearing by a qualified interpreter or by providing a written *Miranda* warning card.

In order to ensure that communications during custodial investigations are accurately documented and are admissible as evidence, interrogations should be recorded whenever reasonably possible. See guidance on recording custodial interrogations in the Investigation and Prosecution Policy.

337.15 ARREST AND BOOKINGS

If an individual with speech or hearing disabilities is arrested, the arresting officer shall use department-approved procedures to provide a qualified interpreter at the place of arrest or booking as soon as reasonably practicable, unless the individual indicates that he/she prefers a different auxiliary aid or service or the officer reasonably determines another effective method of communication exists under the circumstances.

When gathering information during the booking process, members should remain alert to the impediments that often exist when communicating with those who are deaf, hard of hearing, who have impaired speech or vision, are blind, or have other disabilities. In the interest of the arrestee's health and welfare, the safety and security of the facility and to protect individual rights, it is important that accurate medical screening and booking information be obtained. If necessary, members should seek the assistance of a qualified interpreter whenever there is concern that accurate information cannot be obtained or that booking instructions may not be properly understood by the individual.

Individuals who require and possess personally owned communication aids (e.g., hearing aids, cochlear processors) should be permitted to retain them while in custody.

Culver City Police Department

Culver City PD Policy Manual

Communications with Persons with Disabilities

337.16 COMPLAINTS

The Department shall ensure that individuals with disabilities who wish to file a complaint regarding members of this department are able to do so. The Department may provide a qualified interpreter or forms in enlarged print, as appropriate. Complaints will be referred to the Watch Commander.

Investigations into such complaints shall be handled in accordance with the Personnel Complaints Policy. Qualified interpreters used during the investigation of a complaint should not be members of this Department.

337.17 TRAINING

To ensure that all members who may have contact with individuals who are disabled are properly trained, the Department will provide periodic training that should include:

- (a) Awareness and understanding of this policy and related procedures, related forms and available resources.
- (b) Procedures for accessing qualified interpreters and other available resources.
- (c) Working with in-person and telephone interpreters and related equipment.

The Personnel and Training Lieutenant shall be responsible for ensuring new members receive training related to interacting with individuals who have disabilities, including individuals who are deaf, hard of hearing, who have impaired speech or vision, or are blind. Those who may have contact with such individuals should receive refresher training at least once every two years thereafter. The Personnel and Training Lieutenant shall maintain records of all training provided, and will retain a copy in each member's training file in accordance with established records retention schedules.

337.17.1 CALL-TAKER TRAINING

Emergency call-takers shall be trained in the use of TTY equipment protocols for communicating with individuals who are deaf, hard of hearing or who have speech impairments. Such training and information should include:

- (a) The requirements of the ADA and Section 504 of the Rehabilitation Act for telephone emergency service providers.
- (b) ASL syntax and accepted abbreviations.
- (c) Practical instruction on identifying and processing TTY or TDD calls, including the importance of recognizing silent TTY or TDD calls, using proper syntax, abbreviations and protocol when responding to TTY or TDD calls.
- (d) Hands-on experience in TTY and TDD communications, including identification of TTY or TDD tones.

Training should be mandatory for all Southbay RCC members who may have contact with individuals from the public who are deaf, hard of hearing or have impaired speech. Refresher training should occur every six months.

Mandatory Employer Notification

338.1 PURPOSE AND SCOPE

The purpose of this policy is to describe the requirements and procedures to follow when a public or private school employee (teacher and non-teacher) has been arrested under certain circumstances.

338.2 MANDATORY SCHOOL EMPLOYEE ARREST REPORTING

In the event a school employee is arrested for any offense enumerated below, the Chief of Police or his/her designee is required to report the arrest as follows.

338.2.1 ARREST OF PUBLIC SCHOOL TEACHER

In the event a public school teacher is arrested for any controlled substance offense enumerated in Health and Safety Code § 11591 or Health and Safety Code § 11364, in so far as that section relates to Health and Safety Code § 11054(d)(12), or for any of the offenses enumerated in Penal Code § 290, Penal Code § 261(a), or Education Code § 44010, the Chief of Police or his/her designee is mandated to immediately notify by telephone the superintendent of the school district employing the teacher and to immediately give written notice of the arrest to the Commission on Teacher Credentialing and to the superintendent of schools in the county where the person is employed (Health and Safety Code § 11591; Penal Code § 291).

338.2.2 ARREST OF PUBLIC SCHOOL NON-TEACHER EMPLOYEE

In the event a public school non-teacher employee is arrested for any controlled substance offense enumerated in Health and Safety Code § 11591 or Health and Safety Code § 11364, in so far as that section relates to Health and Safety Code § 11054(d)(12), or for any of the offenses enumerated in Penal Code § 290, Penal Code § 261(a), or Education Code § 44010, the Chief of Police or his/her designee is mandated to immediately notify by telephone the superintendent of the school district employing the non-teacher and to immediately give written notice of the arrest to the governing board of the school district employing the person (Health and Safety Code § 11591; Penal Code § 291).

338.2.3 ARREST OF PRIVATE SCHOOL TEACHER

In the event a private school teacher is arrested for any controlled substance offense enumerated in Health and Safety Code § 11591 or Health and Safety Code § 11364, in so far as that section relates to Health and Safety Code § 11054(d)(12), or for any of the offenses enumerated in Penal Code § 290 or Education Code § 44010, the Chief of Police or his/her designee is mandated to immediately notify by telephone the private school authority employing the teacher and to immediately give written notice of the arrest to the private school authority employing the teacher (Health and Safety Code § 11591; Penal Code § 291.1).

338.2.4 ARREST OF COMMUNITY COLLEGE INSTRUCTOR

In the event a teacher or instructor employed in a community college district school is arrested for any controlled substance offense enumerated in Health and Safety Code § 11591.5 or Health

Culver City Police Department

Culver City PD Policy Manual

Mandatory Employer Notification

and Safety § 11364, in so far as that section relates to Health and Safety Code § 11054(d)(9), or for any of the offenses enumerated in Penal Code § 290 or in Penal Code § 261(a)(1), the Chief of Police or the authorized designee is mandated to immediately notify by telephone the superintendent of the community college district employing the person, and shall immediately give written notice of the arrest to the California Community Colleges Chancellor's Office (Health and Safety Code § 11591.5; Penal Code § 291.5).

338.3 POLICY

The Culver City Police Department will meet the reporting requirements of California law to minimize the risks to children and others.

338.4 ARREST OF PERSONS EMPLOYED IN COMMUNITY CARE FACILITIES

In the event an employee of a community treatment facility, a day treatment facility, a group home, a short-term residential therapeutic program or a foster family agency is arrested for child abuse (as defined in Penal Code § 11165.6) and the employee is free to return to work where children are present, the investigating member shall notify the licensee of the charge of abuse (Health and Safety Code § 1522.2).

Biological Samples

339.1 PURPOSE AND SCOPE

This policy provides guidelines for the collection of biological samples from those individuals required to provide samples upon conviction or arrest for certain offenses. This policy does not apply to biological samples collected at a crime scene or taken from a person in conjunction with a criminal investigation. Nor does it apply to biological samples from those required to register, for example, sex offenders.

339.2 POLICY

The Culver City Police Department will assist in the expeditious collection of required biological samples from offenders in accordance with the laws of this state and with as little reliance on force as practicable.

339.2.1 ARRESTEES

Any adult arrested or charged with any felony offense is required to provide DNA samples. DNA samples should be collected immediately following arrest, or during the booking process, or as soon as administratively practicable after arrest but in any case prior to release on bail or other physical release from custody (Penal Code § 296.1(a)(1)(A)).

339.2.2 SEX AND ARSON REGISTRANTS

Any adult or juvenile who is required to register as a sex offender under Penal Code § 290 or arsonist under Penal Code § 457.1, including those whose registration resulted from a qualifying misdemeanor crime is required to submit a DNA sample. (Penal Code § 296(a)(3)).

At the time that any such registrant registers, updates registration, or is notified by the Department of Justice or other law enforcement officer, an appointment shall be made designating the time and place for the collection of DNA samples if no such sample has already been provided (Penal Code § 296.2(c)).

339.3 PERSONS SUBJECT TO DNA COLLECTION

Those who must submit a biological sample include (Penal Code § 296):

- (a) A person, including a juvenile, upon conviction or other adjudication of any felony offense.
- (b) A person, including a juvenile, upon conviction or other adjudication of any offense if the person has a prior felony on record.
- (c) An adult arrested or charged with any felony.

339.3.1 BLOOD SAMPLES

The withdrawal of blood may only be performed in a medically approved manner by health care providers trained and qualified to draw blood. Blood samples obtained for submission to the Department of Justice DNA lab shall be placed in Department of Justice blood vials (Penal Code § 298(a) and (b(2))).

Culver City Police Department

Culver City PD Policy Manual

Biological Samples

339.3.2 BUCCAL SWABS

Buccal swab samples (taken from the inside of the mouth) may only be procured by employees who have successfully completed departmentally approved training in the collection of buccal swabs and with the use of the California Department of Justice Livescan Buccal DNA Collection Kit. (Penal Code § 298(a) and (b)(3)). Subject's full name and CII# shall be placed on the collector.

(Note: If an individual violently resists or presents other officer safety issues, employees may omit buccal swab samples upon approval of a supervisor.)

339.3.3 FULL PALM PRINTS

Full palm print impressions shall be obtained on Department of Justice prescribed forms along with all DNA samples. (Penal Code § 298(b)(4)).

339.3.4 USE OF FORCE TO OBTAIN SAMPLES

If, after a written or oral request, a qualified individual refuses to provide any or all of the required DNA samples, a sworn member of this department may use reasonable force to obtain such sample(s) under the following conditions:

- (a) Prior to the use of reasonable force, the officer(s) shall take and document reasonable steps to secure voluntary compliance (Penal Code § 298.1(c)(1)(C)).
- (b) Prior to the use of reasonable force, the officer(s) shall obtain written authorization from a supervisor which shall minimally include that the individual was asked to provide the sample(s) and refused (Penal Code § 298.1(c)(1)(B)).
- (c) If the authorized use of reasonable force includes a cell extraction, such extraction shall be video recorded (Penal Code § 298.1(c)(1)(D)).

For the purpose of this section, the "use of reasonable force" shall be defined as the force that an objective, trained and competent officer faced with similar facts and circumstances would consider necessary and reasonable to gain compliance. (Penal Code § 298.1(c)(1)(A)).

339.4 PROCEDURE

When an individual is required to provide a biological sample, a trained employee shall obtain the sample in accordance with this policy.

339.4.1 COLLECTION

The following steps should be taken to collect a sample:

- (a) Verify that the individual is required to provide a sample pursuant to Penal Code § 296; Penal Code § 296.1.
- (b) Verify that a biological sample has not been previously collected from the offender by querying the individual's criminal history record for a DNA collection flag or, during regular business hours, calling the California Department of Justice (DOJ) designated DNA laboratory. There is no need to obtain a biological sample if one has been previously obtained.
- (c) Use a DNA buccal swab collection kit provided by the California DOJ to perform the collection and take steps to avoid cross contamination.

Culver City Police Department

Culver City PD Policy Manual

Biological Samples

339.4.2 FOLLOW UP NOTICE TO DOJ

Within two years of submitting any DNA specimen, sample or impression to the Department of Justice, this department shall notify DOJ whether the individual remains a suspect in a criminal investigation (Penal Code § 297(c)(2)). It shall be the responsibility of the Department of Justice to thereafter purge samples of any individual(s) who are no longer a suspect in any criminal investigation from the DNA database.

339.5 USE OF FORCE TO OBTAIN SAMPLES

If a person refuses to cooperate with the sample collection process, officers should attempt to identify the reason for refusal and seek voluntary compliance without resorting to using force. Force will not be used in the collection of samples except as authorized by court order and only with the approval of a supervisor. Methods to consider when seeking voluntary compliance include contacting:

- (a) The person's parole or probation officer when applicable.
- (b) The prosecuting attorney to seek additional charges against the person for failure to comply or to otherwise bring the refusal before a judge.
- (c) The judge at the person's next court appearance.
- (d) The person's attorney.
- (e) A chaplain.
- (f) Another custody facility with additional resources, where an arrestee can be transferred to better facilitate sample collection.
- (g) A supervisor who may be able to authorize custodial disciplinary actions to compel compliance, if any are available.

The supervisor shall review and approve any plan to use force and be present to document the process.

339.6 LITIGATION

The Chief of Police or authorized designee shall immediately notify the Department of Justice DNA Legal Unit at (415) 703-5892 in the event this department is named in a lawsuit involving the DNA Data Bank sample collection, sample use, or any aspect of the state's DNA Data Bank Program.

Child and Dependent Adult Safety

340.1 PURPOSE AND SCOPE

This policy provides guidelines to ensure that children and dependent adults are not left without appropriate care in the event their caregiver or guardian is arrested or otherwise prevented from providing care due to actions taken by members of this department (Penal Code § 833.2(a)).

This policy does not address the actions to be taken during the course of a child abuse or dependent adult investigation. These are covered in the Child Abuse and Senior and Disability Victimization policies.

340.2 POLICY

It is the policy of this department to mitigate, to the extent reasonably possible, the stressful experience individuals may have when their parent or caregiver is arrested. The Culver City Police Department will endeavor to create a strong, cooperative relationship with local, state and community-based social services to ensure an effective, collaborative response that addresses the needs of those affected, including call-out availability and follow-up responsibilities.

340.3 PROCEDURES DURING AN ARREST

When encountering an arrest or prolonged detention situation, officers should make reasonable attempts to determine if the arrestee is responsible for children or dependent adults. In some cases this may be obvious, such as when children or dependent adults are present. However, officers should inquire if the arrestee has caregiver responsibilities for any children or dependent adults who are without appropriate supervision. The following steps should be taken (Penal Code § 13517.7(b)(1)):

- (a) Inquire about and confirm the location of any children or dependent adults.
- (b) Look for evidence of children and dependent adults. Officers should be mindful that some arrestees may conceal the fact that they have a dependent for fear the individual may be taken from them.
- (c) Consider inquiring of witnesses, neighbors, friends and relatives of the arrestee as to whether the person is responsible for a child or dependent adult.

Whenever reasonably possible, officers should take reasonable steps to accomplish the arrest of a parent, guardian or caregiver out of the presence of his/her child or dependent adult. Removing children or dependent adults from the scene in advance of the arrest will generally ensure the best outcome for the individual.

Whenever it is safe to do so, officers should allow the parent or caregiver to assure children or dependent adults that they will be provided care. If this is not safe or if the demeanor of the parent or caregiver suggests this conversation would be non-productive, the officer at the scene should explain the reason for the arrest in age-appropriate language and offer reassurance to the child or dependent adult that he/she will receive appropriate care.

Culver City Police Department

Culver City PD Policy Manual

Child and Dependent Adult Safety

340.3.1 AFTER AN ARREST

Whenever an arrest is made, the officer should take all reasonable steps to ensure the safety of the arrestee's disclosed or discovered children or dependent adults.

Officers should allow the arrestee reasonable time to arrange for care of children and dependent adults. Temporary placement with family or friends may be appropriate. However, any decision should give priority to a care solution that is in the best interest of the child or dependent adult. In such cases the following guidelines should be followed:

- (a) Allow the person reasonable time to arrange for the care of children and dependent adults with a responsible party, as appropriate.
 - 1. Officers should consider allowing the person to use his/her cell phone to facilitate arrangements through access to contact phone numbers, and to lessen the likelihood of call screening by the recipients due to calls from unknown sources.
- (b) Unless there is evidence to the contrary (e.g., signs of abuse, drug use, unsafe environment), officers should respect the parent or caregiver's judgment regarding arrangements for care. It is generally best if the child or dependent adult remains with relatives or family friends that he/she knows and trusts because familiarity with surroundings and consideration for comfort, emotional state and safety are important.
 - 1. Except when a court order exists limiting contact, the officer should attempt to locate and place children or dependent adults with the non-arrested parent, guardian or caregiver.
- (c) Provide for the immediate supervision of children or dependent adults until an appropriate caregiver arrives.
- (d) Notify Child Protective Services or the Division of Aging and Adult Services, if appropriate.
- (e) Notify the field supervisor or Watch Commander of the disposition of children or dependent adults.

If children or dependent adults are at school or another known location outside the household at the time of arrest, the arresting officer should attempt to contact the school or other known location and inform the principal or appropriate responsible adult of the caregiver's arrest and of the arrangements being made for the care of the arrestee's dependent. The result of such actions should be documented in the associated report.

340.3.2 DURING THE BOOKING PROCESS

During the booking process the arrestee shall be allowed to make additional telephone calls to relatives or other responsible individuals as is reasonably necessary to arrange for the care of any child or dependent adult. These telephone calls should be given as soon as practicable and are in addition to any other telephone calls allowed by law (Penal Code § 851.5(c)).

Culver City Police Department

Culver City PD Policy Manual

Child and Dependent Adult Safety

If an arrestee is unable to resolve the care of any child or dependent adult through this process, a supervisor should be contacted to determine the appropriate steps to arrange for care. These steps may include additional telephone calls or contacting a local, county or state services agency.

340.4 DEPENDENT WELFARE SERVICES

Whenever an arrestee is unwilling or incapable of arranging for the appropriate care of any child or dependent adult, the handling officer should contact the appropriate welfare service or other department-approved social service to determine whether protective custody is appropriate (Welfare and Institutions Code § 305).

Only when other reasonable options are exhausted should a child or dependent adult be transported to the police facility, transported in a marked patrol car, or taken into formal protective custody.

Under no circumstances should a child or dependent adult be left unattended or without appropriate care.

340.5 TRAINING

The Personnel and Training Lieutenant is responsible to ensure that all personnel of this department who may be involved in arrests affecting children or dependent adults receive approved POST-approved training on effective safety measures when a parent, guardian or caregiver is arrested (Penal Code § 13517.7).

Service Animals

341.1 PURPOSE AND SCOPE

The purpose of this policy is to provide the guidelines necessary to ensure the rights of individuals who use service animals to assist with disabilities are protected in accordance with Title II of the Americans with Disabilities Act of 1990 (ADA).

341.1.1 DEFINITIONS

Definitions related to this policy include:

Service animal - A dog that is trained to do work or perform tasks for the benefit of an individual with a disability, including a physical, sensory, psychiatric, intellectual or other mental disability. The work or tasks performed by a service animal must be directly related to the individual's disability (28 CFR 35.104; Health and Safety Code § 113903).

Service animal also includes a miniature horse if the horse is trained to do work or perform tasks for people with disabilities, provided the horse is housebroken, is under the handler's control, the facility can accommodate the horse's type, size and weight, and the horse's presence will not compromise legitimate safety requirements necessary for safe operation of the facility (28 CFR 35.136(i)).

341.2 POLICY

It is the policy of the Culver City Police Department to provide services and access to persons with service animals in the same manner as those without service animals. Department members shall protect the rights of persons assisted by service animals in accordance with state and federal law.

341.3 IDENTIFICATION AND USE OF SERVICE ANIMALS

Some service animals may be readily identifiable. However, many do not have a distinctive symbol, harness or collar.

Service animals may be used in a number of ways to provide assistance, including:

- Guiding people who are blind or have low vision.
- Alerting people who are deaf or hard of hearing.
- Retrieving or picking up items, opening doors or flipping switches for people who have limited use of their hands, arms or legs.
- Pulling wheelchairs.
- Providing physical support and assisting with stability and balance.
- Doing work or performing tasks for persons with traumatic brain injury, intellectual disabilities or psychiatric disabilities, such as reminding a person with depression to take medication.
- Alerting a person with anxiety to the onset of panic attacks, providing tactile stimulation to calm a person with post-traumatic stress disorder, assisting people with

Culver City Police Department

Culver City PD Policy Manual

Service Animals

schizophrenia to distinguish between hallucinations and reality, and helping people with traumatic brain injury to locate misplaced items or follow daily routines.

341.4 MEMBER RESPONSIBILITIES

Service animals that are assisting individuals with disabilities are permitted in all public facilities and areas where the general public is allowed. Department members are expected to treat individuals with service animals with the same courtesy and respect that the Culver City Police Department affords to all members of the public (28 CFR 35.136).

341.4.1 INQUIRY

If it is apparent or if a member is aware that an animal is a service animal, the individual generally should not be asked any questions as to the status of the animal. If it is unclear whether an animal meets the definition of a service animal, the member should ask the individual only the following questions (28 CFR 35.136(f)):

- Is the animal required because of a disability?
- What task or service has the service animal been trained to perform?

If the individual explains that the animal is required because of a disability and has been trained to work or perform at least one task, the animal meets the definition of a service animal and no further questions as to the animal's status should be asked. The individual should not be questioned about his/her disability nor should the person be asked to provide any license, certification or identification card for the service animal.

341.4.2 CONTACT

Service animals are not pets. Department members should not interfere with the important work performed by a service animal by talking to, petting or otherwise initiating contact with a service animal.

341.4.3 REMOVAL

If a service animal is not housebroken or exhibits vicious behavior, poses a direct threat to the health of others, or unreasonably disrupts or interferes with normal business operations, an officer may direct the handler to remove the animal from the premises. Barking alone is not a threat nor does a direct threat exist if the person takes prompt, effective action to control the service animal (28 CFR 35.136(b)).

Each incident must be considered individually and past incidents alone are not cause for excluding a service animal. Removal of a service animal may not be used as a reason to refuse service to an individual with disabilities. Members of this department are expected to provide all services as are reasonably available to an individual with a disability, with or without a service animal.

341.4.4 COMPLAINTS

When handling calls of a complaint regarding a service animal, members of this department should remain neutral and should be prepared to explain the ADA requirements concerning service animals to the concerned parties. Businesses are required to allow service animals to accompany

Culver City Police Department

Culver City PD Policy Manual

Service Animals

their handlers into the same areas that other customers or members of the public are allowed (28 CFR 36.302).

Absent a violation of law independent of the ADA, officers should take no enforcement action beyond keeping the peace. Individuals who believe they have been discriminated against as a result of a disability should be referred to the Civil Rights Division of the U.S. Department of Justice (DOJ).

Volunteer Program

342.1 PURPOSE AND SCOPE

It is the policy of this department to use qualified volunteers for specified tasks and duties in order to create efficiencies for the Department and improve services to the community. Volunteers are intended to supplement and support, rather than supplant, sworn officers and civilian personnel. Volunteers are an important part of any organization and have proven to be a valuable asset to law enforcement agencies. Volunteers help to increase departmental responsiveness, delivery of services and data entry, and provide new program opportunities. In addition, volunteers bring new skills and expertise to the Department and prompt new enthusiasm.

342.1.1 DEFINITION OF VOLUNTEER

An individual who performs a service for the Department without promise, expectation or receipt of compensation for services rendered. This may include unpaid chaplains, unpaid reserve officers, interns, persons providing administrative support and youth involved in a law enforcement Explorer Post, among others.

342.2 VOLUNTEER MANAGEMENT

342.2.1 VOLUNTEER COORDINATOR

The Community Relations Management Analyst shall act as the Volunteer Coordinator. The function of the Volunteer Coordinator is to provide a central coordinating point for effective volunteer management within the Department, and to direct and assist staff and volunteer efforts to jointly provide more productive services. The Volunteer Coordinator should work with other Department staff on an ongoing basis to assist in the development and implementation of volunteer-staffed positions.

The Volunteer Coordinator, or his/her designee, shall be responsible for the following:

- (a) Recruiting, selecting and training qualified volunteers for various positions.
- (b) Facilitating the implementation of new volunteer activities and assignments.
- (c) Maintaining records for each volunteer.
- (d) Tracking and evaluating the contribution of volunteers.
- (e) Maintaining a record of volunteer schedules and work hours.
- (f) Completion and dissemination as appropriate of all necessary paperwork and information.

342.2.2 RECRUITMENT

Volunteers should be considered consistent with department policy on equal opportunity nondiscriminatory employment. A primary qualification for participation in the application process should be an interest in, and an ability to assist the Department in serving the public.

Culver City Police Department

Culver City PD Policy Manual

Volunteer Program

Requests for volunteers should be submitted in writing by interested staff to the Volunteer Coordinator through the requester's immediate supervisor. A complete position description and a requested time-frame should be included in the request. All parties should understand that the recruitment of volunteers is enhanced by creative and interesting assignments. The Volunteer Coordinator may withhold assignment of any volunteer until such time as the requesting unit is prepared to make effective use of volunteer resources.

342.2.3 SCREENING

All prospective volunteers should complete the volunteer application form. The Volunteer Coordinator or designee should conduct a face-to-face interview with an applicant under consideration.

A documented background investigation shall be completed on each volunteer applicant and shall include, but not necessarily be limited to, the following:

- (a) Traffic and criminal background check. Fingerprints shall be obtained from all applicants and processed through the California Criminal Information Index.
- (b) Employment
- (c) References
- (d) Confidential Database Certification

A polygraph exam may be required of each applicant depending on the type of assignment.

342.2.4 SELECTION AND PLACEMENT

Service as a volunteer with the Department shall begin with an official notice of acceptance or appointment to a volunteer position. Notice may only be given by an authorized representative of the Department, who will normally be the Volunteer Coordinator. No volunteer should begin any assignment until they have been officially accepted for that position and completed all required screening and paperwork. At the time of final acceptance, each volunteer should complete all required enrollment paperwork and will receive a copy of their position description and agreement of service with the Department. All volunteers shall receive a copy of the volunteer handbook and shall be required to sign a volunteer agreement.

Volunteers should be placed only in assignments or programs that are consistent with their knowledge, skills, abilities and the needs of the Department.

342.2.5 TRAINING

Volunteers will be provided with an orientation program to acquaint them with the Department, personnel, and policies/procedures that have a direct impact on their work assignment.

Volunteers should receive position-specific training to ensure they have adequate knowledge and skills to complete tasks required by the position and should receive periodic ongoing training as deemed appropriate by their supervisor or the Volunteer Coordinator.

Culver City Police Department

Culver City PD Policy Manual

Volunteer Program

Training should reinforce to volunteers that they may not intentionally represent themselves as, or by omission infer that they are sworn officers or other full-time members of the Department. They shall always represent themselves as volunteers.

All volunteers shall comply with the rules of conduct and with all orders and directives, either oral or written, issued by the Department.

342.2.6 FITNESS FOR DUTY

No volunteer shall report to work or be on-duty when his/her judgment or physical condition has been impaired by alcohol, medication, other substances, illness or injury.

Volunteers shall report to their supervisor any changes in status that may affect their ability to fulfill their duties. This includes, but is not limited to, the following:

- (a) Driver license
- (b) Medical condition
- (c) Arrests
- (d) Criminal investigations

All volunteers shall adhere to the guidelines set forth by this department regarding drug and alcohol use.

342.2.7 DRESS CODE

As representatives of the Department, volunteers are responsible for presenting a professional image to the community. Volunteers shall dress appropriately for the conditions and performance of their duties.

Volunteers shall conform to department-approved dress consistent with their duty assignment. Uniforms authorized for volunteers should be readily distinguishable from those worn by sworn officers and be in good order. The uniform or identifiable parts of the uniform shall not be worn while off-duty except volunteers may choose to wear the uniform while in transit to or from official department assignments or functions provided an outer garment is worn over the uniform shirt so as not to bring attention to the volunteer while he/she is off duty.

Volunteers shall be required to return any issued uniform or department property at the termination of service.

342.3 SUPERVISION OF VOLUNTEERS

Each volunteer who is accepted to a position with the Department must have a clearly identified supervisor who is responsible for direct management of that volunteer. This supervisor will be responsible for day-to-day management and guidance of the work of the volunteer and should be available to the volunteer for consultation and assistance.

A volunteer may be assigned as and act as a supervisor of other volunteers provided that the supervising volunteer is under the direct supervision of a paid staff member.

Culver City Police Department

Culver City PD Policy Manual

Volunteer Program

Functional supervision of volunteers is the responsibility of the supervisor in charge of the unit where the volunteer is assigned.

342.4 CONFIDENTIALITY

Volunteers should not have access to confidential information such as criminal histories or investigative files. Unless otherwise directed by a supervisor or departmental policy, all information shall be considered confidential. Only that information specifically identified and approved by authorized personnel shall be released. Confidential information shall be given only to persons who have a need and a right to know as determined by D.O.J. mandates, departmental policy and supervisory personnel.

Volunteers shall not address public gatherings, appear on radio or television, prepare any article for publication, act as correspondents to a newspaper or other periodical, release or divulge any information concerning the activities of the Department, or maintain that they represent the Department in such matters without permission from the proper department personnel.

342.5 PROPERTY AND EQUIPMENT

Volunteers will be issued an identification card. Any fixed and portable equipment issued by the Department shall be for official and authorized use only. Any property or equipment issued to a volunteer shall remain the property of the Department and shall be returned at the termination of their shift.

342.6 DISCIPLINARY PROCEDURES/TERMINATION

A volunteer may be removed from the volunteer program at the discretion of the Chief of Police or the Volunteer Coordinator. Volunteers have no property interests in their continued appointment. However, if a volunteer is removed for alleged misconduct, the volunteer will be afforded an opportunity solely to clear his/her name through a liberty interest hearing which shall be limited to a single appearance before the Chief of Police or authorized designee.

Volunteers may resign from volunteer service with the Department at any time. It is requested that volunteers who intend to resign provide advance notice of their departure and a reason for their decision.

342.6.1 EXIT INTERVIEWS

Exit interviews, where possible, should be conducted with volunteers who are leaving their positions. The interview should ascertain why the volunteer is leaving the position and solicit the volunteer's suggestions on improving the position.

Flag Flown at Half-Staff

343.1 PURPOSE AND SCOPE

This policy sets guidelines and describes when the National, State, and City Flags should be flown at half-staff.

343.1.1 PROCEDURE

From time to time the National, State and City Flags are displayed at half-staff. This is accomplished by first hoisting the flag to the peak and then lowering it to the half-staff position. The State and City flags should be lowered first with the National Flag being lowered last. No flag should ever be made to fly higher than the National Flag.

343.1.2 CIRCUMSTANCES PERMITTING THE FLAGS TO BE FLOWN AT HALF-STAFF

The flags shall only be flown at half-staff at the direction of the City Manager, Chief of Police, any Bureau Commander, or the on-duty Watch Commander, in compliance with this manual.

At the direction of the City Manager, Chief of Police, any Bureau Commander, or the on-duty Watch Commander, the flags will be flown at half-staff whenever any local, county, state or federal law enforcement officer dies in the line of duty within California.

Additionally, the City Manager or Chief of Police may authorize the flags to be flown at half-staff whenever any active duty or retired Culver City Police Officer dies, or other situations determined by the Chief of Police.

The flags will be flown at half-staff from the time of death to the interment.

At the direction of the City Manager or Chief of Police, the flags may be flown at half-staff in respect for other deaths or events.

Off-Duty Law Enforcement Actions

344.1 PURPOSE AND SCOPE

The decision to become involved in a law enforcement action when off-duty can place an officer as well as others at great risk and must be done with careful consideration. This policy is intended to provide guidelines for officers of the Culver City Police Department with respect to taking law enforcement action while off-duty.

344.2 POLICY

Initiating law enforcement action while off-duty is generally discouraged. Officers should not attempt to initiate enforcement action when witnessing crimes such as suspected intoxicated drivers, reckless driving or minor property crimes. Such incidents should be promptly reported to the appropriate law enforcement agency.

Officers are not expected to place themselves in unreasonable peril. However, any sworn member of this department who becomes aware of an incident or circumstance that he/she reasonably believes poses an imminent threat of serious bodily injury or death, or significant property damage may take reasonable action to minimize the threat.

When public safety or the prevention of major property damage requires immediate action, officers should first consider reporting and monitoring the activity and only take direct action as a last resort.

344.3 FIREARMS

Officers of this department may carry firearms while off-duty in accordance with federal regulations and department policy. All firearms and ammunition must meet guidelines as described in the department Firearms Policy. When carrying firearms while off-duty officers shall also carry their department-issued identification.

Officers should refrain from carrying firearms when consumption of alcohol or marijuana is likely or when the need to carry a firearm is outweighed by safety considerations. Firearms shall not be carried by any officer who has consumed an amount of an alcoholic beverage or taken any drugs or medications or any combination thereof that would tend to adversely affect the officer's senses or judgment.

344.4 AUTHORIZATION TO POSSESS FIREARMS BY PEACE OFFICERS, DEFERRED ACTION FOR CHILDHOOD ARRIVALS (DACA) RECIPIENTS

The Culver City Police Department has selected, trained, and hired qualified candidates who are in the United States under the Deferred Action for Childhood Arrivals (DACA) Immigration Policy. Department policy authorizes Officers to possess their duty weapons while both on and off-duty in California.

Pursuant to Department policy, and California Law, both on-duty and off-duty Officers have peace Officer authority as to a public offense committed or for which there is probable cause to believe a

Culver City Police Department

Culver City PD Policy Manual

Off-Duty Law Enforcement Actions

crime has been committed in their presence, and with respect to which there is immediate danger to person or property, or the escape of the perpetrator of the offense.

Culver City Police Department Officers who are in the United States pursuant to DACA have the authority to possess a firearm for use in the performance of their official duties or other law enforcement purpose. The firearm shall not be possessed or used for a non-law enforcement related purpose.

This policy does not allow for an Officer in the United States pursuant to DACA to possess or use a firearm other than in the performance of their official duties or other law enforcement purpose. This policy does not allow for the conversion of a firearm for personal use.

344.5 DECISION TO INTERVENE

There is no legal requirement for off-duty officers to take law enforcement action. However, should officers decide to intervene, they must evaluate whether the action is necessary or desirable, and should take into consideration the following:

- (a) The tactical disadvantage of being alone and the fact there may be multiple or hidden suspects.
- (b) The inability to communicate with responding units.
- (c) The lack of equipment, such as handcuffs, OC or baton.
- (d) The lack of cover.
- (e) The potential for increased risk to bystanders if the off-duty officer were to intervene.
- (f) Unfamiliarity with the surroundings.
- (g) The potential for the off-duty officer to be misidentified by other peace officers or members of the public.

Officers should consider waiting for on-duty uniformed officers to arrive, and gather as much accurate intelligence as possible instead of immediately intervening.

344.5.1 INTERVENTION PROCEDURE

If involvement is reasonably necessary the officer should attempt to call or have someone else call 9-1-1 to request immediate assistance. The dispatcher should be informed that an off-duty officer is on-scene and should be provided a description of the officer if possible.

Whenever practicable, the officer should loudly and repeatedly identify him/herself as an Culver City Police Department officer until acknowledged. Official identification should also be displayed.

344.5.2 INCIDENTS OF PERSONAL INTEREST

Officers should refrain from handling incidents of personal interest, (e.g., family or neighbor disputes) and should remain neutral. In such circumstances officers should call the responsible agency to handle the matter.

Culver City Police Department

Culver City PD Policy Manual

Off-Duty Law Enforcement Actions

344.5.3 PROFESSIONAL STAFF RESPONSIBILITIES

Professional Staff personnel should not become involved in any law enforcement actions while off-duty except to notify the local law enforcement authority and remain at the scene if safe and practicable.

344.5.4 OTHER CONSIDERATIONS

When encountering a non-uniformed officer in public, uniformed officers should wait for acknowledgement by the non-uniformed officer in case he/she needs to maintain an undercover capability.

344.6 REPORTING

Any off-duty officer who engages in any law enforcement activity, regardless of jurisdiction, shall notify the Watch Commander as soon as practicable. The Watch Commander shall determine whether a report should be filed by the employee.

Officers should cooperate fully with the agency having jurisdiction in providing statements or reports as requested or as appropriate.

Department Use of Social Media

345.1 PURPOSE AND SCOPE

This policy provides guidelines to ensure that any use of social media on behalf of the Department is consistent with the department mission.

This policy does not address all aspects of social media use. Specifically, it does not address:

- Personal use of social media by department members (see the Employee Speech, Expression and Social Networking Policy).
- Use of social media in personnel processes (see the Recruitment and Selection Policy).
- Use of social media as part of a criminal investigation, other than disseminating information to the public on behalf of this department (see the Investigation and Prosecution Policy).

345.1.1 DEFINITIONS

Definitions related to this policy include:

Social media - Any of a wide array of Internet-based tools and platforms that allow for the sharing of information, such as the department website or social networking services

345.2 POLICY

The Culver City Police Department may use social media as a method of effectively informing the public about department services, issues, investigations and other relevant events.

Department members shall ensure that the use or access of social media is done in a manner that protects the constitutional rights of all.

345.3 AUTHORIZED USERS

Only members authorized by the Chief of Police or the authorized designee may utilize social media on behalf of the Department. Authorized members shall use only department-approved equipment during the normal course of duties to post and monitor department-related social media, unless they are specifically authorized to do otherwise by their supervisors.

The Chief of Police may develop specific guidelines identifying the type of content that may be posted. Any content that does not strictly conform to the guidelines should be approved by a supervisor prior to posting.

Requests to post information over department social media by members who are not authorized to post should be made through the member's chain of command.

345.4 AUTHORIZED CONTENT

Only content that is appropriate for public release, that supports the department mission and conforms to all department policies regarding the release of information may be posted.

Examples of appropriate content include:

Culver City Police Department

Culver City PD Policy Manual

Department Use of Social Media

- (a) Announcements.
- (b) Tips and information related to crime prevention.
- (c) Investigative requests for information.
- (d) Requests that ask the community to engage in projects that are relevant to the department mission.
- (e) Real-time safety information that is related to in-progress crimes, geographical warnings or disaster information.
- (f) Traffic information.
- (g) Press releases.
- (h) Recruitment of personnel.

345.4.1 INCIDENT-SPECIFIC USE

In instances of active incidents where speed, accuracy and frequent updates are paramount (e.g., crime alerts, public safety information, traffic issues), the Public Information Officer or the authorized designee will be responsible for the compilation of information to be released, subject to the approval of the Incident Commander.

345.5 PROHIBITED CONTENT

Content that is prohibited from posting includes, but is not limited to:

- (a) Content that is abusive, discriminatory, inflammatory or sexually explicit.
- (b) Any information that violates individual rights, including confidentiality and/or privacy rights and those provided under state, federal or local laws.
- (c) Any information that could compromise an ongoing investigation.
- (d) Any information that could tend to compromise or damage the mission, function, reputation or professionalism of the Culver City Police Department or its members.
- (e) Any information that could compromise the safety and security of department operations, members of the Department, victims, suspects or the public.
- (f) Any content posted for personal use.
- (g) Any content that has not been properly authorized by this policy or a supervisor.

Any member who becomes aware of content on this department's social media site that he/she believes is unauthorized or inappropriate should promptly report such content to a supervisor. The supervisor will ensure its removal from public view and investigate the cause of the entry.

345.5.1 PUBLIC POSTING PROHIBITED

Department social media sites shall be designed and maintained to prevent posting of content by the public.

The Department may provide a method for members of the public to contact department members directly.

Culver City Police Department

Culver City PD Policy Manual

Department Use of Social Media

345.6 MONITORING CONTENT

The Administrations Bureau Commander will direct the Community Relations Officer responsible for the department's social media platforms to review, at least annually, the use of department social media and report back on, at a minimum, the resources being used, the effectiveness of the content, any unauthorized or inappropriate content and the resolution of any issues.

345.7 RETENTION OF RECORDS

The Administration Bureau Bureau Commander should work with the Custodian of Records to establish a method of ensuring that public records generated in the process of social media use are retained in accordance with established records retention schedules.

345.8 TRAINING

Authorized members should receive training that, at a minimum, addresses legal issues concerning the appropriate use of social media sites, as well as privacy, civil rights, dissemination and retention of information posted on department sites.

Gun Violence Restraining Orders

346.1 PURPOSE AND SCOPE

The purpose of this policy is to provide guidelines for petitioning and serving gun violence restraining orders and accounting for the firearms obtained pursuant to those orders (Penal Code § 18108).

346.1.1 DEFINITIONS

Definitions related to this policy include:

Gun violence restraining order - Civil restraining order prohibiting a named person from controlling, owning, purchasing, possessing, receiving, or otherwise having custody of any firearms or ammunition, including an ammunition magazine (Penal Code § 18100).

346.2 POLICY

It is the policy of the Culver City Police Department to petition for and serve gun violence restraining orders in compliance with state law and to properly account for firearms and ammunition obtained by the Department pursuant to such orders.

346.3 GUN VIOLENCE RESTRAINING ORDERS

An officer who reasonably believes a person is a present danger to self or another person by controlling, owning, purchasing, possessing, receiving, or otherwise having custody of a firearm may request permission from the officer's supervisor to petition the court for a gun violence restraining order.

Officers petitioning the court should use the forms established by the Judicial Council (Penal Code § 18105). The petition should describe the number, types, and locations of any firearms and ammunition that the officer believes to be possessed or controlled by the person (Penal Code § 18107). The petition should also describe why less-restrictive alternatives are ineffective or inadequate for the circumstances (Penal Code § 18125; Penal Code § 18150; Penal Code § 18175).

If it is not practical under the circumstances to submit a written petition, an officer may submit the petition electronically or orally request a temporary order (Penal Code § 18122; Penal Code § 18140).

346.3.1 ADDITIONAL CONSIDERATIONS

Officers should also consider requesting permission to petition the court for a gun violence restraining order (Penal Code § 18108):

- (a) When responding to a residence that is associated with a firearm registration or record.
- (b) When responding to any call or incident when a firearm is present or when one of the involved parties owns, possesses, or expresses an intent to acquire a firearm.
- (c) During a contact with a person exhibiting mental health issues, including suicidal thoughts, statements, or actions, if that person owns or possesses a firearm.

Culver City Police Department

Culver City PD Policy Manual

Gun Violence Restraining Orders

Officers should consider obtaining a mental health evaluation if the encounter involves a situation where there is a reasonable cause to believe that the person poses an immediate and present danger of causing personal injury to themselves or another person by having custody or control of a firearm or expresses intent to obtain a firearm (see the Mental Illness Commitments Policy) (Penal Code § 18108).

346.4 SERVICE OF GUN VIOLENCE RESTRAINING ORDERS

An officer serving any gun violence restraining order shall:

- (a) Verbally ask the subject of the order if he/she has any firearm, ammunition, or magazine in his/her possession or under his/her custody or control (Penal Code § 18160).
- (b) Request that any firearms or ammunition be immediately surrendered and issue a receipt for the surrendered items (Penal Code § 18120).
- (c) Take into temporary custody any firearm or other deadly weapon discovered in plain view or pursuant to consent or other lawful search (Penal Code § 18250).
- (d) Inform the restrained person of any scheduled hearing regarding the order (Penal Code § 18160).
- (e) Transmit the original proof of service form to the issuing court as soon as practicable but within one business day (Penal Code § 18115).
- (f) As soon as practicable, but by the end of his/her shift, submit proof of service to the Records Supervisor for prompt entry into the California Restraining and Protective Order System (Penal Code § 18115).
- (g) Provide a property receipt

The officer should also inform the restrained person that he/she is required, within 24 hours, to surrender to a law enforcement agency any other firearms and ammunition he/she owns or that are in his/her custody or control or sell them to a firearms dealer. This notification should be documented.

All firearms and ammunition collected shall be handled and booked in accordance with the Property and Evidence Policy.

346.4.1 TEMPORARY EMERGENCY GUN VIOLENCE RESTRAINING ORDERS

An officer requesting a temporary emergency gun violence restraining order shall (Penal Code § 18140):

- (a) For oral requests, sign a declaration under penalty of perjury reciting the oral statements provided to the judicial officer and memorialize the order of the court on the form approved by the Judicial Council.
- (b) Serve the order on the restrained person if the person can be reasonably located.
- (c) Forward a copy of the order to the Records Supervisor for filing with the court and appropriate databases.

Culver City Police Department

Culver City PD Policy Manual

Gun Violence Restraining Orders

346.5 SEARCH WARRANTS

If a person who has been served with a gun violence restraining order refuses to surrender any firearm or ammunition, the officer should consider whether to seek a search warrant. If a search warrant is to be obtained, the preparation and service of the search warrant shall be done in accordance with the Warrant Service Policy. Additionally, (Penal Code § 1542.5):

- (a) The officer serving the warrant shall take custody of any firearm or ammunition that is controlled, possessed or owned by the person who is the subject of the gun violence restraining order, including any discovered pursuant to the warrant, a consensual search or other lawful search.
- (b) If the location being searched is jointly occupied and the firearm or ammunition is owned by a person other than the restrained person, the firearm or ammunition should not be seized if the following conditions are met:
 - 1. The firearm or ammunition can be stored in a manner that does not allow the restrained person to have control or access.
 - 2. There is no evidence that the owner unlawfully possesses the firearm or ammunition.
- (c) If a locked gun safe belonging to someone other than the subject of a gun violence restraining order is discovered, the officer shall not search the contents of the safe unless the owner consents or there is a valid search warrant for the safe. Any search of the safe must be done in the owner's presence.

346.6 RECORDS SUPERVISOR RESPONSIBILITIES

The Records Supervisor is responsible for ensuring:

- (a) Proof of service of any gun violence restraining order served by an officer or received from the clerk of the court is entered in the computer database system for protective and restraining orders maintained by the Department of Justice within one business day of service if served by an officer, or within one business day of receipt of proof of service if served by a person other than a law enforcement officer (Penal Code § 18115).
- (b) Temporary orders are entered into the California Restraining and Protective Order System (Penal Code § 18140).
- (c) Copies of temporary orders are filed with the court as soon as practicable, but no later than three court days, after issuance (Penal Code § 18140).
- (d) Copies of receipts of surrendered firearms or ammunition issued by other agencies for gun violence restraining orders issued by the Department are properly maintained (Penal Code § 18120).
- (e) Any relinquishment of firearm rights form received from the court is entered into the California Restraining and Protective Order System within one business day of receipt (Penal Code § 18115).

Culver City Police Department

Culver City PD Policy Manual

Gun Violence Restraining Orders

346.7 COURT-ORDERED FIREARMS AND AMMUNITION SURRENDERS

Authorized members shall accept firearms and ammunition from any individual who is the subject of a gun violence restraining order. The member receiving any firearm or ammunition shall:

- (a) Record the individual's name, address and telephone number.
- (b) Record the serial number of the firearm.
- (c) Prepare an incident report and property report.
- (d) Provide a property receipt to the individual who surrendered the firearms and ammunition.
- (e) Package and submit the firearms and ammunition in accordance with the Property and Evidence Policy.

346.8 STORAGE AND RELEASE OF FIREARMS AND AMMUNITION

Firearms and ammunition that were taken into temporary custody or surrendered pursuant to a gun violence restraining order shall be stored in accordance with the Property and Evidence Policy.

Firearms and ammunition shall be returned to the restrained person upon the expiration of the order in accordance with Penal Code § 18120 and the Property and Evidence Policy (Penal Code § 18108).

346.9 GUN VIOLENCE RESTRAINING ORDER COORDINATOR

The Chief of Police will appoint a gun violence restraining order coordinator. The responsibilities of the coordinator include:

- (a) Developing and maintaining procedures for the filing of a petition for an order or a renewal of an order by department members, also including procedures for requesting and serving (Penal Code § 18108):
 1. A temporary emergency gun violence restraining order.
 2. An ex parte gun violence restraining order.
 3. A gun violence restraining order issued after notice and hearing.
 4. Renewal orders.
- (b) Developing and maintaining factors to consider when assessing the need to seek an order, including (Penal Code § 18108; Penal Code § 18155):
 1. Whether threats have been made, and if so, whether the threats are credible and specific.
 2. Whether the potential victim is within close proximity.
 3. Whether the person has expressed suicidal tendencies.
 4. Whether the person has access to firearms.
 5. The criminal history of the person, in particular any history of criminal violence, including whether the person is currently on parole, probation, or monitored release.

Culver City Police Department

Culver City PD Policy Manual

Gun Violence Restraining Orders

6. The mental health history of the person, in particular whether the person has any history of mental illness or has ever been detained for being a danger to themselves or others.
 7. Any upcoming holidays, anniversaries, or other dates of significance that may serve as a trigger for the person, such as the death of a family member.
 8. Whether the person has any history of drug or alcohol abuse.
- (c) Developing and maintaining procedures for the receipt and service of orders consistent with the requirements of Penal Code § 18115; Penal Code § 18120; Penal Code § 18135; Penal Code § 18140; and Penal Code § 18160. Procedures should include:
1. Evaluation of an order to determine appropriate service and necessary precautions (see the Warrant Service Policy and the Operations Planning and Deconfliction Policy).
 2. Forwarding orders to the Records Supervisor for recording in appropriate databases and required notice to the court, as applicable.
 3. Preparing or obtaining a search warrant prior to attempting service of an order, when appropriate (Penal Code § 18108).
 4. Seizure procedures of firearms and ammunition at the time of issuance of a temporary emergency gun violence restraining order.
 5. Verification procedures for the removal of firearms and ammunition from the subject of a gun violence restraining order (Penal Code § 18108).
- (d) Coordinating with the Personnel and Training Lieutenant to provide officers who may be involved in petitioning for or serving orders with training on such orders. Training should include determining when a petition is appropriate, the process for seeking an order, and the service of such orders.
- (e) Reviewing each petition and any associated court documents for an order prepared by members, for compliance with this policy, department procedures, and state law.
- (f) Developing and maintaining procedures for members to accept voluntarily surrendered prohibited items at times other than when an order is being served by the Department.
1. Procedures should include preparing and providing a receipt identifying all prohibited items to the person surrendering the items.
- (g) Coordinating review of notices of court hearings and providing notice to the appropriate officer of the hearing date and the responsibility to appear and participate in the evidence presentation process (Penal Code § 18108).
- (h) Coordinating with the Personnel and Training Lieutenant to ensure officers remain current with the following (Penal Code § 18108):
1. Types of evidence a court considers when determining whether grounds exist for the issuance of a gun violence restraining order as provided in Penal Code § 18155 (Grounds for gun violence restraining order; examination by court).

Culver City Police Department

Culver City PD Policy Manual

Gun Violence Restraining Orders

2. The different procedures and protections afforded by different types of firearm-prohibiting emergency protective orders that are available to law enforcement petitioners.
 - (i) Establishing standards and procedures for addressing violations of a gun violence restraining order (Penal Code § 18108).
 - (j) Establishing procedures for officers to provide information about mental health referral services during contact with persons exhibiting mental health issues (Penal Code § 18108).

346.10 RENEWAL OF GUN VIOLENCE RESTRAINING ORDERS

The Detective Bureau supervisor is responsible for the review of a gun violence restraining order (including temporary or ex parte orders) obtained by the Department to determine if renewal should be requested within the time prescribed by law (Penal Code § 18190).

346.11 POLICY AVAILABILITY

The Chief of Police or the authorized designee shall be responsible for making this policy available to the public upon request (Penal Code § 18108).

346.12 TRAINING

The Personnel and Training Lieutenant should ensure that members receive periodic training on the requirements of this policy (Penal Code § 18108).

Community Relations

347.1 PURPOSE AND SCOPE

The purpose of this policy is to provide guidelines for community relationship-building.

Additional guidance on community relations and outreach is provided in other policies, including:

- Hate Crimes Policy.
- Limited English Proficiency Services Policy.
- Communications with Persons with Disabilities Policy
- Patrol Function Policy.
- Suspicious Activity Reporting Policy.

347.2 POLICY

It is the policy of the Culver City Police Department to promote positive relationships between members the department and the community by treating community members with dignity and respect and engaging them in public safety strategy development and relationship-building activities, and by making relevant policy and operations information available to the community in a transparent manner.

347.3 MEMBER RESPONSIBILITIES

Officers should, as time and circumstances reasonably permit:

- (a) Make casual and consensual contacts with community members to promote positive community relationships (see the Detentions and Photographing Detainees Policy).
- (b) Become reasonably familiar with the schools, businesses and community groups in their assigned jurisdictional areas.
- (c) Work with community members and the department community relations coordinator to identify issues and solve problems related to community relations and public safety.
- (d) Conduct periodic foot patrols of their assigned areas to facilitate interaction with community members. Officers carrying out foot patrols should notify an appropriate supervisor and Southbay RCC of their status (i.e., on foot patrol) and location before beginning and upon completion of the foot patrol. They should also periodically inform Southbay RCC of their location and status during the foot patrol.

347.4 COMMUNITY RELATIONS LIEUTENANT

The Chief of Police or the authorized designee should designate a member of the Department to serve as the community relations lieutenant . He/she should report directly to the Chief of Police or authorized designee and is responsible for:

- (a) Obtaining department-approved training related to his/her responsibilities.

Culver City Police Department

Culver City PD Policy Manual

Community Relations

- (b) Responding to requests from department members and the community for assistance in identifying issues and solving problems related to community relations and public safety.
- (c) Organizing surveys to measure the condition of the department's relationship with the community.
- (d) Working with community groups, department members and other community resources to:
 - 1. Identify and solve public safety problems within the community.
 - 2. Organize programs and activities that help build positive relationships between department members and the community and provide community members with an improved understanding of department operations.
- (e) Working with the Operations Bureau Commander to develop patrol deployment plans that allow officers the time to participate in community engagement and problem-solving activities.
- (f) Recognizing department and community members for exceptional work or performance in community relations efforts.
- (g) Attending City council and other community meetings to obtain information on community relations needs.
- (h) Assisting with the department's response to events that may affect community relations, such as an incident where the conduct of a department member is called into public question.
- (i) Informing the Chief of Police and others of developments and needs related to the furtherance of the department's community relations goals, as appropriate.

347.5 PARTNERSHIP IN POLICING (PIP)

The Partnership in Policing (PIP) Team was designed to have a diverse group of Police Officers at the forefront of continuing to foster, and enhance, the community partnerships.

This team is comprised of five (5) officers and one (1) sergeant. Their focus should be on the following:

- Providing a personalized police service to the community through collaboration with various entities.
- Enhanced focus in addressing quality of life issues
- Continued participation in community outreach events.
- Attendance of Neighborhood Watch Meetings.
- Working along-side the Community Relations Lieutenant.

Each of the five PIP Team Officers will serve as District Liaisons for each of the City's five (5) districts. This will allow each respective PIP Team officer to gain a more intimate knowledge of the different neighborhoods within these given districts, as well as any possible issues facing those neighborhoods.

Culver City Police Department

Culver City PD Policy Manual

Community Relations

347.6 COMMUNITY AND YOUTH ACTIVITIES AND PROGRAMS

The community relations lieutenant should organize or assist with programs and activities that create opportunities for department members and community members, especially youth, to interact in a positive setting. Examples of such programs and events include:

- (a) The Culver City Police Explorers program.
- (b) Police-community get-togethers (e.g., cookouts, meals, charity events).
- (c) Youth leadership and life skills mentoring.
- (d) School resource officer/Drug Abuse Resistance Education (D.A.R.E.®) programs.
- (e) Neighborhood Watch and crime prevention programs.

347.7 INFORMATION SHARING

The community relations lieutenant should develop methods and procedures for the convenient sharing of information (e.g., major incident notifications, significant changes in department operations, comments, feedback, positive events) between the Department and community members. Examples of information-sharing methods include:

- (a) Community meetings.
- (b) Social media (see the Department Use of Social Media Policy).
- (c) Department website postings.

Information should be regularly refreshed, to inform and engage community members continuously.

347.8 LAW ENFORCEMENT OPERATIONS EDUCATION

The community relations lieutenant should develop methods to educate community members on general law enforcement operations so they may understand the work that officers do to keep the community safe. Examples of educational methods include:

- (a) Development and distribution of informational cards/flyers.
- (b) Department website postings.
- (c) Instruction in schools.
- (d) Department ride-alongs (see the Ride-Along Policy).
- (e) Scenario/Simulation exercises with community member participation.
- (f) Youth internships at the Department.
- (g) Citizen academies.

Instructional information should include direction on how community members should interact with the police during enforcement or investigative contacts and how community members can make a complaint to the department regarding alleged misconduct or inappropriate job performance by department members.

Culver City Police Department

Culver City PD Policy Manual

Community Relations

347.9 SAFETY AND OTHER CONSIDERATIONS

Department members responsible for community relations activities should consider the safety of the community participants and, as much as reasonably practicable, not allow them to be present in any location or situation that would jeopardize their safety.

Department members in charge of community relations events should ensure that participating community members have completed waiver forms before participation, if appropriate. A parent or guardian must complete the waiver form if the participating community member has not reached 18 years of age.

Community members are subject to a criminal history check before approval for participation in certain activities, such as citizen academies.

347.10 TRANSPARENCY

The Department should periodically publish statistical data and analysis regarding the department's operations. The reports should not contain the names of officers, suspects or case numbers. The community relations lieutenant should work to identify information that may increase transparency regarding department operations.

347.11 TRAINING

Subject to available resources, members should receive training related to this policy, including training on topics such as:

- (a) Effective social interaction and communication skills.
- (b) Cultural, racial and ethnic diversity and relations.
- (c) Building community partnerships.
- (d) Community policing and problem-solving principles.
- (e) Enforcement actions and their effects on community relations.

Where practicable and appropriate, community members, especially those with relevant expertise, should be involved in the training to provide input from a community perspective.

Peer Support and Assistance Program

348.1 PURPOSE AND SCOPE

The Culver City Police Department recognizes the value of providing an "in-house" resource for employees and their family members to support them in managing both professional and personal crisis. The purpose of this policy is to establish an "in-house" Peer Support and Assistance Program and create a Peer Support Team for Department employees and their families.

The Peer Support Team may work in cooperation with peer support teams of other agencies and/or City Departments in multi-agency and/or multi-department incidents. The Peer Support Team may also be utilized to support the community in situations of critical incidents, such as school shootings, natural disasters, etc.

348.2 DEFINITION

The Peer Support Program is a program that offers assistance and appropriate support resources to employees when personal or professional problems negatively affect their work performance, family unit or self. This communication is confidential, providing it does not violate any law or Department regulation. This program is designed to:

- (a) Provide emotional support during and after times of personal or professional crisis to other employees who need assistance;
- (b) Promote trust, allow anonymity, and preserve confidentiality for persons using Peer Support within the guidelines of the program;
- (c) Develop members who can identify personal conflicts and provide guidance or referrals to professional/alternate resources as required;
- (d) Maintain an effective peer support training and response program;
- (e) Check on the well-being of employees out with illnesses / IOD's and provide support where desired and needed.

348.3 MISSION STATEMENT

The role of the Culver City Police Department Peer Support Team is to be available to listen, support, refer, and assist employees and family members during professional or personal, stressful, or difficult periods in their lives.

348.3.1 ACCESSING PEER SUPPORT

The Peer Support Team is available 24 hours a day, 7 days a week to all employees. There are Peer Support Team brochures available at several locations, including the briefing and report writing rooms, with team member contact information included. Peer Support Members can be contacted via the Peer Support App (Cordico).

348.3.2 POLICY

The Peer Support Team is intended to be a resource available to the Department in the event of a critical incident or crisis situation. Peer Support personnel will be available to:

Culver City Police Department

Culver City PD Policy Manual

Peer Support and Assistance Program

- (a) Listen to another employee's feelings after a critical incident or crisis situation;
- (b) Facilitate or assist supervisors in defusing critical incidents;
- (c) Respond to an employee's request for peer support or assistance;
- (d) Conduct Critical Incident Stress Management (CISM) debriefings;
- (e) Provide information on other resources available (Employee Assistance Program, Alcoholics Anonymous, financial support, etc.)
- (f) Provide Peer Support orientation to new employees (FTO program)
Personnel who may possibly be involved in conducting any administrative or criminal investigation or administrative discipline related to an employee seeking assistance shall avoid any conflict of interest.

Peer Support personnel shall also be available for support and assistance on any other incident at the discretion of the Chief of Police or Assistant Chief of Police.

348.3.3 CRITICAL INCIDENTS

A "Critical Incident" is any event that causes an unusually intense stress reaction. The distress people experience after a critical incident limits their ability to cope, impairs their ability to adjust, and negatively impacts the work environment.

Critical Incidents that may require a Peer Support response may include, but are not limited to:

- (a) Officer involved shootings;
- (b) Where an employee witnesses another employee's death or serious injury;
- (c) Where an employee is taken hostage;
- (d) Where an employee is a witness to a suicide;
- (e) Where an employee is a witness to a violent death or serious injury;
- (f) Infant/child death
- (g) Any incident that is likely to affect the employee's ability to interact with the public and carry out their job functions;
- (h) Any other incident deemed appropriate by any employee and approved by a supervisor.

348.3.4 DEBRIEFING/DEFUSING

Debriefings and defusing will be conducted by Peer support personnel as soon as practicable after a critical incident. Debriefings should occur within 24-72 hours after the critical incident and will be conducted by qualified personnel. Attendance at debriefings is highly recommended for all employees involved in the critical incident.

A defusing immediately follows the critical event and generally lasts no longer than one hour. It gives all parties involved in the incident the "Big Picture" of what occurred. It gives involved personnel a reminder about exercise, what foods to eat, to drink plenty of water and to know their thoughts are normal. Peer Support Team members may be present to give assistance and support. A defusing may eliminate the need for a formal debriefing or it may enhance the formal

Culver City Police Department

Culver City PD Policy Manual

Peer Support and Assistance Program

debriefing process. The Peer Support Coordinator and Program Advisor will decide on the need for a formal debriefing.

One certified CISM mental health professional and two to three Peer Support Team members are required to conduct a debriefing. The debriefing may last two to four hours.

348.4 CONFIDENTIALITY

The acceptance and success of the Culver City Police Department Peer Support and Assistance Program will be determined in part by the observance of confidentiality. It is imperative each Peer Support Team Member maintain strict confidentiality of all information learned that an individual within the guidelines of this program.

All conversations between Peer Support personnel and employees are not privileged communications under the Evidence Code. The department will respect the confidentiality of conversations between Peer Support personnel and employees, with the following exceptions:

- (a) Information concerning the commission of a crime;
- (b) The employee or a third party is a danger to themselves or to others.

Disclosures under this exception will be made directly to the Chief of Police or Assistant Chief of Police.

348.4.1 TEAM STRUCTURE

The Peer Support Program will fall under the Administration Bureau for budget and accountability purposes.

Program Coordinators - The Program Coordinator(s) should be the rank of Sergeant or higher. The Program Coordinators shall be responsible for the Peer Support Program budget and coordination of the Peer Support Team.

Program Advisor - The Program Advisor will be a licensed Forensics Psychologist with exceptional experience dealing with police and/or first responder issues. His/her duties shall consist of:

- (a) Assist in training and selection of Peer Support Team Members;
- (b) Provide continued training in the techniques of Peer counseling;
- (c) Provide guidance at debriefings.

Peer Support Team Members - Peer Support Team Members shall be selected from Department personnel at large.

348.5 ROLE OF PEER SUPPORT TEAM MEMBERS

Peer Support Team Members provide support and assistance to employees in times of stress and crisis. The responsibilities of a Peer Support Team Member are as follows:

- (a) Convey trust and anonymity and assure confidentiality within the policy to employees who seek assistance from the Peer Support Program;
- (b) Attend assigned Peer Support training seminars;

Culver City Police Department

Culver City PD Policy Manual

Peer Support and Assistance Program

- (c) Provide assistance and support;
- (d) Assist the employee by referring them to the appropriate outside resource when necessary;
- (e) Be available to employees for additional follow-up support;
- (f) Maintain contact with the Program Coordinators regarding program activities;
- (g) Attend quarterly meetings;
- (h) Agree to be contacted and if necessary, respond at any hour to assist an employee in need.

348.6 PAY AND COMPENSATION

When members of the Peer Support Team are notified to respond or attend a debriefing, the following pay and compensation policies will be in effect. Whenever possible, overtime will be pre-approved by the Program Coordinator(s).

- (a) If the personnel are "on-duty" they will be paid as Hours Worked;
- (b) If the personnel are "off-duty" they will submit an overtime slip to their immediate supervisor after the slip has been verified by the Program Coordinator or their designee; all overtime will be pre-approved by the Program Coordinators.
- (c) The pay/compensation will be the same as the guidelines set forth in the applicable Memorandum of Understanding for that Team Member;
- (d) There is no pay/compensation for being on the call-out roster.
- (e) Selection of members to the Peer Support team is not considered a special assignment.
- (f) Members of the Peer Support Team are considered "At Will" and can be removed by the Program Coordinators.

Generally, when an employee is on duty, meetings and follow-up contacts by a Peer Support Team Member will be coordinated with that employee's immediate supervisor. Consideration should be given to the employee's position, minimum staffing levels, calls for service and availability to attend meetings.

348.7 TRAINING

Peer Support Team Members should receive training in the following areas:

- (a) Effective listening;
- (b) Critical incident stress;
- (c) Debriefing and defusing techniques;
- (d) Post-traumatic stress;
- (e) Problem-solving skills;
- (f) Relationship termination;
- (g) General assessment skills;

Culver City Police Department

Culver City PD Policy Manual

Peer Support and Assistance Program

- (h) Referral follow-up.

The suggested minimum training is:

- (a) 24 Hour Basic Peer Support Course;
- (b) Basic Critical Incident Stress Management (CISM) course;
- (c) Any additional training as deemed necessary by the Chief of Police, Program Coordinators or Program Advisor.

In addition, The California Peer Support Association offers a training conference each year. A selected number of members may be budgeted to attend each year. Those in attendance shall provide training for team members unable to attend. Peer Support Team Members should attend on-going training to stay current on the latest practices and procedures for assistance to employees.

Unmanned Aerial Vehicles (UAV) Operations

349.1 PURPOSE AND SCOPE

The purpose of this policy is to establish guidelines for the use of an unmanned aerial vehicle (UAV) and for the storage, retrieval, and dissemination of images and data captured by the unmanned aircraft system.

Unmanned aerial systems may be utilized to enhance the City and Police Department's mission of protecting lives and property when other means and resources are not available or are less effective. Any use of a UAV will be in strict accordance with Federal Aviation Administration (FAA) regulations, as well as in accordance with the Culver City Police Department's FAA Certificate of Authorization.

The use of an unarmed aircraft system potentially involves privacy considerations, and this policy articulates the restrictions that are in place to protect the privacy rights of the general public that exist under the state and federal Constitutions and under state and federal law.

349.2 DEFINITIONS

Definitions related to this policy include:

Federal Aviation Administration (FAA) – The national aviation authority of the United States, with powers to regulate all the aspects of American aviation.

Unmanned Aerial Vehicle (UAV) – An unmanned aircraft of any type that is capable of sustaining directed flight, whether preprogrammed or remotely controlled.

Unmanned Aircraft System (UAS) – An unmanned aerial vehicle and all of the supporting or attached systems designed for gathering information through imaging, recording and any other means.

Recorded Media – Audio and video signals recorded or digitally stored on a storage device or portable media.

First Person View – A monitor used by the pilot in order to view the live video being received from the UAV. First person view is required in order for the UAV to fly outside of the visual line-of-sight of the pilot and the view of the visual observer.

Pilot – Any member of this Department capable of piloting a UAV.

Observer – Ground-based observers will assist with the operations and will assist the pilot to utilize the "see and avoid" technique by scanning the area for air traffic or possible hazards.

UAV Manager- Lieutenant in charge of managing all aspects of the UAV program. The UAV manager will be the Traffic Section Lieutenant.

Culver City Police Department

Culver City PD Policy Manual

Unmanned Aerial Vehicles (UAV) Operations

349.3 POLICY OBJECTIVES

It is the intent of the Culver City Police Department to use UAVs to effectively fulfill the Department's mission and to ensure these systems are used securely and efficiently. The use of the UAV systems is intended to accomplish the following:

- Record incidents for criminal and civil investigations, for investigation of personnel complaints, for audit review and officer training;
- Vividly replay those incidents for prosecutors and courts, thereby increasing rates of convictions of violations of the law; and
- Improve Departmental accountability, transparency, and preserve public trust.

349.4 PERMISSIVE USES OF UAV

UAV deployment will be considered when an aerial view would assist officers or incident commanders during the following types of occurrences:

- (a) Barricaded Suspects
- (b) Active Shooter/ Mass Casualty Incidents
- (c) Hostage Situations
- (d) Crime Scene Investigations
- (e) Critical Missing Persons Investigations
- (f) Search & Rescue Operations
- (g) Fires
- (h) Disaster Management
- (i) CBRNE Incident (chemical, biological, radiological, nuclear, and explosive)
- (j) Supporting Search and Arrest Warrant Operations
- (k) Perimeter Searches for Armed and/or Felony Suspects
- (l) Routine Training (public places)

Requests to deploy the UAV shall be approved by the on-duty Watch Commander, supervisor on the scene, or the UAV Manager prior to accepting the mission.

All UAV deployments will be documented on a supervisor or Watch Commander's daily log and recorded in a manner described in this policy.

349.5 PROHIBITED OR RESTRICTED USES OF UAV

The following includes but is not limited to circumstances under which UAV use shall either be prohibited or restricted:

- (a) The UAV video surveillance equipment shall not be used to conduct random surveillance activities.
- (b) The UAV video surveillance equipment shall not be used to target a person based solely on individual characteristics, such as, but not limited to race, ethnicity, national

Culver City Police Department

Culver City PD Policy Manual

Unmanned Aerial Vehicles (UAV) Operations

origin, immigration status, religion, political affiliation, disability, gender or sexual orientation.

- (c) The UAV shall not be weaponized, which means no firearms or weapons of any kind, either lethal or nonlethal, shall be connected to the UAV.
- (d) The UAV shall not be equipped with any type of facial recognition technology.
- (e) Use of vision enhancement technology (e.g., thermal or other imaging equipment not generally available to the public) is permissible in viewing areas only where there is no expectation of privacy, when in compliance with a search warrant or court order, or when exigent circumstances exist.
- (f) The UAV shall not be used to record non-work-related activity.
- (g) The UAV shall not be utilized outside of the manufacturer's recommended guidelines or when weather conditions would make flying the UAV unsafe.
- (h) When utilizing a UAV, pilots shall be sensitive to the dignity of all individuals being recorded. Pilots are to utilize sound judgment and exercise discretion when the respect for privacy indicates that discontinuing video recording is prudent because it reasonably appears to the pilot that such privacy may outweigh any legitimate law enforcement interest in the recording. Unless the circumstances no longer fit the criteria for recording under this policy, recording should resume when privacy is no longer at issue.

Requests by members of the public to stop recording should be considered using the activation criteria described in this policy. If the pilot believes the contact remains both legal and consistent with the activation criteria, the pilot shall continue to record the incident.

Absent a warrant or exigent circumstances, pilots and observers shall adhere to FAA altitude regulations and shall take reasonable precautions to avoid inadvertently recording or transmitting images of a person or any location where a person would have a reasonable expectation of privacy (e.g., residence, yard, enclosure). Reasonable precautions may include, for example, deactivating or turning imaging devices away from such areas or person during UAV operations.

349.6 OPERATIONS AND TRAINING

349.6.1 ELIGIBLE PILOTS

Only authorized personnel who have completed the required training and possess a valid license to operate UAVs issued by the FAA shall be permitted to operate the UAV.

349.6.2 PILOT TRAINING AND CERTIFICATION

All members within the unit that will act as a pilot shall be trained and maintain proficiency in their operator abilities. Each pilot shall be certified as a licensed Part 107 operator in accordance with current FAA requirements and standards. The pilot shall receive training on the operation and basic maintenance/upkeep of all components used during the operation of the UAS.

Culver City Police Department

Culver City PD Policy Manual

Unmanned Aerial Vehicles (UAV) Operations

In addition to the rules and requirements specified by the FAA, all UAV pilots shall perform quarterly training flights which will include takeoffs, landings and operating the video system and equipment.

- (a) All training flights which are held in public places within Culver City shall be announced utilizing Nixle/Everbridge and or other Department social media outlets. Every effort should be made to make these announcements seven days prior to the training and the announcements shall contain the date, time, and location of the training.

349.6.3 DUTIES OF A PILOT

The pilot's primary duty is the safe and effective operation of the Culver City Police Department's UAS.

349.6.4 USE OF FIRST PERSON VIEW

Only when officer and or public safety is a concern may a pilots solely utilize the first-person view while operating the UAV.

349.6.5 FLIGHT ALTITUDE AND SPEED

Pilots shall operate the UAV at a safe altitude and in a manner that maintains the safety and safeguards the privacy of the non-participating community. UAV pilots shall adhere to all applicable FAA rules and regulations, including but not limited to:

- (a) The ground speed of the UAV may not exceed 87 knots (100 miles per hour).
- (b) The altitude of the small unmanned aircraft cannot be higher than 400 feet above ground level, unless the small unmanned aircraft:
 1. Is flown within a 400-foot radius of a structure; and
 2. Does not fly higher than 400 feet above the structure's immediate uppermost limit.

349.6.6 APPROVED UAVS ONLY

Personnel shall only use a UAV issued and approved by the Department for official police duties. All Department owned UAVs will clearly display the word POLICE. The utilization and deployment of any other UAV while on duty is not authorized.

349.6.7 NO ALTERATION OF UAVS

Personnel shall not remove, dismantle or tamper with any hardware and/or software component of the UAVs.

349.7 PRE-FLIGHT AND FLIGHT PROCEDURES

349.7.1 PRE-FLIGHT PROCEDURE

Pre-flight procedures will be conducted prior to each flight and will be done in accordance with the checklist prepared by the Culver City Police

Culver City Police Department

Culver City PD Policy Manual

Unmanned Aerial Vehicles (UAV) Operations

Department UAV unit and in accordance with the manufacturer's recommendations. Any issues found during the pre-flight will be noted and it will be the decision of the pilot to determine if the issue will alter the safe flight and operation of the UAV.

349.7.2 PRE-FLIGHT PUBLIC NOTIFICATION

Except in instances where officer safety could be jeopardized, or time is of the essence, officers shall utilize the public address (loudspeaker) system, Nixle/Everbridge, and or other social media outlets to make a public announcement to alert people in the area of the UAV operation. To aid in public safety, alerts shall notify the public that a UAV will be used and they should stay inside of their residence or vehicle.

349.7.3 LAUNCH PROCEDURES

Prior to the launch of the UAV, the pilot is responsible for ensuring the checklist has been conducted and the aircraft is safe to operate. The pilot will communicate with an Observer to confirm that the area is visibly clear of any low flying air traffic, hazardous obstacles, or safety hazards prior to lift off.

349.7.4 AIR TRAFFIC CONTROL NOTIFICATIONS

The pilot is responsible for ensuring all notifications to any Air Traffic Control Towers and authorities have been made in accordance with the rules and guidelines set forth by the FAA.

349.8 FLIGHT AND LANDING PROCEDURES

Although the UAV can be flown autonomously, the pilot will monitor the aircraft, base station, and payload systems to ensure the aircraft is flying as designed and maintains the proper altitude. After lift-off, crew members shall perform tasks according to their job assignment, while communicating clearly and effectively to monitor the UAV as it climbs to the desired mission altitude. It will be the responsibility of the pilot to confirm the mission objective has been met or the mission is too unsafe to continue prior to landing the UAV.

The pilot will communicate with the Observer to confirm no obstacles are in the flight path of the UAV and the return "home" location prior to giving the command for the UAV to return home. The Observer will monitor the aircraft as it is landing to ensure a proper landing. If the aircraft is not landing as desired or commanded, the Observer will notify the pilot who will determine if the landing will be aborted.

It will be the responsibility of the pilot to ensure contact is made with any Air Traffic Control Towers to advise completion of the mission in accordance with FAA guidelines.

349.9 PROCEDURES FOLLOWING FLIGHT

349.9.1 DOCUMENTATION

All flights shall be documented by the pilot on a UAV Utilization Form and by a supervisor on a supervisor or Watch Commander's log. The documentation shall, at minimum, include:

- (a) All flight times and locations

Culver City Police Department

Culver City PD Policy Manual

Unmanned Aerial Vehicles (UAV) Operations

- (b) Reason for the flight
- (c) Name of the approving supervisor
- (d) Incident or DR#
- (e) Any additional relevant information to the mission

This information shall be forwarded to the Department's Crime Management Analyst for inclusion in the Culver City Police Department's monthly report and retained for a period of at least two years.

349.9.2 SECURING RECORDINGS

If any incident is recorded with the UAS system, the existence of that recording shall be documented in the case report. Pilots should ensure relevant recordings are preserved in accordance with the Department's retention schedule, which is fully set forth in Section 608.15.

349.9.3 SUPERVISOR DUTIES FOLLOWING MAJOR INCIDENTS

When an incident arises that requires the immediate retrieval of the recorded media (e.g., serious crime scenes, officer-involved shootings, department-involved collisions), a UAV supervisor shall respond to the scene and ensure that the UAV media is properly retrieved. The media may need to be treated as evidence and should be handled in accordance with current evidence procedures for recorded media.

349.10 COLLISIONS

349.10.1 FAA NOTIFICATIONS

If a collision occurs during the operation of a UAV that results in any injury to any person, any loss of consciousness, or if it causes damage to any property (other than the UAV) in excess of \$500 to repair or replace the property, notification shall be made to the Flight Standards District within ten (10) days per FAA guidelines. Current contact information is included below:

- Flight Standards District
 - https://www.faa.gov/about/office_org/field_offices/fsdo/?state=CA
- Los Angeles Flight Standards District Office
 - 15000 Aviation Boulevard, Lawndale CA 90261
 - (310) 725-6000
- Long Beach Flight Standards District Office
 - 5001 Airport Plaza Drive, Long Beach CA 90815
 - (562) 420-1755

349.10.2 INVESTIGATIVE PROCEDURES

While at the scene, the pilot shall notify a supervisor, who shall respond to photograph the collision and any injuries and/or property damage that has occurred. Regardless of the extent of damages, the pilot shall be responsible for completing an Interdepartmental Memorandum to the Chief of

Culver City Police Department

Culver City PD Policy Manual

Unmanned Aerial Vehicles (UAV) Operations

Police, via the Chain of Command, describing the incident and damage. The UAV Manager shall conduct a review of the collision and determine if the collision could have been prevented through maintenance, training, etc., and ensure all necessary paperwork has been submitted and that the appropriate corrective action has been taken.

349.11 UAV PROGRAM MANAGER

The UAV Manager will serve as the UAV program coordinator and will be responsible for managing all aspects of the UAV program. The UAV Manager will ensure that policies and procedures conform to current laws, regulations and best practices, and will have the following additional responsibilities:

- Coordinating the FAA Certificate of Waiver or Authorization (COA) application process and ensuring that the COA is current.
- Ensuring that all authorized operators and required observers have completed all required FAA and department-approved training in the operation, applicable laws, policies and procedures regarding use of the UAV.
- Continually evaluating, developing and maintaining uniform protocol for submission and evaluation of requests to deploy a UAV, including urgent requests made during ongoing and emerging incidents. Deployment of a UAV shall require review by the UAV Manager or the authorized designee, depending on the type of mission.
- Continually evaluating, developing and maintaining protocol for conducting criminal investigations involving a UAV, including documentation of time spent monitoring a subject.
- Implementing and maintaining a system for public notification of UAV deployment.
- Continually evaluating, developing and maintaining an operational protocol governing the deployment and operation of a UAV including, but not limited to, safety oversight, use of visual observers, establishment of lost link procedures and secure communication with air traffic control facilities.
- Continually evaluating, developing and maintaining protocol for fully documenting all missions.
- Continually evaluating, developing and maintaining a UAV inspection, maintenance and record-keeping protocol to ensure continuing airworthiness of a UAV, up to and including its overhaul, repairs, or life limits.
- Continually evaluating, developing and maintaining protocols to ensure that all data intended to be used as evidence are accessed, maintained, stored and retrieved in a manner that ensures its integrity as evidence, including strict adherence to chain of custody requirements. Electronic trails, including encryption, authenticity certificates and date/time stamping, shall be used as appropriate to preserve individual rights and to ensure the authenticity and maintenance of a secure evidentiary chain of custody.
- Continually evaluating, developing and maintaining protocols that ensure retention and purge periods are maintained in accordance with established records retention schedules.

Culver City Police Department

Culver City PD Policy Manual

Unmanned Aerial Vehicles (UAV) Operations

- Facilitating law enforcement access to images and data captured by the UAV.
- Recommending program enhancements, particularly regarding safety and information security.
- Ensuring that established protocols are followed by monitoring and providing periodic reports to the Command Staff.
- Ensuring that recording procedures are followed.

349.12 REVIEW OF UAV RECORDINGS

Recordings may be reviewed in any of the following situations:

- (a) For use by Department personnel when preparing reports or statements.
- (b) By a supervisor investigating a specific act of officer conduct.
- (c) To assess proper functioning of the UAS.
- (d) To assess possible training value.
- (e) Recordings may be viewed and shown for training purposes. If an involved officer objects to showing a recording, the recording will not be shown to other officers. The recording may, however, be viewed by supervisors for training and performance assessment purposes.
- (f) By Department investigators who are participating in an official investigation, such as a personnel complaint, administrative inquiry, or a criminal investigation.
- (g) By any officer captured on or referenced in the video data, who reviews and uses such data to help ensure accuracy.
- (h) Pursuant to a lawful subpoena or by court personnel through proper processes or with permission of the Chief of Police or the Chief's authorized designee.

Subject to the provisions of this policy, the Chief of Police has the discretion to prohibit the review of any recordings by Department employees if it is determined that it is in the best interest of the Police Department or the City of Culver City.

Subject to the provisions of Section 608.12 above, in the event that any employee is to be interviewed pursuant to an investigation related to an incident which results in injury, bodily harm, death or involves the use of force, the employee and/or his/her attorney will be afforded an opportunity to review his/her video of the incident prior to the interview, or after the employee has been interviewed, by the appropriate investigative personnel. If the employee elects to view the video after being interviewed, the employee shall be afforded the opportunity to review the video immediately after providing his/her statement regarding the underlying incident and be given an opportunity to offer a supplemental statement. Prior to the employee offering an initial statement, the following admonishment shall be provided to the employee:

- "In this case, there is video evidence that you have had (or will have) an opportunity to view before (after) giving your initial statement. Video evidence has limitations and may depict the events differently than you recall, and may not capture events normally seen by the human eye. Lighting as seen on the video may be different than what is

Culver City Police Department

Culver City PD Policy Manual

Unmanned Aerial Vehicles (UAV) Operations

seen by the human eye. Videos are a two-dimensional medium and may not capture the depth, distance or positional orientation as well as the human eye. Remember, the video evidence is intended to assist your memory and ensure that your initial statement explains your state of mind at the time of the incident.”

Employees desiring to view any previously uploaded or archived UAV recording that they would not typically have access to should submit a request in writing to a UAV supervisor.

In no event shall any recording be used or shown for the purpose of ridiculing or embarrassing anyone.

During the routine review of recorded media, the Department should consider the totality of the circumstances when evaluating policy concerns, tactical considerations, and officer training opportunities.

349.13 RELEASE OF UAV DATA

All recording media and recorded images are the property of the Culver City Police Department. Dissemination outside of the agency is strictly prohibited, except to the extent required by law.

If the Department receives a request to release UAV data via a subpoena, a Court Order, a civil discovery request, a criminal discovery request, or a California Public Records Act request, Department staff should consult with the City Attorney’s office with any questions regarding the legal issues surrounding the request.

To the extent that release of UAV data is legally required, all media shall be reviewed by the Technical Support Supervisor (or another supervisor if the Technical Support Supervisor is not available) prior to its release. Anything of a personal or confidential nature included in the media should be evaluated by the appropriate personnel, and redacted if deemed appropriate and if permitted by law. All redactions shall be approved by a Bureau Commander. An original copy of the media shall be retained by the Department.

The Chief of Police has the discretion to allow viewing or release of recorded media if he/she determines that it is in the best interest of public safety, the Police Department, and or the City of Culver City, and the viewing or release is in compliance with local, state and federal law.

When appropriate, every effort will be made to notify involved employees prior to release of UAV data.

Notwithstanding any other provision of this Policy 608, any dissemination of recorded media or recorded images shall be consistent with California SB54, the California Values Act, and Culver City Resolution 2017-R025, declaring Culver City to be a sanctuary city.

349.14 MAINTENANCE OF UAV DATA AND UAS

It shall be the responsibility of the UAV Manager to ensure that all media recorded by the UAVs is properly classified for retention when merged into the storage system. The following classifications should be utilized:

Culver City Police Department

Culver City PD Policy Manual

Unmanned Aerial Vehicles (UAV) Operations

- (a) **“Retain”** - All calls for service, enforcement stops, arrest situations, transportation, search warrants, criminal investigations, etc.
- (b) **“Test”** - Only used after testing the working condition of the UAV or for media recorded during training.

Any images and video (media) from the UAV system shall not be copied, exported, or recorded in any way for any purpose other than for circumstances authorized in this policy. Unauthorized use, duplication, and/or distribution of UAV files is prohibited. Personnel shall not make copies of any UAV file for their personal use and are prohibited from using a recording device such as a cellphone camera or secondary video camera to record UAV files.

To prevent damage to or altering of the original recorded media, it shall not be copied, viewed or otherwise inserted into any device not approved by the Department Systems Support Manager. When reasonably possible, a copy of the original media shall be used for viewing (unless otherwise directed by the courts) to preserve the original media.

UAV systems should be assembled and equipped based on the manufacturer’s recommendations. Officers shall not erase, alter, reuse, modify or tamper with UAV recordings. To prevent damage, original recordings shall not be viewed on equipment other than the equipment issued or authorized by the Systems Support Manager. The UAV will be purchased and maintained by the Culver City Police Department. Only the UAV systems authorized by the Culver City Police Department should be deployed. The UAV shall be maintained regularly per the user manual and manufacturer’s recommendations. Only properly trained personnel shall complete any repairs or perform maintenance on the UAV.

Any UAV supervisor that is informed or otherwise become aware of a malfunctioning UAV shall ensure that authorized personnel make repairs in a timely manner.

349.15 RECORDING MEDIA STORAGE, RETENTION AND INTEGRITY

349.15.1 RETENTION TIME

If a recording is identified as evidence, the retention will follow the Evidence/Property Files retention schedule. Recordings which become part of a citizen complaint or administrative/internal investigation will follow the retention time identified for the complaint/investigation. Notwithstanding the foregoing, all recordings shall be retained for a minimum of two (2) years.

349.15.2 INADVERTENT OR ACCIDENTAL RECORDINGS

Inadvertent/accidental recordings of personal events and conversations may be purged as soon as practicable upon the approval of a Bureau Commander.

349.15.3 LABELLING AND STORAGE

Once submitted for evidence storage, all recording media will be labeled and stored in a designated secure area in accordance with proper evidence procedures.

Culver City Police Department

Culver City PD Policy Manual

Unmanned Aerial Vehicles (UAV) Operations

349.15.4 MODIFYING RETENTION PERIOD

Anyone with the authorization to do so may increase the retention time for recordings when it is believed that retaining said recordings for a longer period of time would be in the best interest of the Department or the City.

349.16 DATA COLLECTION

Monthly statistics shall be submitted by the UAV Sergeant to the UAV Manager for review each month. These reports should include:

- (a) Number of flights
- (b) Personnel involved
- (c) Total time the UAVs were used
- (d) Any maintenance that was completed on the UAVs
- (e) Any additional relevant information regarding missions there were performed

Control Devices- Chemical Agents

350.1 PURPOSE AND SCOPE

This policy provides guidelines for the use and maintenance of control devices (chemical agents) that are described in this policy.

350.2 POLICY

In order to control subjects who are violent or who demonstrate the intent to be violent, the Culver City Police Department authorizes officers to use chemical weapons in accordance with the guidelines in this policy and the Use of Force Policy.

350.3 USER RESPONSIBILITIES

All normal maintenance, charging, or cleaning shall remain the responsibility of personnel using the various devices. Any damaged, inoperative, outdated, or expended control devices, munitions, or chemical agents along with documentation explaining the cause of the damage, shall be returned to the Rangemaster for disposition. Damage to City property forms shall also be prepared and forwarded through the chain of command, when appropriate, explaining the cause of damage.

350.4 RANGE MASTER RESPONSIBILITIES

The Rangemaster (and/or ERT Armorer) shall control the inventory and issuance of all chemical agents and shall ensure that all damaged, inoperative, outdated, or expended control devices or munitions are properly disposed of, repaired, or replaced.

Every chemical agent system will be periodically inspected by the Rangemaster or the designated instructor for a particular control device. The inspection shall be documented and forwarded up the Chain of Command.

350.5 TEAR GAS

Chemical agent munitions, which are commonly referred to as "tear gas," are used by the Culver City Police Department as a less-lethal tool to control and/or gain compliance during a violent encounter with a felony suspect. All chemical agents will be used only in compliance with Penal Code section 13652 and the department's Use of Force policy.

The Culver City Police Department uses chemical agents which are used by law enforcement across the United States: CS (2-Chlorobenzylidenemalononitrile) and OC (Oleoresin Capsicum).

CS is an irritating agent and lachrymator that irritates the eyes and causes tears to flow. CS has been medically tested in the U.K. and U.S., specifically by the U.S. Army. There are no known allergic reactions to CS.

350.6 GUIDELINE FOR USE

To act as, and shall be limited to, a de-escalation and less-lethal option during the following situations:

- (a) Self-destructive, dangerous, violent, and/or physically combative individuals.

Culver City Police Department

Culver City PD Policy Manual

Control Devices- Chemical Agents

- (b) Violent riotous crowd control incidents when such weapons are necessary to defend against a threat to life or serious bodily injury to any individual, including a peace officer, or to bring a violent, dangerous, and unlawful situation safely and effectively under control. Tear gas shall not be used against individuals or groups who merely fail to disperse or do not reasonably appear to present a risk to the safety of officers or the public.
- (c) Circumstances where the Emergency Response Team members can obtain a tactical advantage during the following critical incidents: Barricaded violent felony suspect, vehicle barricade of a felony suspect, active shooter, or a hostage rescue operation.
- (d) Potentially vicious animals.
- (e) During department-approved training exercises

350.7 AUTHORIZED USE

- (a) Chemical Agents shall only be used by officers who have received POST certification in the use of chemical agents and in a manner consistent with Department policy.
- (b) The use of chemical agents for the dispersal of riotous crowds must first be authorized by the Chief of Police.
- (c) All other approved uses of tear gas must first be authorized by a Bureau Captain.
- (d) During department-approved training exercises.
- (e) In compliance with Department Policy 300 (Use of Force), as well as federal, state, and local laws and ordinances.

When practicable, fire personnel should be alerted or summoned to the scene prior to the deployment of tear gas to control any fires and to assist in providing medical aid or gas evacuation if needed.

350.8 OLEORESIN CAPSICUM SYSTEMS (OC)- SPRAY AND FOGGERS

OC was de-regulated in California in 1996, is endorsed by the FBI, and is available to civilians to legally possess (2.5oz or less). OC is an inflammatory agent which causes involuntary closure of the eyes for a duration of 2 to 5 minutes and respiratory inflammation, which subsides in approximately 2 minutes.

As with other control devices, oleoresin capsicum (OC) spray may be used to bring under control an individual, or groups of individuals, who are engaging in violent, assaultive, or actively resistive behavior, as defined in Use of Force Policy 300. OC spray should not, however, be used against individuals or groups who merely fail to disperse or do not reasonably appear to present a risk to the safety of officers or the public.

Uniformed personnel carrying OC spray shall carry the device in its holster on the equipment belt. Plain clothes and non-field personnel may carry OC spray as authorized, in accordance with the needs of their assignment or at the direction of their supervisor

Culver City Police Department

Culver City PD Policy Manual

Control Devices- Chemical Agents

350.9 TREATMENT FOR OC SPRAY EXPOSURE

Persons who have been sprayed with or otherwise affected by the use of OC should be promptly provided with clean water to cleanse the affected areas. Officers and supervisors on-scene should consider requesting emergency medical response after any OC exposure but especially when clean water is unavailable. Those persons who complain of further severe effects shall be examined by appropriate medical personnel.

350.10 PEPPERBALL LAUNCHER

A system that uses high-pressure air to deliver Pelargonic Acid Vanillylamide (PAVA) powder projectiles or inert rounds (similar to a paintball delivery system). This system can launch projectiles at a subject up to 60'. In addition, the system is capable of area saturation up to 150'. Non-lethal option offers law enforcement officers to deliver chemical agents and kinetic energy impacts to subjects in a potentially violent encounter. De-Escalation tools are used to avoid further injuries or lethal options on a subject.

350.11 GUIDELINE FOR USE

To act as, and shall be limited to, a de-escalation and less lethal option during the following situations:

- (a) Self-destructive, violent, dangerous and/or combative individuals.
- (b) Violent Riotous crowd control incidents when such weapons are deemed necessary to defend against a threat to life or serious bodily injury to any individual, including a peace officer, or to bring an objectively dangerous and unlawful situation safely and effectively under control.
- (c) Potentially vicious animals.
- (d) During department-approved training exercises

Before discharging projectiles, the officer should consider such factors as:

- (a) Distance and angle to target
- (b) Type of munitions employed
- (c) Type and thickness of subject's clothing
- (d) The subject's proximity to others
- (e) The location of the subject
- (f) Whether the subject's actions dictate the need for an immediate response and the use of control devices appears appropriate

A verbal warning of the device's intended use should precede its application unless it would otherwise endanger the safety of officers or when it is not practicable due to the circumstances. The purpose of the warning is to give the individual a reasonable opportunity to voluntarily comply and to warn other officers and individuals that the device is being deployed.

Culver City Police Department

Culver City PD Policy Manual

Control Devices- Chemical Agents

Officers should keep in mind the manufacturer's recommendations and their training regarding effective distances and target areas. Each situation must be evaluated on the totality of circumstances at the time of deployment.

The need to immediately incapacitate the subject must be weighed against the risk of causing serious injury or death. The head and neck should not be intentionally targeted, except when the officer reasonably believes the suspect poses an imminent threat of serious bodily injury or death to the officer or others.

350.12 AUTHORIZED USE

- (a) Only those officers who have been trained in the use of Projectile Launchers are authorized to use the Projectile Launchers, in a manner consistent with Department policy.
- (b) Use for dispersal of riotous crowds must first be authorized by the Chief of Police
- (c) All other use of Projectile Launchers must first be authorized by the on-duty Watch Commander or the on-scene Field Supervisor.
- (d) In compliance with Department Policy 300 (Use of Force), as well as federal, state, and local laws and ordinances.

350.13 CHEMICAL AGENTS REPORTING GUIDELINES

Any chemical agent application listed in this policy shall be documented in the related incident report and reported to a supervisor pursuant to the Use of Force Policy (300), and fully reviewed in compliance with policy section 301 (Use of force review). In addition, the deployment of any chemical agents listed in section 704 (Military Equipment) shall also be documented in the yearly Military Use Report.

350.14 TRAINING FOR CONTROL DEVICES- CHEMICAL AGENTS

The Personnel and Training Lieutenant shall ensure that all personnel who are authorized to carry a control device have been properly trained and certified to carry the specific control device and are retrained or recertified as necessary.

- (a) Proficiency training shall be monitored and documented by a certified, control-device weapons or tactics instructor.
- (b) All training and proficiency for control devices will be documented in the officer's training file.
- (c) Officers who fail to demonstrate proficiency with the control device or knowledge of this agency's Use of Force Policy will be provided remedial training. If an officer cannot demonstrate proficiency with a control device or knowledge of this agency's Use of Force Policy after remedial training, the officer will be restricted from carrying the control device and may be subject to discipline.

350.15 POST- APPLICATION NOTICE

Whenever tear gas or OC has been introduced into a residence, builder interior, vehicle, or other enclosed area, officers should notify the owners or available occupants with notice of the possible

Culver City Police Department

Culver City PD Policy Manual

Control Devices- Chemical Agents

presence of residue that could result in irritation or injury if the area is not properly cleaned. Such notice should include an advisement that cleanup will be at the owner's expense. Information regarding the method of notice and the individuals notified should be included in related reports.

Chapter 4 - Patrol Operations

Patrol Function

400.1 PURPOSE AND SCOPE

The purpose of this policy is to define the patrol function and address intraorganizational cooperation and information sharing.

400.2 POLICY

The Culver City Police Department provides patrol services 24 hours a day, seven days a week and will prioritize responses to requests for emergency services using available resources to enhance the safety of the public and department members.

400.3 FUNCTION

Patrol will generally be conducted by uniformed officers in clearly marked law enforcement vehicles in assigned jurisdictional areas of Culver City. The function of patrol is to respond to calls for assistance and reports of criminal activity, act as a deterrent to crime, enforce state and local laws, identify community needs, provide support and assistance to the community and respond to emergencies.

Patrol services include, but are not limited to:

- (a) Responding to emergency calls for service.
- (b) Apprehending criminal offenders.
- (c) Providing mutual aid and assistance to other agencies for emergency and law enforcement-related activities.
- (d) Preventing criminal acts, traffic violations and collisions, maintaining public order and discovering hazardous situations or conditions.
- (e) Responding to reports of criminal and non-criminal acts.
- (f) Responding to routine calls for service, such as public assistance or public safety.
- (g) Carrying out crime prevention activities such as residential inspections, business inspections and community presentations.
- (h) Carrying out community oriented policing and problem-solving activities including the application of resources to improve or resolve specific problems or situations and contacting or assisting members of the public in a positive way.
- (i) Directing and controlling traffic.

400.4 ASSIGNED PATROL AREAS

At the beginning of each shift, each officer shall be assigned to a specific patrol district or area of responsibility for that shift. In some cases this area may be city-wide but in every case shall consist of an area within the boundaries of the City of Culver City.

Culver City Police Department

Culver City PD Policy Manual

Patrol Function

400.4.1 DEPARTURE FROM ASSIGNED PATROL AREAS

Unless authorized to leave, uniformed officers are required to remain within their assigned patrol areas during their shift. This section shall not prevent officers from approved departures from their areas for Code 7, to handle radio calls, or in response to emergency reports received in the field, when appropriate. In all cases where it is necessary for a uniformed officer to depart from his assigned patrol area he shall, as soon as practical, notify Communications of said departure and the reason for the action. Communications shall then notify the on-duty supervisor as soon as practical. The Department recognizes that some of the corporate boundaries of Culver City intermingle with those of the City and County of Los Angeles. Nothing in these sections prevents uniformed officers, in the course of their duties, from passing through these jurisdictional boundaries if they are contained within their district or if they are proceeding to a radio call or other assignment and the most direct route of travel takes them over these boundaries.

400.5 INFORMATION SHARING

To the extent feasible, all information relevant to the mission of the Department should be shared among all bureaus and specialized units on a timely basis. Members should be provided with opportunities on a regular basis to share information during the daily roll call briefings and to attend roll call briefings of other bureaus or specialized units.

Additionally, information should be shared with outside agencies and the public in conformance with department policies and applicable laws. Members are encouraged to share information with other units and bureaus.

400.5.1 CRIME REPORTS

A crime report may be completed by any patrol officer or Community Service Officer who receives criminal information. The report will be processed and forwarded to the appropriate bureau for retention or follow-up investigation.

400.5.2 PATROL BRIEFINGS

Patrol supervisors, detective sergeants, and special unit sergeants are encouraged to share information as much as possible. All supervisors and/or officers will be provided an opportunity to share information at the daily patrol briefing(s) as time permits.

400.6 CROWDS, EVENTS AND GATHERINGS

Officers may encounter gatherings of people, including but not limited to, civil demonstrations, civic, social and business events, public displays, parades and sporting events. Officers should monitor such events as time permits in an effort to keep the peace and protect the safety and rights of those present. A patrol supervisor should be notified when it becomes reasonably foreseeable that such an event may require increased monitoring, contact or intervention.

Officers responding to an event or gathering that warrants law enforcement involvement should carefully balance the speech and association rights of those present with applicable public safety concerns before taking enforcement action.

Culver City Police Department

Culver City PD Policy Manual

Patrol Function

Generally, officers should consider seeking compliance through advisements and warnings for minor violations and should reserve greater enforcement options for more serious violations or when voluntary compliance with the law is not achieved.

Officers are encouraged to contact organizers or responsible persons to seek voluntary compliance that may address relevant public safety/order concerns.

Officers should consider enforcement of applicable state and local laws, such as Penal Code 602.1 (obstructing or intimidating business operators), when the activity blocks the entrance or egress of a facility or location and when voluntary compliance with the law is not achieved.

400.7 TERRORISM

It is the goal of the Culver City Police Department to make every reasonable effort to accurately and appropriately gather and report any information that may relate to either foreign or domestic terrorism. Officers should advise a supervisor as soon as practicable of any activity believed to be terrorism related and should document such incidents with a written report or Field Interview card (FI). The supervisor should ensure that all terrorism related reports and FIs are forwarded to the Investigations Bureau Supervisor or a Terrorism Liaison Officer (TLO) in a timely fashion.

400.8 TRAFFIC STOP POLICY

Purpose

While the exercise of an officer's discretion in initiating a traffic stop is authorized under the law, that discretion should reflect the necessary balance of the role of law enforcement in the prevention of crime, along with promoting traffic safety with maintaining the community's trust that the officer's actions are fair and without bias. To maintain public trust, the Department's use of vehicle code laws to conduct traffic stops as a crime reduction strategy must be measured, in furtherance of achieving the necessary balance between the perception of fairness and identifying those engaged in criminal conduct.

The Department has created a policy where traffic enforcement will be utilized in a more effective and efficient manner, with a primary focus on enforcing hazardous moving violations (ie: speeding, red lights, illegal turns, use of cell phone while driving etc.) rather than minor equipment violations (ie: expired registration, inoperable license plate light, a single cracked taillight etc.) to promote traffic safety in an effort to reduce traffic injuries and fatalities.

Traffic Stops

One of the primary functions of patrol officers is to enforce traffic safety laws. Traffic stops should be made for the sole purpose of enforcing the Vehicle Code or other codes that are intended to protect public safety. Generally, officers should only make traffic stops for hazardous moving violations (ie: speeding, red lights, illegal turns, use of cell phone while driving etc.) in the spirit of promoting traffic safety.

However, officers may make traffic stops for equipment violations when the officer believes that the violation creates a traffic safety issue (ie: inoperable brakelights, inoperable headlights, inoperable

Culver City Police Department

Culver City PD Policy Manual

Patrol Function

turn signal, bald tires, cracked windshield etc.). Additionally, traffic stops for equipment violations may be made if the officer is acting on articulable information, in addition to the traffic violation, that would lead the officer to believe that a crime is occurring, has occurred, or is about to occur by the driver and/or the occupants of the vehicle. An officer's training, experience and expertise may be used in articulating any additional information used to initiate the traffic stop.

Duration and Scope

Officers' actions during all traffic stops should be limited to the original legal basis for the stop, absent articulable reasonable suspicion or probable cause of criminal activity that would justify extending the duration or expanding the scope of the detention. Officers should not extend the duration or expand the scope of the detention beyond the original legal basis for the stop without additional reasonable suspicion and/or probable cause.

Patrol Equipment

401.1 PURPOSE AND SCOPE

In order to perform their duties at the highest level, police officers need certain equipment to be readily available to them. This policy provides a description of both required and optional equipment for officers working in the field.

401.1.1 REQUIRED EQUIPMENT FOR UNIFORMED OFFICERS WORKING THE FIELD

In addition to the basic uniform, sworn personnel engaged in uniform field duty shall carry the following equipment:

- (a) **Ballistic vest** - department issued
- (b) **Handcuffs and Key** - Handcuffs and key shall be carried at all times.
- (c) **TASER** - The Departmentally approved Taser shall be carried by Officers and Sergeants while engaged in field operations. See Policy 309 for further guidelines.
- (d) **Helmet** - Department issued ballistic helmet and face shield.
- (e) **Flashlight** - A flashlight shall be carried during the hours of darkness.
- (f) **Report Books** - Report forms normally used in field operations shall be carried by officers assigned to field duty.
- (g) **Notebook** - A pocket sized notebook should be carried by all officers assigned to field duty.
- (h) **Traffic Citation Books** - Both moving citation and parking citation books shall be carried.
- (i) **Writing Equipment** - Ball point pen with black or blue ink and mechanical or regular pencils shall be carried in the pen pocket. They shall not be clipped over the pocket nor be exposed to view.

Officers working plain clothes details are only required to carry the following items:

- Department badge and identification card.
- Official duty weapon, unless another type of weapon is authorized by the Chief of Police.
- Pocket notebook.
- Pen with blue or black ink.
- Minimum of five rounds of extra ammunition.

Exception: Officers detailed to undercover duty wherein it is necessary to conceal their identity, may be excused by their Bureau Commanders from the provision of all or part of this section.

401.1.2 OPTIONAL EQUIPMENT FOR UNIFORMED OFFICERS WORKING THE FIELD

In addition to the equipment in the foregoing sections, the individual officer may carry the following items:

Culver City Police Department

Culver City PD Policy Manual

Patrol Equipment

- (a) Oleoresin Capsicum Spray (OC) - Department issued pepper spray may be carried in a black basket weave or nylon carrying case.
- (b) Disposable plastic handcuffs/flex-cuffs.
- (c) Police whistle (Traffic personnel only) at the Operations Bureau Commander's discretion.
- (d) A miniature flashlight may be worn on the uniform belt consistent with other accessories in a holder.
- (e) A leg restraint device (if properly trained).
- (f) A weapon-mounted light may be carried for on-duty use with Department approved weapons. The H&K UTL and Sure Fire Tactical lights are two options available. No other types of sight devices i.e. laser sights, "red dot sights" or telescopic sights are authorized.
 - 1. Should officers choose to use this equipment it will be purchased at their own expense. This includes the pouch and duty holster. The duty holster will not be a tactical type of holster that rides at the officer's thigh (Officers working in modified uniform or assigned to the Canine Unit may wear a holster on the thigh). Officers may carry the tactical light on their duty belt or attached to their duty weapon. Any officer desiring to carry these lights shall demonstrate proficiency before his/her supervisor or the Rangemaster and shall forward an IDC, through the chain of command, requesting authorization from the Chief of Police.
- (g) A reflex sight may be carried on Department approved handguns, once the officer has demonstrated proficiency and the sight has been inspected by the Rangemaster. The requesting officer shall forward an IDC, through the chain of command, requesting authorization from the Chief of Police or his designee.
 - 1. Optic/suppressor height back-up iron sights shall be mounted on the host handgun in case of circuitry or battery malfunction.
 - 2. Officers who wish to carry a handgun with a reflex sight shall purchase it with their personal funds, provide his / her own holster, mounting, maintenance and batteries. The holster shall be of a minimum Level II retention holster for patrol and regular uniformed duties. When assigned to a modified uniform detail, the holster shall cover the trigger guard.

Bias-Based Policing

402.1 PURPOSE AND SCOPE

This policy provides guidance to department members that affirms the Culver City Police Department's commitment to policing that is fair and objective.

Nothing in this policy prohibits the use of specified characteristics in law enforcement activities designed to strengthen the department's relationship with its diverse communities (e.g., cultural and ethnicity awareness training, youth programs, community group outreach, partnerships).

402.1.1 DEFINITIONS

Definitions related to this policy include:

Bias-based policing or improper profiling - An inappropriate reliance on actual or perceived characteristics such as race, ethnicity, national origin (including limited English proficiency), religion, sex, sexual orientation, gender identity or expression, economic status, age, cultural group, disability, or affiliation with any non-criminal group (protected characteristics) as the basis for providing differing law enforcement service or enforcement (Penal Code § 13519.4). This includes explicit and implicit biases (i.e., conscious and unconscious beliefs or attitudes towards certain groups).

402.2 POLICY

The Culver City Police Department is committed to providing law enforcement services to the community with due regard for the racial, cultural or other differences of those served. It is the policy of this department to provide law enforcement services and to enforce the law equally, fairly, objectively and without discrimination toward any individual or group.

402.3 BIAS-BASED POLICING PROHIBITED

Bias-based policing is strictly prohibited.

However, nothing in this policy is intended to prohibit an officer from considering protected characteristics in combination with credible, timely and distinct information connecting a person or people of a specific characteristic to a specific unlawful incident, or to specific unlawful incidents, specific criminal patterns or specific schemes.

402.3.1 CALIFORNIA RELIGIOUS FREEDOM ACT

Members shall not collect information from a person based on religious belief, practice, affiliation, national origin or ethnicity unless permitted under state or federal law (Government Code § 8310.3).

Members shall not assist federal government authorities (Government Code § 8310.3):

- (a) In compiling personal information about a person's religious belief, practice, affiliation, national origin or ethnicity.

Culver City Police Department

Culver City PD Policy Manual

Bias-Based Policing

- (b) By investigating, enforcing or assisting with the investigation or enforcement of any requirement that a person register with the federal government based on religious belief, practice, or affiliation, or national origin or ethnicity.

402.4 MEMBER RESPONSIBILITIES

Every member of this department shall perform his/her duties in a fair and objective manner and is responsible for promptly reporting any suspected or known instances of bias-based policing to a supervisor. Members should, when reasonable to do so, intervene to prevent any biased-based actions by another member.

402.4.1 REPORTING OF STOPS

Unless an exception applies under 11 CCR 999.227, an officer conducting a stop of a person shall collect the data elements required by Government Code § 12525.5 and 11 CCR 999.226 for every person stopped and prepare a stop data report. When multiple officers conduct a stop, the officer with the highest level of engagement with the person shall collect the data elements and prepare the report (11 CCR 999.227).

If multiple agencies are involved in a stop and the Culver City Police Department is the primary agency, the Culver City Police Department officer shall collect the data elements and prepare the stop data report (11 CCR 999.227).

The stop data report should be completed by the end of the officer's shift or as soon as practicable (11 CCR 999.227).

402.4.2 DISCLOSURE AND DOCUMENTATION OF TRAFFIC OR PEDESTRIAN STOP

An officer conducting a traffic or pedestrian stop shall state the reason for the stop prior to questioning the individual related to a criminal investigation or traffic violation unless the officer reasonably believes that withholding the reason for the stop is necessary to protect life or property from imminent threat, including but not limited to cases of terrorism or kidnapping (Vehicle Code § 2806.5).

Officers shall document the reason for the stop on any citation or report (Vehicle Code § 2806.5).

402.5 SUPERVISOR RESPONSIBILITIES

Supervisors should monitor those individuals under their command for compliance with this policy and shall handle any alleged or observed violations in accordance with the Personnel Complaints Policy.

- (a) Supervisors should discuss any issues with the involved officer and his/her supervisor in a timely manner.
 - 1. Supervisors should document these discussions, in the prescribed manner.
- (b) Supervisors should periodically review MAV recordings, portable audio/video recordings, Mobile Digital Computer (MDC) data and any other available resource used to document contact between officers and the public to ensure compliance with the policy.

Culver City Police Department

Culver City PD Policy Manual

Bias-Based Policing

1. Supervisors should document these periodic reviews.
 2. Recordings or data that capture a potential instance of bias-based policing should be appropriately retained for administrative investigation purposes.
- (c) Supervisors shall initiate investigations of any actual or alleged violations of this policy.
- (d) Supervisors should take prompt and reasonable steps to address any retaliatory action taken against any member of this department who discloses information concerning bias-based policing.

402.6 TRAINING

Training on fair and objective policing and review of this policy shall be conducted annually and include:

- (a) Explicit and implicit biases.
- (b) Avoiding improper profiling.

402.6.1 ADDITIONAL STATE REQUIREMENTS

Training should be conducted as directed by the Personnel and Training.

- (a) All sworn members of this department will be scheduled to attend Peace Officer Standards and Training (POST)-approved training on the subject of bias-based policing.
- (b) Pending participation in such POST-approved training and at all times, all members of this department are encouraged to familiarize themselves with and consider racial and cultural differences among members of this community.
- (c) Each sworn member of this department who received initial bias-based policing training will thereafter be required to complete an approved POST refresher course every five years, or sooner if deemed necessary, in order to keep current with changing racial, identity, and cultural trends (Penal Code § 13519.4(i)).

402.7 REPORTING TO CALIFORNIA DEPARTMENT OF JUSTICE

The Professional Standards Unit Manager shall ensure that all data required by the California Department of Justice (DOJ) regarding complaints of racial bias against officers is collected and provided to the Records Supervisor for required reporting to the DOJ (Penal Code § 13012; Penal Code § 13020). See the Records Section Policy.

Supervisors should ensure that stop data reports are provided to the Records Supervisor for required monthly reporting to the DOJ (Government Code § 12525.5) (See Records Bureau Policy).

Briefing Training

403.1 PURPOSE AND SCOPE

Roll Call Briefing training is generally conducted at the beginning of the officer's assigned shift. Roll Call Briefing provides an opportunity for important exchange between employees and supervisors. A supervisor generally will conduct Roll Call Briefing; however officers may conduct Roll Call Briefing for training purposes with supervisor approval.

Roll Call Briefing should accomplish, at a minimum, the following basic tasks:

- (a) Briefing officers with information regarding daily patrol activity, with particular attention given to unusual situations and changes in the status of wanted persons, stolen vehicles, and major investigations
- (b) Notifying officers of changes in schedules and assignments
- (c) Notifying officers of new General Orders or changes in General Orders
- (d) Reviewing recent incidents for training purposes
- (e) Providing training on a variety of subjects

403.2 PREPARATION OF MATERIALS

The supervisor conducting Roll Call Briefing is responsible for preparation of the materials necessary for a constructive briefing. Supervisors may delegate this responsibility to a subordinate officer in his or her absence or for training purposes.

403.3 RETENTION OF ROLL CALL BRIEFING TRAINING RECORDS

Roll Call Briefing training materials and a curriculum or summary shall be forwarded to the Personnel and Training Lieutenant for inclusion in training records, as appropriate.

Front Desk Officer/Community Service Officer

404.1 PURPOSE AND SCOPE

This policy sets guidelines for the function and responsibilities of police officers and community service officers working the front desk.

404.2 RESPONSIBILITIES

The front desk officer and or community service officer shall assist and direct all persons entering the police facility through the front entrance. The front desk officer will be responsible for ascertaining the particular needs of an individual and ensuring that the person is provided with the appropriate assistance.

The front desk officer and or community service officer shall remain cognizant of visitor needs and address those needs in a timely and professional manner. The employee assigned to the front desk is responsible for directing visitors to the appropriate sources of service and information. In addition to providing referral services within the department (i.e., investigative services, fingerprint services, reports/records information), the front desk officer and or community service officer should direct visitors to the resources of other agencies (i.e., city department, other governmental agencies, social services agencies, etc.) when suitable. If conditions are such that the front desk officer and or community service officer cannot provide the appropriate level of service, the Watch Commander should be advised and appropriate action taken.

404.2.1 TELEPHONE COMMUNICATIONS

The front desk officer and or community service officer shall answer all incoming calls to the front desk.

All employees shall limit self-initiated telephone calls to those that are essential to the employees assigned duties.

404.2.2 POLICE REPORTS

The front desk officer and or community service officer will take crime or incident reports as appropriate.

404.2.3 LIVE SCAN

Live Scan and fingerprinting services are typically available to the public Monday through Friday between the hours of 0700 hours and 1500 hours; excluding holidays. Live Scan will generally be performed by a community service officer.

404.2.4 POLICE FACILITY VISITORS

The front desk officer and or community service officer shall determine the needs of each visitor. If the visitor has legitimate business with the department, the visitor shall be directed to the appropriate individual or bureau. All visitors to the department are required to check-in at the front desk. Visitors from other law enforcement agencies must display their picture identification card or badge in plain sight.

Culver City Police Department

Culver City PD Policy Manual

Front Desk Officer/Community Service Officer

The front desk officer or community service officer shall issue a visitors pass, obtain a valid form of identification in return, and complete the visitor's sign-in log permitting the visitor to access the facility. The visitor will only be admitted to the facility when escorted by a department employee. Exceptions may be authorized by the Watch Commander or a supervisor.

When it is apparent that a visitor does not intend to conduct legitimate business within the police facility, or the visitor poses a potential threat to the police operations and or personnel, the front desk officer or community service officer will immediately notify the communications center and request an officer or supervisor.

The front desk officer and or community service officer shall immediately notify the communications center when there is a disturbance or a disruption of city business at the front desk.

404.2.5 BUILDING SECURITY

The Watch Commander is ultimately responsible for ensuring that adequate security is maintained at the front entrance of the police facility.

The access door adjacent to the front counter shall remain secured, and all visitors shall not be permitted beyond the front desk lobby until such time that the front desk officer or the community service officer has determined a legitimate need for access. Only those persons requesting or requiring service provided by this agency shall be permitted to remain within the police facility.

There should be at least one armed sworn employee on the police facility property at all times.

404.2.6 DELIVERIES AT THE FRONT DESK

The front desk officer or community service officer is responsible for receiving deliveries at the front desk both during and after business hours.

All mail, newspapers, gratuities or gifts received at the front desk shall be forwarded without unnecessary delay to the appropriate recipient.

Crime and Disaster Scene Integrity

405.1 PURPOSE AND SCOPE

The purpose of this policy is to provide guidance in handling a major crime or disaster.

405.2 POLICY

It is the policy of the Culver City Police Department to secure crime or disaster scenes so that evidence is preserved, and to identify and mitigate the dangers associated with a major crime or disaster scene for the safety of the community and those required to enter or work near the scene.

405.3 SCENE RESPONSIBILITY

The first officer at the scene of a crime or major incident is generally responsible for the immediate safety of the public and preservation of the scene. Officers shall also consider officer safety and the safety of those persons entering or exiting the area, including those rendering medical aid to any injured parties. Once an officer has assumed or been assigned to maintain the integrity and security of the crime or disaster scene, the officer shall maintain the crime or disaster scene until he/she is properly relieved by a supervisor or other designated person.

405.4 FIRST RESPONDER CONSIDERATIONS

The following list generally describes the first responder's function at a crime or disaster scene. This list is not intended to be all-inclusive, is not necessarily in order and may be altered according to the demands of each situation:

- (a) Broadcast emergency information, including requests for additional assistance and resources.
- (b) Provide for the general safety of those within the immediate area by mitigating, reducing or eliminating threats or dangers.
- (c) Locate or identify suspects and determine whether dangerous suspects are still within the area.
- (d) Provide first aid to injured parties if it can be done safely.
- (e) Evacuate the location safely as required or appropriate.
- (f) Secure the inner perimeter.
- (g) Protect items of apparent evidentiary value.
- (h) Secure an outer perimeter.
- (i) Identify potential witnesses.
- (j) Start a chronological log noting critical times and personnel allowed access.

405.5 SEARCHES

Officers arriving at crime or disaster scenes are often faced with the immediate need to search for and render aid to victims, and to determine if suspects are present and continue to pose a threat. Once officers are satisfied that no additional suspects are present and/or there are no injured

Culver City Police Department

Culver City PD Policy Manual

Crime and Disaster Scene Integrity

persons to be treated, those exigent circumstances will likely no longer exist. Officers should thereafter secure the scene and conduct no further search until additional or alternate authority for the search is obtained, such as consent or a search warrant.

405.5.1 CONSENT

When possible, officers should seek written consent to search from authorized individuals. However, in the case of serious crimes or major investigations, it may be prudent to also obtain a search warrant. Consent as an additional authorization may be sought, even in cases where a search warrant has been granted.

405.6 EXECUTION OF HEALTH ORDERS

Any sworn member of this department is authorized to enforce all orders of the local health officer that have been issued for the purpose of preventing the spread of any contagious, infectious or communicable disease (Health and Safety Code § 120155).

Mutual Aid & Tactical Mobilization

406.1 PURPOSE AND SCOPE

Mutual Aid and Tactical Mobilization plans are established to restore and maintain order during emergencies, including civil unrest and to provide assistance to local agencies during other unusual and or major events.

406.1.1 STRUCTURE AND GUIDELINES

As a component of the Standardized Emergency Management System [SEMS], the System is based on four organizational levels: cities, counties, regions and the state. (A county is an operational area along with its political sub-divisions) The state is divided into seven Law Enforcement Mutual Aid Regions. Each sheriff serves as the Operational Area Coordinator. Within each region, one sheriff is elected to serve as the Regional Mutual Aid Coordinator.

When the Chief of Police determines that an emergency situation may become or is already beyond the control of the department's resources, it is his responsibility to request mutual aid from the Operational Area Coordinator (Beverly Hills Police Department).

The basic concept provides that within the operational area, adjacent or neighboring law enforcement agencies will assist each other. Should the event require assistance from outside the county, the region will provide assistance to the impacted county. If the combined resources of the region are insufficient to cope with the incident, the Regional Coordinator will contact the State Law Enforcement Mutual Aid Coordinator at the Office of Emergency Services. Nothing in this section is intended to restrict watch commanders from providing immediate mutual assistance to neighboring cities in critical or life threatening situations. When such requests are made, the watch commander will provide resources to the requesting agency so as not to adversely impact the department's delivery of police service. Requests for assistance will be evaluated on a case by case basis weighing all the attendant factors. Generally it is acceptable to send personnel that do not exceed 50% of the on duty field force, accompanied by a supervisor.

406.1.2 UNUSUAL INCIDENTS NOTIFICATION

Officers investigating an incident that is or may be, in the officer's opinion, of unusual concern to the Department, or which requires major police action, shall notify or cause to be notified the Watch Commander. If in the opinion of the Watch Commander, the incident is of major concern to the Department, he/she shall notify the Patrol Bureau Commander. Such incidents shall include:

- (a) Natural occurrences such as earthquakes, serious floods and landslides.
- (b) Fires, explosions, train wrecks, and traffic collisions of major proportions.
- (c) Major disturbances or mass arrests.
- (d) Any unusual, vicious or significant crimes.
- (e) Death or serious injury of a Department employee on or off-duty.
- (f) Massive searches in pursuit of dangerous suspects.

Culver City Police Department

Culver City PD Policy Manual

Mutual Aid & Tactical Mobilization

406.1.3 TACTICAL MOBILIZATION PLAN

In the event of an unusual occurrence or extreme emergency of such magnitude that the entire resources of the Department are required, a tactical mobilization may be called. The uniform of the day for the tactical mobilization shall be determined by the Chief of Police or his/her designee.

According to the following procedure, the Chief of Police or his designee shall authorize such mobilization for the necessary deployment of the Department.

- (a) The Watch Commander shall cause the notification of command officers in the following order:
 - Chief of Police
 - Patrol Bureau Commander
 - Administration Bureau Commander
 - Special Operations Bureau Bureau Commander
- (b) When authorized by the Patrol Bureau Commander or the Chief of Police or his designee, the on-duty Watch Commander shall implement the Tactical Mobilization and Deployment Plan. All regular days off shall be canceled. The cancellation of vacation leave or special days off shall be evaluated on an individual basis and canceled in extreme situations only.
- (c) The on-duty Watch Commander shall coordinate all field operations until relieved by the Patrol Bureau Commander.
- (d) All field operations and the deployment of all field personnel and equipment shall be the responsibility of the Patrol Bureau Commander.
- (e) The Department generally will deploy two 12 hour shifts in lieu of any other deployment mode. Shift "A" will commence at 0700 hours and run to 1900 hours; shift "B" from 1900 hours to 0700 hours.
- (f) "A" and "B" shift commanders should consider the need to implement measures to provide for the handling of routine calls for service as well as emergency incidents. Deployment of personnel should reflect consideration for this function within practicable limits.
- (g) Personnel assignment or organizational changes will be made at the discretion of the incident commander.

406.1.4 TACTICAL ALERT

The following organizational plan shall be utilized for a tactical alert. "Tactical Alert" affords us the ability to place additional personnel in the field. However, it is fewer personnel than would be utilized in a full mobilization plan.

406.2 OFF-DUTY REPORTING

Employees off-duty shall, upon official notice, report for duty immediately upon receipt of and in compliance with directions given at the time of notification.

Culver City Police Department

Culver City PD Policy Manual

Mutual Aid & Tactical Mobilization

Employees shall report for duty immediately in the event of any disaster or any other emergency wherein it would be reasonably expected that the Department would require the services of such employee.

Whenever any disaster occurs within the Los Angeles County area, employees shall immediately attempt to contact the on duty Watch Commander to ascertain mobilization status.

If telephone services are out, the employee shall assume that the Department is in full mobilization and respond to the shift (A or B) that they are assigned.

Exception to this policy may include, severe family hardships, roadways blocked or impossible roadway

406.3 DEPLOYMENT

406.3.1 DAY "A" SHIFT (0700-1900 HOURS)

- **Supervisors**
 - Chief of Police
 - Assistant Police Chief (Media Relations)
 - Lt. Professional Standards Unit
 - Lt. Special Operations
 - Lt. Investigations
 - Lt. Day Watch (Both)
 - Sgt. Office of the Chief
 - Sgt. Professional Standards
 - Sgt. Traffic
 - Sgt. P.&T.
 - Sgt. Adult Detectives
 - Parking Supervisor
- **Officers**
 - Day Watch Officers
 - Day Watch K-9 (senior K9)
- **Detectives**
 - Adult Detectives
- **Traffic Section**
 - Day Watch Traffic Officers
 - Commercial Enforcement Officers
 - Accident Investigator

Culver City Police Department

Culver City PD Policy Manual

Mutual Aid & Tactical Mobilization

- **Professional Staff**
 - Day Watch Jailers
 - Senior Management Analyst/Management Analysts
- **Community Service Officers**
 - Day Watch C.S.O.
 - Traffic C.S.O.s
- **Parking Enforcement Officers**
 - P.E.O.s
- **Forensic Specialists**
 - Forensic Specialist (Senior)
- **Records Technicians**
 - Records/Property Supervisor
 - Day Watch Records Technicians
- **Property Technician**
 - Property Technician (Senior)
- **Computer Services Technician**
 - Computer Services Technician (Senior)
- **Custodian**
 - Custodian
- **Secretaries**
 - Chief's Secretary
 - Automated Enforcement Technician

406.3.2 NIGHT "B" SHIFT (1900-0700 HOURS)

- **Supervisors**
 - Captain Patrol Bureau
 - Captain Special Operations Bureau
 - Lt. Morning Watch Ops. (Both)
 - Lt. Administrative
 - Morning Watch
 - Sgt. C.I.T.
 - Sgt. Admin
 - Sgt. LA IMPACT

Culver City Police Department

Culver City PD Policy Manual

Mutual Aid & Tactical Mobilization

- **Officers**
 - Morning Watch
 - Night Watch
 - Morning Watch K-9
- **Detectives**
 - Special Victims Unit Detectives
 - S.R.O.
 - C.I.T.
- **Task Force Personnel**
 - L.A. IMPACT
 - Westside High-Tech Task Force Detective
- **Professional Staff**
 - Night Watch Jailers
- **Forensic Specialists**
 - Forensic Specialists (Junior)
- **Records Technicians**
 - Night Watch Records Technicians
- **Property Technicians**
 - Property Technician (Junior)
- **Computer Services Technicians**
 - Computer Services Technician
- **Custodian**
 - Custodian

Ride-Along Policy

407.1 PURPOSE AND SCOPE

The Ride-Along Program provides an opportunity for citizens to experience the law enforcement function first hand. This policy provides the requirements, approval process, and hours of operation for the Ride-Along Program.

407.1.1 ELIGIBILITY

The Culver City Police Department Ride-Along Program is offered to residents, students and those employed within the City. Every attempt will be made to accommodate interested persons however any applicant may be disqualified without cause.

The following factors may be considered in disqualifying an applicant and are not limited to:

- Being under 15 years of age
- Prior criminal history
- Pending criminal action
- Pending lawsuit against the Department or any other law enforcement agency.
- Denial by any supervisor

407.1.2 AVAILABILITY

The Ride-Along Program is available on most days of the week, with certain exceptions. The ride-along times are from 10:00 a.m. to 11:00 p.m. Exceptions to this schedule may be made as approved by the Chief of Police, Bureau Commander, or Watch Commander.

407.2 PROCEDURE TO REQUEST A RIDE-ALONG

Generally, ride-along requests will be scheduled by the Watch Commander. The participant will complete a ride-along waiver form. Information requested will include a valid ID or California driver's license, address, and telephone number. If the participant is under 18 years of age, a parent/guardian must be present to complete the Ride-Along Form.

The Watch Commander will schedule a date, based on availability, at least one week after the date of application. If approved, a copy will be forwarded to the respective Watch Commander as soon as possible for his/her scheduling considerations.

If the ride-along is denied after the request has been made, a representative of the Department will contact the applicant and advise him/her of the denial.

407.2.1 PROGRAM REQUIREMENTS

Once approved, civilian ride-alongs will be allowed to ride no more than once every six months. An exception would apply to the following: Community Service Officers employed by the Department, Explorers, VIP, Chaplains, Reserves, police applicants, and all others with approval of the Watch Commander.

Culver City Police Department

Culver City PD Policy Manual

Ride-Along Policy

An effort will be made to ensure that no more than one citizen will participate in a ride-along during any given time period. Normally, no more than one ride-along will be allowed in the officer's vehicle at a given time.

407.2.2 SUITABLE ATTIRE

Any person approved to ride along is required to be suitably dressed in collared shirt, blouse or jacket, slacks and shoes. Sandals, T-shirts, tank tops, shorts and ripped or torn blue jeans are not permitted. Hats and ball caps will not be worn in the police vehicle. The Watch Commander or field supervisor may refuse a ride along to anyone not properly dressed.

407.2.3 PEACE OFFICER RIDE-ALONGS

Off-duty members of this department or any other law enforcement agency will not be permitted to ride-along with on-duty officers without the expressed consent of the Watch Commander. In the event that such a ride-along is permitted, the off-duty employee shall not be considered on-duty and shall not represent themselves as a peace officer or participate in any law enforcement activity except as emergency circumstances may require.

407.2.4 RIDE-ALONG CRIMINAL HISTORY CHECK

All Ride-along applicants are subject to a criminal history check. The criminal history check may include a local records check and a Department of Justice Automated Criminal History System check through CLETS prior to their approval as a ride-along with a law enforcement officer (provided that the ride-along is not an employee of the Culver City Police Department) (CLETS Policies, Practices and Procedures Manual § 1.6.1.F.2.).

407.3 OFFICER'S RESPONSIBILITY

The officer shall advise the dispatcher that a ride-along is present in the vehicle before going into service. Officers shall consider the safety of the ride-along at all times. Officers should use sound discretion when encountering a potentially dangerous situation, and if feasible, let the participant out of the vehicle in a well-lighted place of safety. The dispatcher will be advised of the situation and as soon as practical have another police unit respond to pick up the participant at that location. The ride-along may be continued or terminated at this time.

The Watch Commander is responsible for maintaining and scheduling ride-alongs.

407.4 CONTROL OF RIDE-ALONG

The assigned employee shall maintain control over the ride-along at all times and instruct him/her in the conditions that necessarily limit their participation. These instructions should include:

- (a) The ride-along will follow the directions of the officer
- (b) The ride-along will not become involved in any investigation, handling of evidence, discussions with victims or suspects, or handling any police equipment
- (c) The ride-along may terminate the ride at any time and the officer may return the observer to their home or to the station if the ride-along interferes with the performance of the officer's duties

Culver City Police Department

Culver City PD Policy Manual

Ride-Along Policy

- (d) Ride-alongs may be allowed to continue riding during the transportation and booking process provided this does not jeopardize their safety
- (e) Officers will not allow any ride-alongs to be present in any residences or situations that would jeopardize their safety or cause undue stress or embarrassment to a victim or any other citizen
- (f) Under no circumstance shall a civilian ride along be permitted to enter a private residence with an officer without the expressed consent of the resident or other authorized person

Hazardous Material Response

408.1 PURPOSE AND SCOPE

Exposure to hazardous materials presents potential harm to department members and the public. This policy outlines the responsibilities of members who respond to these events and the factors that should be considered while on-scene, including the reporting of exposures and supervisor responsibilities. To comply with 8 CCR § 5194, the following is to be the policy of this department.

408.1.1 DEFINITIONS

Definitions related to this policy include:

Hazardous material – A substance which, by its nature, containment, or reactivity, has the capability of inflicting harm during exposure; characterized as being toxic, corrosive, flammable, reactive, an irritant or strong sensitizer and thereby posing a threat to health when improperly managed.

408.2 HAZARDOUS MATERIAL RESPONSE

Members may encounter situations involving suspected hazardous materials, such as at the scene of a traffic accident, chemical spill, or fire. When members come into contact with a suspected hazardous material, certain steps should be taken to protect themselves and citizens.

The following steps should be considered at any scene involving suspected hazardous materials:

- (a) Attempt to identify the type of hazardous substance. (Identification can be determined by placard, driver's manifest, or statements from the person transporting).
- (b) Notify the fire department.
- (c) Provide first-aid for injured parties if it can be done safely and without contamination.
- (d) Begin evacuation of the immediate area and surrounding areas, depending on the substance. Voluntary evacuation should be considered; however, depending on the substance, mandatory evacuation may be necessary.
- (e) Notify the local health authority. Such notification is mandatory when a spilled or released item is a pesticide (Health and Safety Code § 105215).
- (f) Notify the Department of Toxic Substances Control. This is mandatory when an officer comes in contact with, or is aware of, the presence of a suspected hazardous substance at a site where an illegal controlled substance is or was manufactured (Health and Safety Code § 79355).

408.3 REPORTING EXPOSURE

Department members who believe that they have been exposed to a hazardous material shall immediately report the exposure to a supervisor. Each exposure shall be documented by the member in an employee memorandum that shall be forwarded via chain of command to the Watch Commander as soon as practicable. Should the affected member be unable to document the exposure for any reason, it shall be the responsibility of the notified supervisor to complete the report.

Culver City Police Department

Culver City PD Policy Manual

Hazardous Material Response

Injury or illness caused or believed to be caused from exposure to hazardous materials shall be reported the same as any other on-duty injury or illness in addition to a crime report or incident report as applicable.

408.3.1 SUPERVISOR RESPONSIBILITY

When a supervisor has been informed that a member has been exposed to a hazardous material, the supervisor shall ensure that immediate medical treatment is obtained and appropriate action is taken to lessen the exposure.

To ensure the safety of members, safety equipment is available through supervisory personnel. Safety items not maintained by the Department will be obtained through the fire department.

Hostage and Barricade Incidents

409.1 PURPOSE AND SCOPE

The purpose of this policy is to provide guidelines for situations where officers have legal cause to contact, detain or arrest a person, and the person refuses to submit to the lawful requests of the officers by remaining in a structure or vehicle and/or by taking a hostage.

The scope of this policy is not intended to address all variables that officers encounter during their initial response or when a hostage or barricade situation has developed. This policy does not require or purport to recommend specific strategies or tactics for resolution as each incident is a dynamic and rapidly evolving event.

409.1.1 DEFINITIONS

Definitions related to this policy include:

Barricade situation - An incident where a person maintains a position of cover or concealment and ignores or resists law enforcement personnel, and it is reasonable to believe the subject is armed with a dangerous or deadly weapon.

Hostage situation - An incident where it is reasonable to believe a person is:

- (a) Unlawfully held by a hostage-taker as security so that specified terms or conditions will be met.
- (b) Unlawfully held against his/her will under threat or actual use of force.

409.2 POLICY

It is the policy of the Culver City Police Department to address hostage and barricade situations with due regard for the preservation of life and balancing the risk of injury, while obtaining the safe release of hostages, apprehending offenders and securing available evidence.

409.3 COMMUNICATION

When circumstances permit, initial responding officers should try to establish and maintain lines of communication with a barricaded person or hostage-taker. Officers should attempt to identify any additional subjects, inquire about victims and injuries, seek the release of hostages, gather intelligence information, identify time-sensitive demands or conditions and obtain the suspect's surrender.

When available, department-authorized negotiators should respond to the scene as soon as practicable and assume communication responsibilities. Negotiators are permitted to exercise flexibility in each situation based upon their training, the circumstances presented, suspect actions or demands and the available resources.

409.3.1 EMERGENCY COMMUNICATIONS

Only an officer who has been designated by the District Attorney or Attorney General may use or authorize the use of an electronic amplifying or recording device to eavesdrop on or record,

Culver City Police Department

Culver City PD Policy Manual

Hostage and Barricade Incidents

or both, oral communication in response to an emergency situation involving a hostage or the barricading of a location, and only when (Penal Code § 633.8(b)):

- (a) The officer reasonably determines an emergency situation exists that involves the immediate danger of death or serious physical injury to any person within the meaning of 18 USC § 2518(7)(a)(i),
- (b) The officer reasonably determines that the emergency situation requires that eavesdropping on oral communication occur immediately, and
- (c) There are grounds upon which an order could be obtained pursuant to 18 USC § 2516(2).
- (d) An application for an order approving the eavesdropping and complying with the requirements of Penal Code § 629.50 is made within 48 hours of the beginning of the eavesdropping.
- (e) The contents of any oral communications overheard are recorded on tape or other comparable device.

409.4 FIRST RESPONDER CONSIDERATIONS

First responding officers should promptly and carefully evaluate all available information to determine whether an incident involves, or may later develop into, a hostage or barricade situation.

The first responding officer should immediately request a supervisor's response as soon as it is determined that a hostage or barricade situation exists. The first responding officer shall assume the duties of the supervisor until relieved by a supervisor or a more qualified responder. The officer shall continually evaluate the situation, including the level of risk to officers, to the persons involved and to bystanders, and the resources currently available.

The handling officer should brief the arriving supervisor of the incident, including information about suspects and victims, the extent of any injuries, additional resources or equipment that may be needed, and current perimeters and evacuation areas.

409.4.1 BARRICADE SITUATION

Unless circumstances require otherwise, officers handling a barricade situation should attempt to avoid a forceful confrontation in favor of stabilizing the incident by establishing and maintaining lines of communication while awaiting the arrival of specialized personnel and trained negotiators. During the interim the following options, while not all-inclusive or in any particular order, should be considered:

- (a) Ensure injured persons are evacuated from the immediate threat area if it is reasonably safe to do so. Request medical assistance.
- (b) Assign personnel to a contact team to control the subject should he/she attempt to exit the building, structure or vehicle, and attack, use deadly force, attempt to escape or surrender prior to additional resources arriving.

Culver City Police Department

Culver City PD Policy Manual

Hostage and Barricade Incidents

- (c) Request additional personnel, resources and equipment as needed (e.g., canine team, air support).
- (d) Provide responding emergency personnel with a safe arrival route to the location.
- (e) Evacuate uninjured persons in the immediate threat area if it is reasonably safe to do so.
- (f) Attempt or obtain a line of communication and gather as much information on the subject as possible, including weapons, other involved parties, additional hazards or injuries.
- (g) Establish an inner and outer perimeter as circumstances require and resources permit to prevent unauthorized access.
- (h) Evacuate bystanders, residents and businesses within the inner and then outer perimeter as appropriate. Check for injuries, the presence of other involved subjects, witnesses, evidence or additional information.
- (i) Determine the need for and notify the appropriate persons within and outside the Department, such as command officers and the Public Information Officer (PIO).
- (j) If necessary and available, establish a tactical or exclusive radio frequency for the incident.
- (k) Establish a command post.

409.4.2 HOSTAGE SITUATION

Officers presented with a hostage situation should attempt to avoid a forceful confrontation in favor of controlling the incident in anticipation of the arrival of specialized personnel and trained hostage negotiators. However, it is understood that hostage situations are dynamic and can require that officers react quickly to developing or changing threats. The following options, while not all-inclusive or in any particular order, should be considered:

- (a) Ensure injured persons are evacuated from the immediate threat area if it is reasonably safe to do so. Request medical assistance.
- (b) Assign personnel to a contact team to control the subject should he/she attempt to exit the building, structure or vehicle, and attack, use deadly force, attempt to escape or surrender prior to additional resources arriving.
- (c) Establish a rapid response team in the event it becomes necessary to rapidly enter a building, structure or vehicle, such as when the suspect is using deadly force against any hostages (see the Rapid Response and Deployment Policy).
- (d) Assist hostages or potential hostages to escape if it is reasonably safe to do so. Hostages should be kept separated if practicable pending further interview.
- (e) Request additional personnel, resources and equipment as needed (e.g., canine team, air support).
- (f) Provide responding emergency personnel with a safe arrival route to the location.
- (g) Evacuate uninjured persons in the immediate threat area if it is reasonably safe to do so.

Culver City Police Department

Culver City PD Policy Manual

Hostage and Barricade Incidents

- (h) Coordinate pursuit or surveillance vehicles and control of travel routes.
- (i) Attempt to obtain a line of communication and gather as much information about the suspect as possible, including any weapons, victims and their injuries, additional hazards, other involved parties and any other relevant intelligence information.
- (j) Establish an inner and outer perimeter as resources and circumstances permit to prevent unauthorized access.
- (k) Evacuate bystanders, residents and businesses within the inner and then outer perimeter as appropriate. Check for injuries, the presence of other involved subjects, witnesses, evidence or additional information.
- (l) Determine the need for and notify the appropriate persons within and outside the Department, such as command officers and the PIO.
- (m) If necessary and available, establish a tactical or exclusive radio frequency for the incident.

409.5 SUPERVISOR RESPONSIBILITIES

Upon being notified that a hostage or barricade situation exists, the supervisor should immediately respond to the scene, assess the risk level of the situation, establish a proper chain of command and assume the role of Incident Commander until properly relieved. This includes requesting a Emergency Response Unit (ERU) response if appropriate and apprising the ERU Commander of the circumstances. In addition, the following options should be considered:

- (a) Ensure injured persons are evacuated and treated by medical personnel.
 - (b) Ensure the completion of necessary first responder responsibilities or assignments.
 - (c) Request crisis negotiators, specialized units, additional personnel, resources or equipment as appropriate.
 - (d) Establish a command post location as resources and circumstances permit.
 - (e) Designate assistants who can help with intelligence information and documentation of the incident.
 - (f) If it is practicable to do so, arrange for video documentation of the operation.
 - (g) Consider contacting utility and communication providers to restrict such services (e.g., restricting electric power, gas, telephone service).
1. When considering restricting communication services, a supervisor should make the determination that there is reason to believe an emergency situation exists involving immediate danger of death or great bodily harm and that an interruption to communication services is necessary to protect public safety (Penal Code § 11471). The supervisor must ensure the Department obtains a court order, in accordance with Penal Code § 11472, prior to requesting the interruption. In the case of an extreme emergency when there is insufficient time to obtain an order prior to the request, application for the order must be submitted within six hours after initiating the interruption. If six hours is not possible, then the application for the court order shall be made at the first reasonably available opportunity, but no later than 24 hours in accordance with Penal Code § 11475.

Culver City Police Department

Culver City PD Policy Manual

Hostage and Barricade Incidents

- (h) Ensure adequate law enforcement coverage for the remainder of the City during the incident. The supervisor should direct non-essential personnel away from the scene unless they have been summoned by the supervisor or Southbay RCC.
- (i) Identify a media staging area outside the outer perimeter and have the department Public Information Officer or a designated temporary media representative provide media access in accordance with the Media Relations Policy.
- (j) Identify the need for mutual aid and the transition or relief of personnel for incidents of extended duration.
- (k) Debrief personnel and review documentation as appropriate.

409.6 REPORTING

Unless otherwise relieved by a supervisor or Incident Commander, the handling officer at the scene is responsible for completion and/or coordination of incident reports.

Response to Bomb Calls

410.1 PURPOSE AND SCOPE

The purpose of this policy is to provide guidelines to assist members of the Culver City Police Department in their initial response to incidents involving explosives, explosive devices, explosion/bombing incidents or threats of such incidents. Under no circumstances should these guidelines be interpreted as compromising the safety of first responders or the public. When confronted with an incident involving explosives, safety should always be the primary consideration.

410.2 POLICY

It is the policy of the Culver City Police Department to place a higher priority on the safety of persons and the public over damage or destruction to public or private property.

410.3 RECEIPT OF BOMB THREAT

Department members receiving a bomb threat should obtain as much information from the individual as reasonably possible, including the type, placement and alleged detonation time of the device.

If the bomb threat is received on a recorded line, reasonable steps should be taken to ensure that the recording is preserved in accordance with established department evidence procedures.

The member receiving the bomb threat should ensure that the Watch Commander is immediately advised and informed of the details. This will enable the Watch Commander to ensure that the appropriate personnel are dispatched, and, as appropriate, the threatened location is given an advance warning.

410.4 GOVERNMENT FACILITY OR PROPERTY

A bomb threat targeting a government facility may require a different response based on the government agency.

410.4.1 CULVER CITY POLICE DEPARTMENT FACILITY

If the bomb threat is against the Culver City Police Department facility, the Watch Commander will direct and assign officers as required for coordinating a general building search or evacuation of the police department, as he/she deems appropriate.

410.4.2 OTHER COUNTY OR MUNICIPAL FACILITY OR PROPERTY

If the bomb threat is against a county or municipal facility within the jurisdiction of the Culver City Police Department that is not the property of this department, the appropriate agency will be promptly informed of the threat. Assistance to the other entity may be provided as the Watch Commander deems appropriate.

Culver City Police Department

Culver City PD Policy Manual

Response to Bomb Calls

410.4.3 FEDERAL BUILDING OR PROPERTY

If the bomb threat is against a federal building or property, the Federal Protective Service should be immediately notified. The Federal Protective Service provides a uniformed law enforcement response for most facilities, which may include use of its Explosive Detector Dog teams.

If the bomb threat is against a federal government property where the Federal Protective Service is unable to provide a timely response, the appropriate facility's security or command staff should be notified.

Bomb threats against a military installation should be reported to the military police or other military security responsible for the installation.

410.5 PRIVATE FACILITY OR PROPERTY

When a member of this department receives notification of a bomb threat at a location in the City of Culver City, the member receiving the notification should obtain as much information as reasonably possible from the notifying individual, including:

- (a) The location of the facility.
- (b) The nature of the threat.
- (c) Whether the type and detonation time of the device is known.
- (d) Whether the facility is occupied and, if so, the number of occupants currently on-scene.
- (e) Whether the individual is requesting police assistance at the facility.
- (f) Whether there are any internal facility procedures regarding bomb threats in place, such as:
 1. No evacuation of personnel and no search for a device.
 2. Search for a device without evacuation of personnel.
 3. Evacuation of personnel without a search for a device.
 4. Evacuation of personnel and a search for a device.

The member receiving the bomb threat information should ensure that the Watch Commander is immediately notified so that he/she can communicate with the person in charge of the threatened facility.

410.5.1 ASSISTANCE

The Watch Commander should be notified when police assistance is requested. The Watch Commander will make the decision whether the Department will render assistance and at what level. Information and circumstances that indicate a reasonably apparent, imminent threat to the safety of either the facility or the public may require a more active approach, including police control over the facility.

Should the Watch Commander determine that the Department will assist or control such an incident, he/she will determine:

- (a) The appropriate level of assistance.

Culver City Police Department

Culver City PD Policy Manual

Response to Bomb Calls

- (b) The plan for assistance.
- (c) Whether to evacuate and/or search the facility.
- (d) Whether to involve facility staff in the search or evacuation of the building.
 - 1. The person in charge of the facility should be made aware of the possibility of damage to the facility as a result of a search.
 - 2. The safety of all participants is the paramount concern.
- (e) The need for additional resources, including:
 - 1. Notification and response, or standby notice, for fire and emergency medical services.

Even though a facility does not request police assistance to clear the interior of a building, based upon the circumstances and known threat, officers may be sent to the scene to evacuate other areas that could be affected by the type of threat, or for traffic and pedestrian control.

410.6 FOUND DEVICE

When handling an incident involving a suspected explosive device, the following guidelines, while not all inclusive, should be followed:

- (a) No known or suspected explosive item should be considered safe regardless of its size or apparent packaging.
- (b) The device should not be touched or moved except by the bomb squad or military explosive ordnance disposal team.
- (c) Personnel should not transmit on any equipment that is capable of producing radio frequency energy within the evacuation area around the suspected device. This includes the following:
 - 1. Two-way radios
 - 2. Cell phones
 - 3. Other personal communication devices
- (d) The appropriate bomb squad or military explosive ordnance disposal team should be summoned for assistance.
- (e) The largest perimeter reasonably possible should initially be established around the device based upon available personnel and the anticipated danger zone.
- (f) A safe access route should be provided for support personnel and equipment.
- (g) Search the area for secondary devices as appropriate and based upon available resources.
- (h) Consider evacuation of buildings and personnel near the device or inside the danger zone and the safest exit route.
- (i) Promptly relay available information to the Watch Commander including:
 - 1. The time of discovery.

Culver City Police Department

Culver City PD Policy Manual

Response to Bomb Calls

2. The exact location of the device.
3. A full description of the device (e.g., size, shape, markings, construction).
4. The anticipated danger zone and perimeter.
5. The areas to be evacuated or cleared.

410.7 EXPLOSION/BOMBING INCIDENTS

When an explosion has occurred, there are multitudes of considerations which may confront the responding officers. As in other catastrophic events, a rapid response may help to minimize injury to victims, minimize contamination of the scene by gathering crowds, or minimize any additional damage from fires or unstable structures.

410.7.1 CONSIDERATIONS

Officers responding to explosions, whether accidental or a criminal act, should consider the following actions:

- (a) Assess the scope of the incident, including the number of victims and extent of injuries.
- (b) Request additional personnel and resources, as appropriate.
- (c) Assist with first aid.
- (d) Identify and take appropriate precautions to mitigate scene hazards, such as collapsed structures, bloodborne pathogens and hazardous materials.
- (e) Assist with the safe evacuation of victims, if possible.
- (f) Establish an inner perimeter to include entry points and evacuation routes. Search for additional or secondary devices.
- (g) Preserve evidence.
- (h) Establish an outer perimeter and evacuate if necessary.
- (i) Identify witnesses.

410.7.2 NOTIFICATIONS

When an explosion has occurred, the following people should be notified as appropriate:

- Fire department
- Bomb squad
- Additional department personnel, such as investigators and forensic services
- Field supervisor
- Watch Commander
- Other law enforcement agencies, including local, state or federal agencies, such as the FBI and the Bureau of Alcohol, Tobacco, Firearms and Explosives (ATF)
- Other government agencies, as appropriate

Culver City Police Department

Culver City PD Policy Manual

Response to Bomb Calls

410.7.3 CROWD CONTROL

Only authorized members with a legitimate need should be permitted access to the scene. Spectators and other unauthorized individuals should be restricted to a safe distance as is reasonably practicable given the available resources and personnel.

410.7.4 PRESERVATION OF EVIDENCE

As in any other crime scene, steps should immediately be taken to preserve the scene. The Watch Commander should assign officers to protect the crime scene area, which could extend over a long distance. Consideration should be given to the fact that evidence may be imbedded in nearby structures or hanging in trees and bushes.

Mental Illness Commitments

411.1 PURPOSE AND SCOPE

This policy provides guidelines for when officers may take a person into custody for psychiatric evaluation and treatment (5150 commitment) (Welfare and Institutions Code § 5150).

411.2 POLICY

It is the policy of the Culver City Police Department to protect the public and individuals through legal and appropriate use of the 72-hour treatment and evaluation commitment (5150 commitment) process.

411.3 AUTHORITY

An officer having probable cause may take a person into custody and place the person in an approved mental health facility for 72-hour treatment and evaluation when the officer believes that, as a result of a mental disorder, the person is a danger to him/herself or others or the person is gravely disabled (Welfare and Institutions Code § 5150; Welfare and Institutions Code § 5585.50).

When determining whether to take a person into custody, officers are not limited to determining the person is an imminent danger and shall consider reasonably available information about the historical course of the person's mental disorder, which may include evidence presented from any of the following (Welfare and Institutions Code § 5150; Welfare and Institutions Code § 5150.05):

- (a) An individual who is providing or has provided mental health treatment or related support services to the person
- (b) A family member
- (c) The person subject to the determination or anyone designated by the person

411.3.1 VOLUNTARY EVALUATION

If an officer encounters an individual who may qualify for a 5150 commitment, the officer may inquire as to whether the person desires to voluntarily be evaluated at an appropriate facility. If the person so desires, the officers should:

- (a) Transport the person to an appropriate facility that is able to conduct the evaluation and admit the person pursuant to a 5150 commitment.
- (b) Document the circumstances surrounding the individual's desire to pursue voluntary evaluation and/or admission.

If at any point the person changes their mind regarding voluntary evaluation, officers should proceed with the 5150 commitment, if appropriate.

411.3.2 RESTRAINTS

If the patient is violent or potentially violent, the officer will notify the staff of this concern. The staff member in charge will have discretion as to whether soft-restraints will be used. If these restraints are desired, the officer will wait while they are being applied to help provide physical control of the patient, if needed.

Culver City Police Department

Culver City PD Policy Manual

Mental Illness Commitments

411.3.3 MENTAL HEALTH DOCUMENTATION

The officer will complete an Application For 72-Hour Detention for Evaluation and Treatment form (MH-302) and provide it to the staff member assigned to that patient. The officer will retain a copy of the 72-hour evaluation for inclusion in the case report. The officer shall also provide a verbal summary to an emergency department staff member regarding the circumstances leading to the involuntary detention.

411.4 CONSIDERATIONS AND RESPONSIBILITIES

Any officer handling a call involving an individual who may qualify for a 5150 commitment should consider, as time and circumstances reasonably permit:

- (a) Available information that might assist in determining the cause and nature of the person's action or stated intentions.
- (b) Community or neighborhood mediation services.
- (c) Conflict resolution and de-escalation techniques.
- (d) Community or other resources available to assist in dealing with mental health issues.

While these steps are encouraged, nothing in this section is intended to dissuade officers from taking reasonable action to ensure the safety of the officers and others.

Officers should consider a 5150 commitment over arrest when mental health issues appear to be a mitigating factor for people who are suspected of committing minor crimes or creating other public safety issues.

411.4.1 SECURING OF PROPERTY

When a person is taken into custody for evaluation, or within a reasonable time thereafter, and unless a responsible relative, guardian or conservator is in possession of the person's personal property, the officer shall take reasonable precautions to safeguard the individual's personal property in his/her possession or on the premises occupied by the person (Welfare and Institutions Code § 5150).

The officer taking the person into custody shall provide a report to the court that describes the person's property and its disposition in the format provided in Welfare and Institutions Code § 5211, unless a responsible person took possession of the property, in which case the officer shall only include the name of the responsible person and the location of the property (Welfare and Institutions Code § 5150).

411.5 TRANSPORTATION

When transporting any individual for a 5150 commitment, the transporting officer should have Southbay RCC notify the receiving facility of the estimated time of arrival, the level of cooperation of the individual and whether any special medical care is needed.

Officers may transport individuals in a patrol unit and shall secure them in accordance with the Handcuffing and Restraints Policy. Should the detainee require transport in a medical transport

Culver City Police Department

Culver City PD Policy Manual

Mental Illness Commitments

vehicle and the safety of any person, including the detainee, requires the presence of an officer during the transport, Watch Commander approval should be sought before transport commences.

411.5.1 RETURN OF CONFISCATED FIREARMS AND WEAPONS

- (a) Whenever the handling officer has cause to believe that the future return of any confiscated weapon(s) might endanger the person or others, the officer shall detail those facts and circumstances in a report. The report shall be forwarded to the Investigations Bureau which shall be responsible for initiating a petition to the superior court for a hearing in accordance with Welfare and Institutions Code § 8102(b), to determine whether or not the weapon(s) will be returned.
- (b) The petition to the Superior Court shall be initiated within 30 days of the release of the individual from whom such weapon(s) have been confiscated unless the Department makes an ex parte application to the court to extend the time to file such a petition, up to a maximum of 60 days. At the time any such petition is initiated, the Department shall send written notice to the individual informing him or her of the right to a hearing on the issue and that he or she has 30 days to confirm with the court clerk any desire for a hearing and that the failure to do so will result in the forfeiture of any confiscated weapon(s).
- (c) If no petition is initiated within the above period, the Department shall make the weapon(s) available for return in accordance with subsection (d) below. If the person does not confirm a desire for a hearing within the prescribed 30 days, the Department may file a petition for an order of default.
- (d) Under no circumstances shall any firearm be returned to any individual unless and until such person presents valid identification and written notification from the California Department of Justice which conforms to the provisions of Penal Code § 12021.3(e).
- (e) In no case in which a firearm or other deadly weapon is not retained as evidence shall the Department be required to retain such firearms or other deadly weapon longer than 180 days after notice has been provided to the owner that such firearm or other deadly weapon is available for return. At the expiration of such period, the firearm or other deadly weapon may be processed for disposal in accordance with applicable law (Penal Code § 12021.3(g)).

411.6 TRANSFER TO APPROPRIATE FACILITY

Upon arrival at the facility, the officer will escort the individual into a treatment area designated by a facility staff member. If the individual is not seeking treatment voluntarily, the officer should provide the staff member with the written application for a 5150 commitment and remain present to provide clarification of the grounds for detention, upon request.

Absent exigent circumstances, the transporting officer should not assist facility staff with the admission process, including restraint of the individual. However, if the individual is transported and delivered while restrained, the officer may assist with transferring the individual to facility

Culver City Police Department

Culver City PD Policy Manual

Mental Illness Commitments

restraints and will be available to assist during the admission process, if requested. Under normal circumstances, officers will not apply facility-ordered restraints.

411.7 DOCUMENTATION

The officer shall complete an application for a 72-Hour detention for evaluation and treatment, provide it to the facility staff member assigned to that patient and retain a copy of the application for inclusion in the case report.

The application shall include the circumstances for officer involvement; the probable cause to believe the person is, as a result of a mental health disorder, a danger to others or him/herself or gravely disabled; and all information used for the determination of probable cause (Welfare and Institutions Code § 5150; Welfare and Institutions Code § 5150.05).

The officer should also provide a verbal summary to any evaluating staff member regarding the circumstances leading to the involuntary detention.

411.7.1 ADVISEMENT

The officer taking a person into custody for evaluation shall advise the person of:

- (a) The officer's name and agency.
- (b) The fact that the person is not under criminal arrest but is being taken for examination by mental health professionals and the mental health staff will advise him/her of their rights.
- (c) The name of the facility to which the person is being taken.
- (d) If the person is being taken into custody at his/her residence, he/she should also be advised that he/she may take a few personal items, which the officer must approve, and may make a telephone call or leave a note indicating where he/she is being taken. The officer should also ask if the person needs assistance turning off any appliance or water.

The advisement shall be given in a language the person understands. If the person cannot understand an oral advisement, the information shall be provided in writing (Welfare and Institutions Code § 5150).

411.8 CRIMINAL OFFENSES

Officers investigating an individual who is suspected of committing a minor criminal offense and who is being taken on a 5150 commitment should resolve the criminal matter by issuing a warning or a Notice to Appear as appropriate.

When an individual who may qualify for a 5150 commitment has committed a serious criminal offense that would normally result in an arrest and transfer to a jail facility, the officer should:

- (a) Arrest the individual when there is probable cause to do so.
- (b) Notify the appropriate supervisor of the facts supporting the arrest and the facts that would support the 5150 commitment.

Culver City Police Department

Culver City PD Policy Manual

Mental Illness Commitments

- (c) Facilitate the individual's transfer to jail.
- (d) Thoroughly document in the related reports the circumstances that indicate the individual may qualify for a 5150 commitment.

In the supervisor's judgment, the individual may instead be arrested or booked and transported to the appropriate mental health facility. The supervisor should consider the seriousness of the offense, the treatment options available, the ability of this department to regain custody of the individual, department resources (e.g., posting a guard) and other relevant factors in making this decision.

411.9 FIREARMS AND OTHER WEAPONS

Whenever a person is taken into custody for a 5150 commitment, the handling officers should seek to determine if the person owns or has access to any firearm or other deadly weapon defined in Welfare and Institutions Code § 8100. Officers should consider whether it is appropriate and consistent with current search and seizure law under the circumstances to seize any such firearms or other dangerous weapons (e.g., safekeeping, evidence, consent).

Officers are cautioned that a search warrant may be needed before entering a residence or other place to search, unless lawful, warrantless entry has already been made (e.g., exigent circumstances, consent). A search warrant may also be needed before searching for or seizing weapons

The handling officers shall issue a receipt describing the deadly weapon or any firearm seized, and list any serial number or other identification that is on the firearm. Officers shall advise the person of the procedure for the return of any firearm or other weapon that has been taken into custody (Welfare and Institutions Code § 8102 (b)) (see the Property and Evidence Section Policy).

411.9.1 PETITION FOR RETURN OF FIREARMS AND OTHER WEAPONS

Whenever the handling officer has cause to believe that the future return of any confiscated weapon might endanger the person or others, the officer shall detail those facts and circumstances in a report. The report shall be forwarded to the Detective Bureau, which shall be responsible for initiating a petition to the Superior Court for a hearing in accordance with Welfare and Institutions Code § 8102(c), to determine whether the weapon will be returned.

The petition to the Superior Court shall be initiated within 30 days of the release of the individual from whom such weapon has been confiscated, unless the Department makes an ex parte application to the court to extend the time to file such a petition, up to a maximum of 60 days. At the time any such petition is initiated, the Department shall send written notice to the individual informing him/her of the right to a hearing on the issue, that he/she has 30 days to confirm with the court clerk any desire for a hearing and that the failure to do so will result in the forfeiture of any confiscated weapon.

Culver City Police Department

Culver City PD Policy Manual

Mental Illness Commitments

411.10 TRAINING

This department will endeavor to provide Peace Officer Standards and Training (POST)-approved advanced officer training on interaction with persons with mental disabilities, 5150 commitments and crisis intervention.

Cite and Release Policy

412.1 PURPOSE AND SCOPE

This policy provides guidance on when to release adults who are arrested for a criminal misdemeanor offense on a written notice to appear (citation) and when to hold for court or bail.

412.2 POLICY

It is the policy of the Culver City Police Department to release all persons arrested on misdemeanor or other qualifying charges on a citation with certain exceptions (Penal Code § 853.6).

If there is a reason for non-release, the Department's mission to protect the community will be the primary consideration when determining whether to release any individual in lieu of holding for court or bail.

412.3 RELEASE BY CITATION

Except in cases where a reason for non-release as described below exists, adults arrested for a misdemeanor offense, including a private person's arrest, shall be released from custody on a citation (Penal Code § 853.6).

The citing officer shall, at the time the defendant signs the notice to appear, call attention to the time and place for appearance and take any other steps they deem necessary to ensure that the defendant understands their written promise to appear.

412.3.1 FIELD CITATIONS

In most cases an adult arrested for a misdemeanor offense may be released in the field on a citation in lieu of physical arrest when booking and fingerprinting is not practicable or immediately required provided the individual can be satisfactorily identified, there is no outstanding arrest warrant for the individual and none of the below described disqualifying circumstances are present (Penal Code § 853.6; Penal Code § 1270.1). In such cases the arresting officer should check the booking required box on the citation form to indicate that the person will be photographed and fingerprinted at a later time when ordered by the court.

When a booking photo or fingerprints are needed for the furtherance of any investigation, the person should be released on citation after booking instead of on a field citation.

412.3.2 RELEASE AFTER BOOKING

In some cases it may not be feasible or desirable to release a person in the field. The person should instead be released on citation after booking at the jail. All bookings shall be approved by the Watch Commander or the authorized designee.

412.3.3 INSTRUCTIONS TO CITED PERSON

The citing officer shall, at the time he/she asks the defendant to sign the notice to appear, call attention to the time and place for appearance and take any other steps he/she deems necessary to ensure that the defendant understands his/her written promise to appear.

Culver City Police Department

Culver City PD Policy Manual

Cite and Release Policy

412.4 NON-RELEASE

412.4.1 DISQUALIFYING OFFENSES

An adult arrested on any of the following disqualifying charges shall not be released on citation and shall be transported to the appropriate detention facility or held for court or bail after booking (Penal Code § 1270.1):

- (a) Misdemeanor domestic battery (Penal Code § 243(e)(1))
- (b) Felony domestic battery (Penal Code § 273.5)
- (c) Serious or violent felonies (Penal Code § 1270.1(a)(1))
- (d) Felony intimidation of witnesses and victims (Penal Code § 136.1)
- (e) Violation of a protective order and the arrested person has made threats, used violence, or has gone to the protected person's workplace or residence (Penal Code § 273.6)
- (f) Stalking (Penal Code § 646.9)
- (g) Misdemeanor violations of a protective order relating to domestic violence if there is a reasonable likelihood the offense will continue or the safety of the individuals or property would be endangered (Penal Code § 853.6)

412.4.2 REASONS FOR NON-RELEASE

A person arrested for a misdemeanor shall be released on a citation unless there is a reason for non-release. The Watch Commander may authorize a release on citation regardless of whether a reason for non-release exists when it is determined to be in the best interest of the Department and does not present an unreasonable risk to the community (e.g., release of an intoxicated or ill person to a responsible adult).

Reasons for non-release include (Penal Code § 853.6(i)):

- (a) The person arrested is so intoxicated that they could be a danger to themselves or to others. Release may occur as soon as this condition no longer exists.
- (b) The person arrested requires medical examination or medical care or is otherwise unable to care for their own safety.
- (c) The person is arrested for one or more of the offenses listed in Vehicle Code § 40302, Vehicle Code § 40303, and Vehicle Code § 40305.
- (d) There are one or more outstanding arrest warrants for the person (see Misdemeanor Warrants elsewhere in this policy).
- (e) The person could not provide satisfactory evidence of personal identification.
 - 1. If a person released on citation does not have satisfactory identification in their possession, a right thumbprint or fingerprint should be obtained on the citation form.

Culver City Police Department

Culver City PD Policy Manual

Cite and Release Policy

- (f) The prosecution of the offense or offenses for which the person was arrested or the prosecution of any other offense or offenses would be jeopardized by the immediate release of the person arrested.
- (g) There is a reasonable likelihood that the offense or offenses would continue or resume, or that the safety of persons or property would be imminently endangered by the release of the person arrested.
- (h) The person arrested demands to be taken before a magistrate or has refused to sign the notice to appear.
- (i) There is reason to believe that the person would not appear at the time and place specified in the notice to appear. The basis for this determination shall be specifically documented. Reasons may include:
 - 1. Previous failure to appear is on record
 - 2. The person lacks ties to the area, such as a residence, job, or family
 - 3. Unusual circumstances lead the officer responsible for the release of arrested persons to conclude that the suspect should be held for further investigation
- (j) A previous conviction, citation, or arrest for misdemeanor or felony retail theft from a store in the previous six months.
- (k) There is probable cause to believe that the person arrested is guilty of committing organized retail theft.

When a person is arrested on a misdemeanor offense and is not released by criminal citation, the reason for non-release shall be noted on the booking form. This form shall be submitted to the Watch Commander for approval and included with the case file in the Records Section.

412.5 MISDEMEANOR WARRANTS

An adult arrested on a misdemeanor warrant may be released, subject to Watch Commander approval, unless any of the following conditions exist:

- (a) The misdemeanor cited in the warrant involves violence.
- (b) The misdemeanor cited in the warrant involves a firearm.
- (c) The misdemeanor cited in the warrant involves resisting arrest.
- (d) The misdemeanor cited in the warrant involves giving false information to a peace officer.
- (e) The person arrested is a danger to themselves or others due to intoxication or being under the influence of drugs or narcotics.
- (f) The person requires medical examination or medical care or was otherwise unable to care for their own safety.
- (g) The person has other ineligible charges pending against themselves.
- (h) There is reasonable likelihood that the offense or offenses would continue or resume, or that the safety of persons or property would be immediately endangered by the release of the person.

Culver City Police Department

Culver City PD Policy Manual

Cite and Release Policy

- (i) The person refuses to sign the notice to appear.
- (j) The person cannot provide satisfactory evidence of personal identification.
- (k) The warrant of arrest indicates that the person is not eligible to be released on a notice to appear.

Release under this section shall be done in accordance with the provisions of this policy.

412.6 JUVENILE CITATIONS

Completion of criminal citations for juveniles is generally not appropriate with the following exceptions:

- Misdemeanor traffic violations of the Vehicle Code
- Violations of the Culver City City codes

All other misdemeanor violations for juveniles shall be documented with a case number and the case should be referred to the Detective Bureau for further action including diversion.

412.7 REQUESTING CASE NUMBERS

Many cases involving a criminal citation release can be handled without requesting a case number. Traffic situations and local code violations can be documented on the reverse side of the records copy of the citation. Most Penal Code sections will require a case number to document the incident properly in a report. This section does not preclude an officer from requesting a case number if the officer feels the situation should be documented more thoroughly in a case report.

Foreign Diplomatic and Consular Representatives

413.1 PURPOSE AND SCOPE

This policy provides guidelines to ensure that members of the Culver City Police Department extend appropriate privileges and immunities to foreign diplomatic and consular representatives in accordance with international law.

413.2 POLICY

The Culver City Police Department respects international laws related to the special privileges and immunities afforded foreign diplomatic and consular representatives assigned to the United States.

All foreign diplomatic and consular representatives shall be treated with respect and courtesy, regardless of any privileges or immunities afforded them.

413.3 CLAIMS OF IMMUNITY

If a member comes into contact with a person where law enforcement action may be warranted and the person claims diplomatic or consular privileges and immunities, the member should, without delay:

- (a) Notify a supervisor.
- (b) Advise the person that his/her claim will be investigated and he/she may be released in accordance with the law upon confirmation of the person's status.
- (c) Request the person's identification card, either issued by the U.S. Department of State (DOS), Office of the Chief of Protocol, or in the case of persons accredited to the United Nations, by the U.S. Mission to the United Nations. These are the only reliable documents for purposes of determining privileges and immunities.
- (d) Contact the DOS Diplomatic Security Command Center at 571-345-3146 or toll free at 866-217-2089, or at another current telephone number and inform the center of the circumstances.
- (e) Verify the immunity status with DOS and follow any instructions regarding further detention, arrest, prosecution and/or release, as indicated by the DOS representative. This may require immediate release, even if a crime has been committed.

Identity or immunity status should not be presumed from the type of license plates displayed on a vehicle. If there is a question as to the status or the legitimate possession of a Diplomat or Consul license plate, a query should be run via the National Law Enforcement Telecommunications System (NLETS), designating "US" as the state.

413.4 ENFORCEMENT

If the DOS is not immediately available for consultation regarding law enforcement action, members shall be aware of the following:

Culver City Police Department

Culver City PD Policy Manual

Foreign Diplomatic and Consular Representatives

- (a) Generally, all persons with diplomatic and consular privileges and immunities may be issued a citation or notice to appear. However, the person may not be compelled to sign the citation.
- (b) All persons, even those with a valid privilege or immunity, may be reasonably restrained in exigent circumstances for purposes of self-defense, public safety or the prevention of serious criminal acts.
- (c) An impaired foreign diplomatic or consular representative may be prevented from driving a vehicle, even if the person may not be arrested due to privileges and immunities.
 - 1. Investigations, including the request for field sobriety tests, chemical tests and any other tests regarding impaired driving may proceed but they shall not be compelled.
- (d) The following persons may not be detained or arrested, and any property or vehicle owned by these persons may not be searched or seized:
 - 1. Diplomatic-level staff of missions to international organizations and recognized family members
 - 2. Diplomatic agents and recognized family members
 - 3. Members of administrative and technical staff of a diplomatic mission and recognized family members
 - 4. Career consular officers, unless the person is the subject of a felony warrant
- (e) The following persons may generally be detained and arrested:
 - 1. International organization staff; however, some senior officers are entitled to the same treatment as diplomatic agents.
 - 2. Support staff of missions to international organizations
 - 3. Diplomatic service staff and consular employees; however, special bilateral agreements may exclude employees of certain foreign countries.
 - 4. Honorary consular officers
 - 5. Whenever an officer arrests and incarcerates, or detains for investigation for over two hours, a person with diplomatic and consular privileges and immunities, the officer shall promptly advise the person that he/she is entitled to have his/her government notified of the arrest or detention (Penal Code § 834c). If the individual wants his/her government notified, the officer shall begin the notification process.

413.5 DOCUMENTATION

All contacts with persons who have claimed privileges and immunities afforded foreign diplomatic and consular representatives should be thoroughly documented and the related reports forwarded to DOS.

413.6 DIPLOMATIC IMMUNITY TABLE

Reference table on diplomatic immunity:

Culver City Police Department

Culver City PD Policy Manual

Foreign Diplomatic and Consular Representatives

Category	Arrested or Detained	Enter Residence Subject to Ordinary Procedures	Issued Traffic Citation	Subpoenaed as Witness	Prosecuted	Recognized Family Members
Diplomatic Agent	No (note (b))	No	Yes	No	No	Same as sponsor (full immunity & inviolability)
Member of Admin and Tech Staff	No (note (b))	No	Yes	No	No	Same as sponsor (full immunity & inviolability)
Service Staff	Yes (note (a))	Yes	Yes	Yes	No for official acts. Yes otherwise (note (a))	No immunity or inviolability (note (a))
Career Consul Officer	Yes if for a felony and pursuant to a warrant (note (a))	Yes (note (d))	Yes	No for official acts Testimony may not be compelled in any case	No for official acts. Yes otherwise (note (a))	No immunity or inviolability
Honorable Consul Officer	Yes	Yes	Yes	No for official acts Yes otherwise.	No for official acts Yes otherwise	No immunity or inviolability
Consulate Employees	Yes (note (a))	Yes	Yes	No for official acts Yes otherwise.	No for official acts. Yes otherwise (note (a))	No immunity or inviolability (note (a))
Int'l Org Staff (note (b))	Yes (note (c))	Yes (note (c))	Yes	Yes (note (c))	No for official acts. Yes otherwise (note (c))	No immunity or inviolability
Diplomatic-Level Staff of Missions to Int'l Org	No (note (b))	No	Yes	No	No	Same as sponsor (full immunity & inviolability)
Support Staff of Missions to Int'l Orgs	Yes	Yes	Yes	Yes	No for official acts Yes otherwise	No immunity or inviolability

Notes for diplomatic immunity table:

Culver City Police Department

Culver City PD Policy Manual

Foreign Diplomatic and Consular Representatives

- (a) This table presents general rules. The employees of certain foreign countries may enjoy higher levels of privileges and immunities on the basis of special bilateral agreements.
- (b) Reasonable constraints, however, may be applied in emergency circumstances involving self-defense, public safety, or in the prevention of serious criminal acts.
- (c) A small number of senior officers are entitled to be treated identically to diplomatic agents.
- (d) Note that consul residences are sometimes located within the official consular premises. In such cases, only the official office space is protected from police entry.

Rapid Response and Deployment

414.1 PURPOSE AND SCOPE

Violence that is committed in schools, workplaces and other locations by individuals or a group of individuals who are determined to target and kill persons and to create mass casualties presents a difficult situation for law enforcement. The purpose of this policy is to identify guidelines and factors that will assist responding officers in situations that call for rapid response and deployment.

414.2 POLICY

The Culver City Police Department will endeavor to plan for rapid response to crisis situations, and to coordinate response planning with other emergency services as well as with those that are responsible for operating sites that may be the target of a critical incident.

Nothing in this policy shall preclude the use of reasonable force, deadly or otherwise, by members of the Department in protecting themselves or others from death or serious injury.

414.3 FIRST RESPONSE

If there is a reasonable belief that acts or threats by a suspect are placing lives in imminent danger, first responding officers should consider reasonable options to reduce, prevent or eliminate the threat. Officers must decide, often under a multitude of difficult and rapidly evolving circumstances, whether to advance on the suspect, take other actions to deal with the threat or wait for additional resources.

If a suspect is actively engaged in the infliction of serious bodily harm or other life-threatening activity toward others, officers should take immediate action, if reasonably practicable, while requesting additional assistance.

Officers should remain aware of the possibility that an incident may be part of a coordinated multi-location attack that may require some capacity to respond to other incidents at other locations.

When deciding on a course of action officers should consider:

- (a) Whether to advance on or engage a suspect who is still a possible or perceived threat to others. Any advance or engagement should be based on information known or received at the time.
- (b) Whether to wait for additional resources or personnel. This does not preclude an individual officer from taking immediate action.
- (c) Whether individuals who are under imminent threat can be moved or evacuated with reasonable safety.
- (d) Whether the suspect can be contained or denied access to victims.
- (e) Whether the officers have the ability to effectively communicate with other personnel or resources.
- (f) Whether planned tactics can be effectively deployed.

Culver City Police Department

Culver City PD Policy Manual

Rapid Response and Deployment

- (g) The availability of rifles, shotguns, shields, breaching tools, control devices and any other appropriate tools, and whether the deployment of these tools will provide a tactical advantage.

In a case of a barricaded suspect with no hostages and no immediate threat to others, officers should consider summoning and waiting for additional assistance (special tactics and/or hostage negotiation team response).

414.3.1 RESPONSE TO SCHOOL THREATS

Upon receiving a threat or perceived threat from a school official that involves grades 6 to 12, officers shall immediately investigate and conduct a threat assessment. The investigation shall include a review of the firearm registry of the California Department of Justice. A reasonable search of the school at issue shall be conducted when the search is justified by reasonable suspicion that it would produce evidence related to the threat or perceived threat (Education Code § 49394).

For purposes of this subsection a "threat" or "perceived threat" means any writing or action of a pupil that creates a reasonable suspicion that the pupil is preparing to commit a homicidal act related to school or a school activity. This may include possession, use, or depictions of firearms, ammunition, shootings, or targets in association with infliction of physical harm, destruction, or death in a social media post, journal, class note, or other media associated with the pupil. It may also include a warning by a parent, pupil, or other individual (Education Code § 49390).

414.4 CONSIDERATIONS

When dealing with a crisis situation members should:

- (a) Assess the immediate situation and take reasonable steps to maintain operative control of the incident.
- (b) Obtain, explore and analyze sources of intelligence and known information regarding the circumstances, location and suspect involved in the incident.
- (c) Attempt to attain a tactical advantage over the suspect by reducing, preventing or eliminating any known or perceived threat.
- (d) Attempt, if feasible and based upon the suspect's actions and danger to others, a negotiated surrender of the suspect and release of the hostages.

414.5 PLANNING

The Emergency Response Team Commander should coordinate critical incident planning. Planning efforts should consider:

- (a) Identification of likely critical incident target sites, such as schools, shopping centers, entertainment and sporting event venues.
- (b) Availability of building plans and venue schematics of likely critical incident target sites.
- (c) Communications interoperability with other law enforcement and emergency service agencies.
- (d) Training opportunities in critical incident target sites, including joint training with site occupants.

Culver City Police Department

Culver City PD Policy Manual

Rapid Response and Deployment

- (e) Evacuation routes in critical incident target sites.
- (f) Patrol first-response training.
- (g) Response coordination and resources of emergency medical and fire services.
- (h) Equipment needs.
- (i) Mutual aid agreements with other agencies.
- (j) Coordination with private security providers in critical incident target sites.

414.6 TRAINING

The Emergency Response Commanders should include rapid response to critical incidents in the training plan. This training should address:

- (a) Orientation to likely critical incident target sites, such as schools, shopping centers, entertainment and sporting event venues.
- (b) Communications interoperability with other law enforcement and emergency service agencies.
- (c) Patrol first-response training, including patrol rifle, shotgun, breaching tool and control device training.
 - (a) This should include the POST terrorism incident training required for officers assigned to field duties (Penal Code § 13519.12).
- (d) First aid, including gunshot trauma.
- (e) Reality-based scenario training (e.g., active shooter, disgruntled violent worker).

Emergency Utility Service

415.1 PURPOSE AND SCOPE

The City Public Works Department has personnel available to handle emergency calls 24 hours per day. Calls for service during non-business hours are frequently directed to the Police Department. Requests for such service received by this department should be handled in the following manner.

415.1.1 BROKEN WATER LINES

The City's responsibility ends at the water meter; any break or malfunction in the water system from the water meter to the citizen's residence or business is the customer's responsibility.^{Public} Works can only turn off the valve at the meter. The citizen can normally accomplish this.

If a break occurs on the City side of the meter, emergency personnel should be called as soon as practical by Southbay RCC.

415.1.2 ELECTRICAL LINES

City Public Works does not maintain electrical lines to street light poles. When a power line poses a hazard, an officer should be dispatched to protect against personal injury or property damage that might be caused by power lines. The Electric Company or Public Works should be promptly notified, as appropriate.

415.1.3 RESERVOIRS, PUMPS, WELLS, ETC.

Public Works maintains the reservoirs and public water equipment, as well as several underpass and other street drainage pumps. In the event of flooding or equipment malfunctions, emergency personnel should be contacted as soon as possible.

415.1.4 EMERGENCY NUMBERS

A current list of emergency personnel who are to be called for municipal utility emergencies is maintained by Southbay RCC and the Watch Commander's Call-Out Book.

415.2 TRAFFIC SIGNAL MAINTENANCE

The City of Culver City maintains all traffic signals within the City, other than those maintained by the State of California.

415.2.1 OFFICER'S RESPONSIBILITY

Upon observing a damaged or malfunctioning signal, the officer will advise the Communications Center of the location and problem with the signal. The dispatcher or the Watch Commander should make the necessary notification to the proper maintenance agency.

Rifle

416.1 PURPOSE AND SCOPE

In order to more effectively and accurately address the increasing level of fire power and body armor utilized by criminal suspects, the Culver City Police Department will make rifles available to qualified officers as an additional and more immediate tactical resource.

416.2 RIFLE DEFINITION

A rifle is an authorized weapon which is owned by the Department and which is made available to properly trained and qualified sworn personnel as a supplemental resource to their duty handgun or shotgun. No personally owned rifles may be carried for patrol duty unless preapproved in writing by the Chief of Police.

All qualified sworn personnel shall carry their Department issued rifle when assigned to a uniformed field assignment. All qualified sworn personnel working a non-uniformed assignment shall have their Department issued rifle immediately available during working hours. The rifle is an additional tool that shall be deployed along with the shotgun.

416.3 SPECIFICATIONS

Only weapons, ammunition, and accessories that meet agency authorized specifications and are approved by the Chief of Police may be used by qualified sworn personnel in their law enforcement responsibilities.

The authorized rifles issued by the Department are the Colt M4 Commando and the LWRCI M6 carbine, in 5.56x45 mm.

The authorized on-duty magazines are either the Magpul or Colt factory magazines for the AR-15 / M4 weapons platform, or a substitute magazine of high quality approved by the Chief of Police or his designee.

The authorized on-duty ammunition is the Hornady 5.56x45mm TAP 75 grain BTHP (8126N). The only ammunition authorized for off-duty training use is the Hornady .223 Remington 75 grain BTHP training round (9760EL), or a substitute BTHP round approved by the Chief of Police or his designee.

416.4 RIFLE MAINTENANCE

(a) Primary responsibility for maintenance of individually issued rifles shall fall on the qualified sworn personnel to whom the rifle was assigned. The Range master or his designee shall conduct bi-annual inspections to ensure Department Specifications and proper maintenance protocols are being adhered to.

(b) Qualified sworn personnel shall conduct a complete inspection of their respective rifles once a month. This inspection will include verification of correct witness mark alignment, weapon light and optical gunsight battery function, proper lubrication and maintenance.

Culver City Police Department

Culver City PD Policy Manual

Rifle

(c) All users of the rifles shall be responsible for promptly reporting to the Range master any damage or malfunction of an assigned rifle. In the event of personnel needing a temporary replacement rifle, a spare rifle(s) will be available in the 3rd Armory. The temporary replacement rifle shall be assigned by the Range master or the Watch Commander.

(d) Each rifle shall be subject to inspection by a supervisor, the Range master or Armorer at any time.

(e) No modification shall be made to any rifle without prior written authorization from the Chief of Police, with the exception of the Trijicon MRO Scopecoat for the carbines mounted on a police motor.

416.5 TRAINING

Qualified sworn personnel shall not carry or utilize the rifle unless they have successfully completed departmentally approved training. This training shall consist of an initial California P.O.S.T. approved operator's course, consisting of no less than 16 hours of instruction and qualification. Qualified sworn personnel shall thereafter be required to re-qualify biannually under the supervision of a certified rifle instructor

416.6 DEPLOYMENT OF THE RIFLE

Qualified sworn personnel may deploy the rifle in any circumstance where the he or she can articulate a reasonable expectation that the rifle may be needed.

Examples of some general guidelines for deploying the rifle may include, but are not limited to:

(a) Situations where the qualified sworn personnel reasonably anticipates an armed encounter, including high risk vehicle stops.

(b) Situations involving a suspect armed in a distant or fortified location that affords tactical superiority.

(c) Situations where qualified sworn personnel reasonably expect the need to meet or exceed a suspect's firepower.

(d) Situations involving a suspect armed with a shoulder fired weapon.

(e) When a qualified sworn personnel reasonably believes that there may be a need to deliver fire on a barricaded suspect or a suspect with a hostage.

(f) When qualified sworn personnel reasonably believe that a suspect may be wearing body armor or shielding material.

(g) Situations involving tactical operations on a search warrant or other detail.

(h) When authorized or requested by a supervisor.

416.7 DISCHARGE OF THE PATROL RIFLE

The discharge of the rifle shall be governed by the Department's Deadly Force Policy, Policy Manual § 300.

Culver City Police Department

Culver City PD Policy Manual

Rifle

416.8 PATROL READY

Qualified sworn personnel carrying a rifle in the field shall maintain the weapon in the "patrol ready" until deployed. A rifle is considered "patrol ready" when it has been inspected by the assigned sworn personnel and meets the following conditions:

- (a) The chamber is empty.
- (b) The rifle bolt is forward and hammer is cocked.
- (c) The selector is placed of on the "SAFE" position.
- (d) There is a Department approved magazine loaded with 28 rounds inserted into the magazine well.
- (e) The dust cover is closed.
- (f) The rifle is stored in the locked patrol vehicle's rifle rack or in its issued storage case, secured in the rear utility area or trunk of the police vehicle

416.9 RIFLE STORAGE

416.9.1 ON-DUTY STORAGE

- (a) Locked in an assigned vehicle's gun rack or in a rifle case, in the trunk.
- (b) Those assigned to desk duties (excluding the Desk Officer), shall secure their respective rifles in the closest weapons storage lockers in the Traffic, Adult and Juvenile Sections of the Department

416.9.2 OFF-DUTY STORAGE

- (a) Ensuring the rifle is appropriately stored and secured is the qualified sworn personnel's responsibility.
- (b) Qualified sworn personnel shall ensure that all firearms and ammunition are locked and secured while in their homes, vehicles or any other area under their control and in a manner that will keep them inaccessible to minors and adults who should not have access (Penal Code Section 25100). Qualified sworn personnel shall not permit department issued firearms to be handled by anyone who is not authorized by the Department. **See STORAGE OF FIREARMS AT HOME, CCPD Duty Manual Section 307.5.2**
- (c) The rifle or any other firearm shall not be left unattended in a vehicle overnight. Qualified sworn personnel with assigned City vehicles shall not leave any Department issued firearm in the vehicle overnight unless parked in a secure, single family garage. The rifle may be locked in the assigned vehicle's gun rack or in a rifle case, in the trunk.
- (d) Those assigned to desk duties (excluding the Desk Officer), shall secure their respective rifles in the closest weapons storage lockers in the Traffic, Adult and Juvenile Sections of the Department.
- (e) Qualified sworn personnel may secure the rifle in their uniform locker.

Culver City Police Department

Culver City PD Policy Manual

Rifle

(f) At home, if a lockable box or gun safe is not available, qualified sworn personnel shall use the Department issued cable lock, inserted through the magazine well and out the ejection port to render the rifle incapable of firing. In this condition, the rifle shall be secured inside the issued storage case, with the main compartment zippers closed by the issued combination padlock.

(g) Qualified sworn personnel shall be aware that negligent storage of a firearm could result in criminal and civil liability under Penal Code Section 25100. Negligent storage of a firearm is also a violation of Department policy (See subsection (b) above).

416.9.3 TRANSPORTATION OF RIFLE

(a) To minimize exposure, damage to the rifle and concern to citizens, qualified sworn personnel transporting a rifle while on or off-duty shall have the rifle concealed in the Department issued storage case.

416.9.4 SAFETY CONSIDERATIONS

(a) Qualified sworn personnel shall not unnecessarily display or handle any rifle.

(b) Qualified sworn personnel shall be governed by all rules and regulations pertaining to the use of the firing range and shall obey all orders issued by their immediate supervisor or the Range master. **See DEPARTMENT FIRING RANGE CCPD Duty Manual Section 308.**

(c) Qualified sworn personnel shall only dry-fire, live-fire, or practice deploying the rifle at a firing range or other location designed or intended for firearms training.

(d) Qualified sworn personnel who discharges their rifle accidentally or intentionally, on or off-duty, excluding training or sporting use, shall report the incident to his or her supervisor or the Watch Commander, per Duty Manual Section 307.7.

(e) Qualified sworn personnel shall not clear the rifle's chamber anywhere at the Department, except when utilizing the red clearing box adjacent to the "Sally Port," in the clearing box in the Firing Range or when safely facing downrange in the Department firing range.

(f) Qualified sworn personnel shall not clean their rifle anywhere in the Department other than in the Department firing range.

416.9.5 OFF-DUTY USE OF THE DEPARTMENT RIFLE

(a) Qualified sworn personnel may use their Department rifle in the station's firing range, public firing ranges and private firing ranges. If personnel are desirous of utilizing their Department issued rifle at competition events, prior written approval by the Chief of Police is required. The cost of ammunition used for off-duty training and/or events shall be the financial responsibility of the qualified sworn personnel.

Shotgun

417.1 PURPOSE AND SCOPE

In order to more effectively and accurately address the increasing level of fire power utilized by criminal suspects, the Culver City Police Department will make shotguns available to qualified officers as an additional and more immediate tactical resource.

417.1.1 SHOTGUN

417.1.2 DEFINITION

Shotguns are authorized weapons which are owned by the Department and which are made available to properly trained and qualified officers as a supplemental resource to their duty handgun. No personally owned shotguns may be carried for patrol duty unless pre-approved in writing by the Chief of Police and the department Rangemaster.

417.1.3 SPECIFICATIONS

Only weapons and ammunition that meet agency authorized specifications, approved by the Chief of Police, and issued by the Department may be used by officers in their law enforcement responsibilities. The authorized shotgun issued by the Department is the 12 gauge Benelli Super 90. The authorized factory ammunition is 12 gauge 2 3/4" buckshot or 1 ounce slug, approved by the Chief of Police.

417.1.4 SHOTGUN MAINTENANCE

- (a) Primary responsibility for maintenance of shotguns shall fall on the Rangemaster or armorer who shall inspect and service each shotgun on a regular basis.
- (b) Each patrol officer shall be responsible for promptly reporting any damage or malfunction of an assigned shotgun.
- (c) Each shotgun shall be subject to inspection by a supervisor, the Rangemaster or armorer at any time.
- (d) No modification shall be made to any shotgun without prior written authorization from the Chief of Police.

417.1.5 TRAINING

Officers shall not carry or utilize the shotgun unless they have successfully completed departmentally approved training. This training shall consist of an initial user's course and qualification with the department's Rangemaster. Officers shall thereafter be required to successfully complete regular training and qualification conducted by the department's Rangemaster.

Any officer who fails to qualify or who fails to successfully complete two or more department sanctioned training/qualification sessions will no longer be authorized to carry the shotgun without successfully retaking the initial shotgun user's course and qualification.

Culver City Police Department

Culver City PD Policy Manual

Shotgun

417.1.6 DEPLOYMENT OF THE SHOTGUN

Officers may deploy the shotgun in any circumstance where the officer can articulate a reasonable expectation that the shotgun may be needed. Examples of some general guidelines for deploying the shotgun may include, but are not limited to:

- (a) Situations where the officer reasonably anticipates an armed encounter
- (b) When an officer is faced with a situation that may require the delivery of accurate and effective fire and the suspect is beyond normal handgun range
- (c) Situations where an officer reasonably expects the need to meet or exceed a suspect's firepower
- (d) When an officer reasonably believes that there may be a need to deliver fire on a barricaded suspect
- (e) When authorized or requested by a supervisor

417.1.7 DISCHARGE OF THE SHOTGUN

The discharge of the shotgun shall be governed by the Department's Deadly Force Policy, Policy Manual § 300.

417.1.8 PATROL READY

Any qualified officer carrying a shotgun in the field shall maintain the weapon in a patrol ready condition until deployed. A shotgun is considered in a patrol ready condition when it has been inspected by the assigned officer, the safety is on "fire," the chamber is empty, it is secured and locked in a vehicle gun rack, the magazine tube is loaded with five buckshot shells, and the side saddle is loaded with six slug shells.

Officers working a special detail are not required to carry the shotgun in a vehicle gun rack, all other requirements of this section still apply to these officers.

417.1.9 SHOTGUN STORAGE

- (a) When not in use, shotguns will be stored in the department armory.
- (b) At the start of each assigned shift, any qualified, on-duty officer may contact the Desk Officer for access to the department armory.
- (c) A shotgun will only be removed from the armory for use after properly being checked out with the Desk Officer
- (d) At the end of the assigned officer's shift, the shotgun will be returned and secured in the department armory and checked in with the Desk Officer.

Field Training Officer Program

418.1 PURPOSE AND SCOPE

The Field Training Officer Program is intended to provide a standardized program to facilitate the officer's transition from the academic setting to the actual performance of general law enforcement duties of the Culver City Police Department.

It is the policy of this department to assign all new police officers to a structured Field Training Officer Program that is designed to prepare the new officer to perform in a patrol assignment, and possessing all skills needed to operate in a safe, productive, and professional manner.

418.2 FIELD TRAINING OFFICER - SELECTION AND TRAINING

The Field Training Officer (FTO) is an experienced officer trained in the art of supervising, training, and evaluating entry level and lateral police officers in the application of their previously acquired knowledge and skills.

418.2.1 SELECTION PROCESS

FTO's will be selected based on the following requirements:

- (a) Desire to be an FTO
- (b) Minimum of two years of patrol experience, all of which shall be with this department
- (c) Demonstrated ability as a positive role model
- (d) Evaluation by supervisors and current FTO's
- (e) Possess a POST Basic certificate

418.2.2 TRAINING

An officer selected as a Field Training Officer shall successfully complete a POST certified (40-hour) Field Training Officer's Course prior to being assigned as an FTO.

All FTOs must complete a 24-hour Field Training Officer update course every three years while assigned to the position of FTO (11 CCR 1004).

All FTOs must meet any training mandate regarding crisis intervention behavioral health training pursuant to Penal Code § 13515.28.

418.2.3 ASSIGNMENT

The Field Training Officer position is a six month assignment that can be modified at the discretion of the Bureau Commander or Chief of Police.

418.3 FIELD TRAINING OFFICER PROGRAM SUPERVISOR

The FTO Program supervisor should be selected from the rank of sergeant or above by the Operations Bureau Commander or a designee and should possess, or be eligible to receive, a POST Supervisory Certificate.

Culver City Police Department

Culver City PD Policy Manual

Field Training Officer Program

The responsibilities of the FTO Program supervisor include the following:

- (a) Assignment of trainees to FTOs
- (b) Conduct FTO meetings
- (c) Maintain and ensure FTO/trainee performance evaluations are completed
- (d) Maintain, update, and issue the Field Training Manual to each trainee
- (e) Monitor individual FTO performance
- (f) Monitor overall FTO Program
- (g) Maintain liaison with FTO coordinators of other agencies
- (h) Develop ongoing training for FTOs

The FTO Program supervisor will be required to successfully complete a POST-approved Field Training Administrator's Course within one year of appointment to this position (11 CCR 1004(c)).

418.4 TRAINEE DEFINED

Any entry level or lateral police officer newly appointed to the Culver City Police Department who has successfully completed a POST approved Basic Academy.

418.5 REQUIRED TRAINING

Entry level officers shall be required to successfully complete a POST-approved Field Training Program, consisting of a minimum of 10 weeks (Penal Code § 13515.295; 11 CCR 1004; 11 CCR 1005).

The training period for a lateral officer may be modified depending on the trainee's demonstrated performance and level of experience. A lateral officer may be exempt from the Field Training Program requirement if the officer qualifies for an exemption as provided in 11 CCR 1005(a)(B).

To the extent practicable, entry level and lateral officers should be assigned to a variety of Field Training Officers, shifts, and geographical areas during their Field Training Program.

418.5.1 FIELD TRAINING MANUAL

Each new officer will be given online access to a Field Training Manual at the beginning of his/her Primary Training Phase. This manual is an outline of the subject matter and/or skills necessary to properly function as an officer with the Culver City Police Department. The officer shall become knowledgeable of the subject matter as outlined. He/she shall also become proficient with those skills as set forth in the manual.

The Field Training Manual will specifically cover those policies, procedures, rules, and regulations adopted by the Culver City Police Department.

418.6 EVALUATIONS

Evaluations are an important component of the training process and shall be completed as outlined below.

Culver City Police Department

Culver City PD Policy Manual

Field Training Officer Program

418.6.1 FIELD TRAINING OFFICER

The FTO will be responsible for the following:

- (a) Complete and submit a written evaluation on the performance of his/her assigned trainee to the FTO Coordinator on a daily basis.
- (b) Review the Daily Trainee Performance Evaluations with the trainee each day.
- (c) Complete a detailed end-of-phase performance evaluation on his/her assigned trainee at the end of each phase of training.
- (d) Sign off all completed topics contained in the Field Training Manual, noting the method(s) of learning and evaluating the performance of his/her assigned trainee.

418.6.2 IMMEDIATE SUPERVISOR

The immediate supervisor shall review and approve the Daily Trainee Performance Evaluations and forward them to the Field Training Administrator.

418.6.3 FIELD TRAINING ADMINISTRATOR

The Field Training Administrator will review and approve the Daily Trainee Performance Evaluations submitted by the FTO through his/her immediate supervisor.

418.6.4 TRAINEE

At the completion of the Field Training Program, the trainee shall submit a confidential performance evaluation on each of their FTOs and on the Field Training Program.

418.7 DOCUMENTATION

All documentation of the Field Training Program will be retained in the officer's training files and will consist of the following:

- (a) Daily Trainee Performance Evaluations
- (b) End-of-phase evaluations
- (c) A Certificate of Completion certifying that the trainee has successfully completed the required number of hours of field training

Obtaining Air Support

419.1 PURPOSE AND SCOPE

The use of a police helicopter can be invaluable in certain situations. This policy specifies potential situations where the use of a helicopter may be requested and the responsibilities for making a request.

419.2 REQUEST FOR HELICOPTER ASSISTANCE

If a supervisor or officer in charge of an incident determines that the use of a helicopter would be beneficial, a request to obtain helicopter assistance may be made.

419.2.1 REQUEST FOR ASSISTANCE FROM ANOTHER AGENCY

After consideration and approval of the request for a helicopter, the Watch Commander, or his/her designee, will call the Los Angeles Police Department, Los Angeles County Sheriff's Department, or the closest agency with an available helicopter. The Watch Commander on duty or his/her designee will apprise that agency of the specific details of the incident prompting the request. When the helicopter arrives, the supervisor in charge of the incident, or his or her designee, will make contact with the helicopter crew by radio and provide them with all the relevant information needed to fulfill the objective.

419.2.2 CIRCUMSTANCES UNDER WHICH AID MAY BE REQUESTED

Police helicopters may be requested under any of the following conditions:

- (a) When the helicopter is activated under existing mutual aid agreements
- (b) Whenever the safety of law enforcement personnel is in jeopardy and the presence of the helicopters may reduce such hazard
- (c) When the use of the helicopters will aid in the capture of a suspected fleeing felon whose continued freedom represents an ongoing threat to the community
- (d) When a helicopter is needed to locate a person who has strayed or is lost and whose continued absence constitutes a serious health or safety hazard
- (e) Vehicle pursuits

While it is recognized that the availability of helicopter support will generally provide valuable assistance to ground personnel, the presence of a helicopter will rarely replace the need for officers on the ground.

Contacts and Temporary Detentions

420.1 PURPOSE AND SCOPE

The purpose of this policy is to establish guidelines for temporarily detaining but not arresting persons in the field, conducting field interviews (FI) and pat-down searches, and the taking and disposition of photographs.

420.1.1 CONSENSUAL ENCOUNTERS

Nothing in this policy is intended to discourage consensual contacts. Frequent and random casual contacts with consenting individuals are encouraged by the Culver City Police Department to strengthen our community involvement, community awareness and problem identification.

420.1.2 DEFINITIONS

Definitions related to this policy include:

Consensual encounter - When an officer contacts an individual but does not create a detention through words, actions, or other means. In other words, a reasonable individual would believe that his/her contact with the officer is voluntary.

Field interview - The brief detainment of an individual, whether on foot or in a vehicle, based on reasonable suspicion for the purpose of determining the individual's identity and resolving the officer's suspicions.

Field photographs - Posed photographs taken of a person during a contact, temporary detention, or arrest in the field. Undercover surveillance photographs of an individual and recordings captured by the normal operation of a Mobile Audio Video (MAV) system, body-worn camera, or public safety camera when persons are not posed for the purpose of photographing are not considered field photographs.

Pat-down search - A type of search used by officers in the field to check an individual for dangerous weapons. It involves a thorough patting-down of clothing to locate any weapons or dangerous items that could pose a danger to the officer, the detainee, or others.

Reasonable suspicion - When, under the totality of the circumstances, an officer has articulable facts that criminal activity may be afoot and a particular person is connected with that possible criminal activity.

Temporary detention - When an officer intentionally, through words, actions, or physical force, causes an individual to reasonably believe he/she is required to restrict his/her movement without an actual arrest. Temporary detentions also occur when an officer actually restrains a person's freedom of movement.

420.2 POLICY

The Culver City Police Department respects the right of the public to be free from unreasonable searches or seizures. Due to an unlimited variety of situations confronting the officer, the decision to temporarily detain a person and complete a field interview (FI), pat-down search, or field

Culver City Police Department

Culver City PD Policy Manual

Contacts and Temporary Detentions

photograph shall be left to the officer based on the totality of the circumstances, officer safety considerations, and constitutional safeguards.

420.3 FIELD INTERVIEWS

Based on observance of suspicious circumstances or upon information from investigation, an officer may initiate the stop of a person, and conduct an FI, when there is articulable, reasonable suspicion to do so. A person, however, shall not be detained longer than is reasonably necessary to resolve the officer's suspicion.

Nothing in this policy is intended to discourage consensual contacts. Frequent casual contact with consenting individuals is encouraged by the Culver City Police Department to strengthen community involvement, community awareness, and problem identification.

420.3.1 INITIATING A FIELD INTERVIEW

When initiating the stop, the officer should be able to point to specific facts which, when considered with the totality of the circumstances, reasonably warrant the stop. Such facts include but are not limited to an individual's:

- (a) Appearance or demeanor suggesting that he/she is part of a criminal enterprise or is engaged in a criminal act
- (b) Actions suggesting that he/she is engaged in a criminal activity
- (c) Presence in an area at an inappropriate hour of the day or night
- (d) Presence in a particular area is suspicious
- (e) Carrying of suspicious objects or items
- (f) Excessive clothes for the climate or clothes bulging in a manner that suggest he/she is carrying a dangerous weapon
- (g) Location in proximate time and place to an alleged crime
- (h) Physical description or clothing worn that matches a suspect in a recent crime
- (i) Prior criminal record or involvement in criminal activity as known by the officer

420.4 PAT-DOWN SEARCHES

Once a valid stop has been made, and consistent with the officer's training and experience, an officer may pat a suspect's outer clothing for weapons if the officer has a reasonable, articulable suspicion the suspect may pose a safety risk. The purpose of this limited search is not to discover evidence of a crime, but to allow the officer to pursue the investigation without fear of violence. Circumstances that may establish justification for performing a pat-down search include but are not limited to:

- (a) The type of crime suspected, particularly in crimes of violence where the use or threat of deadly weapons is involved.
- (b) Where more than one suspect must be handled by a single officer.
- (c) The hour of the day and the location or neighborhood where the stop takes place.

Culver City Police Department

Culver City PD Policy Manual

Contacts and Temporary Detentions

- (d) Prior knowledge of the suspect's use of force and/or propensity to carry weapons.
- (e) The actions and demeanor of the suspect.
- (f) Visual indications which suggest that the suspect is carrying a firearm or other weapon.

Whenever practicable, a pat-down search should not be conducted by a lone officer. A cover officer should be positioned to ensure safety and should not be involved in the search.

420.5 FIELD PHOTOGRAPHS

All available databases should be searched before photographing any field detainee. If a photograph is not located, or if an existing photograph no longer resembles the detainee, the officer shall carefully consider, among other things, the factors listed below.

420.5.1 FIELD PHOTOGRAPHS TAKEN WITH CONSENT

Field photographs may be taken when the subject being photographed knowingly and voluntarily gives consent. When taking a consensual photograph, the officer should have the individual read and sign the appropriate form accompanying the photograph.

420.5.2 FIELD PHOTOGRAPHS TAKEN WITHOUT CONSENT

Field photographs may be taken without consent only if they are taken during a detention that is based upon reasonable suspicion of criminal activity, and the photograph serves a legitimate law enforcement purpose related to the detention. The officer must be able to articulate facts that reasonably indicate that the subject was involved in or was about to become involved in criminal conduct. The subject should not be ordered to remove or lift any clothing for the purpose of taking a photograph.

If, prior to taking a photograph, the officer's reasonable suspicion of criminal activity has been dispelled, the detention must cease and the photograph should not be taken.

All field photographs and related reports shall be submitted to a supervisor and retained in compliance with this policy.

420.5.3 DISPOSITION OF PHOTOGRAPHS

All detainee photographs must be adequately labeled and uploaded into department records management software with associated documentation explaining the nature of the contact. If an individual is photographed as a suspect in a particular crime, the photograph should be submitted as an evidence item in the related case, following standard evidence procedures.

If a photograph is not associated with an investigation where a case number has been issued, the Watch Commander should review and forward the photograph to one of the following locations:

- (a) If the photograph and associated FI or documentation is relevant to criminal organization/enterprise enforcement, the Watch Commander will forward the photograph and documents to the designated criminal intelligence system supervisor. The supervisor will ensure the photograph and supporting documents are retained as prescribed in the Criminal Organizations Policy.

Culver City Police Department

Culver City PD Policy Manual

Contacts and Temporary Detentions

- (b) Photographs that do not qualify for retention in a criminal intelligence system or temporary information file shall be forwarded to the Records Section.

When a photograph is taken in association with a particular case, the investigator may use such photograph in a photo lineup. Thereafter, the individual photograph should be retained as a part of the case file. All other photographs shall be retained in accordance with the established records retention schedule.

420.5.4 SUPERVISOR RESPONSIBILITIES

While it is recognized that field photographs often become valuable investigative tools, supervisors should monitor such practices in view of the above listed considerations. This is not to imply that supervisor approval is required before each photograph is taken.

Access to, and use of, field photographs shall be strictly limited to law enforcement purposes.

420.6 WITNESS IDENTIFICATION AND INTERVIEWS

Because potential witnesses to an incident may become unavailable or the integrity of their statements compromised with the passage of time, officers should, when warranted by the seriousness of the case, take reasonable steps to promptly coordinate with an on-scene supervisor and/or criminal investigator to utilize available members for the following:

- (a) Identifying all persons present at the scene and in the immediate area.
 1. When feasible, a recorded statement should be obtained from those who claim not to have witnessed the incident but who were present at the time it occurred.
 2. Any potential witness who is unwilling or unable to remain available for a formal interview should not be detained absent reasonable suspicion to detain or probable cause to arrest. Without detaining the individual for the sole purpose of identification, officers should attempt to identify the witness prior to his/her departure.
- (b) Witnesses who are willing to provide a formal interview should be asked to meet at a suitable location where criminal investigators may obtain a recorded statement. Such witnesses, if willing, may be transported by Culver City Police Department members.
 1. A written, verbal, or recorded statement of consent should be obtained prior to transporting a witness. When the witness is a minor, consent should be obtained from the parent or guardian, if available, prior to transport.

Criminal Organizations

421.1 PURPOSE AND SCOPE

The purpose of this policy is to ensure that the Culver City Police Department appropriately utilizes criminal intelligence systems and temporary information files to support investigations of criminal organizations and enterprises.

421.1.1 DEFINITIONS

Definitions related to this policy include:

Criminal intelligence system - Any record system that receives, stores, exchanges or disseminates information that has been evaluated and determined to be relevant to the identification of a criminal organization or enterprise, its members or affiliates. This does not include temporary information files.

421.2 POLICY

The Culver City Police Department recognizes that certain criminal activities, including but not limited to gang crimes and drug trafficking, often involve some degree of regular coordination and may involve a large number of participants over a broad geographical area.

It is the policy of this department to collect and share relevant information while respecting the privacy and legal rights of the public.

421.3 CRIMINAL INTELLIGENCE SYSTEMS

No department member may create, submit to or obtain information from a criminal intelligence system unless the Chief of Police has approved the system for department use.

Any criminal intelligence system approved for department use should meet or exceed the standards of 28 CFR 23.20.

A designated supervisor will be responsible for maintaining each criminal intelligence system that has been approved for department use. The supervisor or the authorized designee should ensure the following:

- (a) Members using any such system are appropriately selected and trained.
- (b) Use of every criminal intelligence system is appropriately reviewed and audited.
- (c) Any system security issues are reasonably addressed.

421.3.1 SYSTEM ENTRIES

It is the designated supervisor's responsibility to approve the entry of any information from a report, field interview (FI), photo or other relevant document into an authorized criminal intelligence system. If entries are made based upon information that is not on file with this department, such as open or public source documents or documents that are on file at another agency, the designated supervisor should ensure copies of those documents are retained by the Records Section. Any supporting documentation for an entry shall be retained by the Records Section in accordance

Culver City Police Department

Culver City PD Policy Manual

Criminal Organizations

with the established records retention schedule and for at least as long as the entry is maintained in the system.

The designated supervisor should ensure that any documents retained by the Records Section are appropriately marked as intelligence information. The Records Supervisor may not purge such documents without the approval of the designated supervisor.

421.3.2 GANG DATABASES

The Chief of Police may approve participation by the gang unit in a shared criminal gang intelligence database, such as CALGANG®. Members must obtain the requisite training before accessing any such database (11 CCR 751.6).

It is the gang unit supervisor's responsibility to determine whether any report or FI contains information that would qualify for entry into the database. Prior to designating any person as a suspected gang member, associate, or affiliate in a shared gang database; or submitting a document to the Attorney General's office for the purpose of designating a person in a shared gang database; or otherwise identifying the person in a shared gang database, the gang unit supervisor shall provide written notice to the person and, if the person is under the age of 18, to his/her parent or guardian of the designation and the basis for the designation, unless providing that notification would compromise an active criminal investigation or compromise the health or safety of a minor. Notice shall also describe the process to contest the designation (Penal Code § 186.34).

The person, an attorney working on his/her behalf, or his/her parent or guardian (if the person is under 18 years of age) may request, in writing, information as to whether the person is designated as a suspected gang member, associate, or affiliate in a shared gang database accessible by the Department, the basis for that designation, and the name of the agency that made the designation. The Department shall respond to a valid request in writing within 30 days, and shall provide the information requested unless doing so would compromise an active investigation or compromise the health and safety of the person if he/she is under 18 years of age (Penal Code § 186.34).

The person, or his/her parent or guardian if the person is under 18 years of age, may contest the designation by submitting written documentation, which shall be reviewed by the gang unit supervisor. If it is determined that the person is not a suspected gang member, associate, or affiliate, the person shall be removed from the database. The person and the parent or guardian shall be provided written verification of the department's decision within 30 days of receipt of the written documentation contesting the designation and shall include the reason for a denial when applicable (Penal Code § 186.34).

The gang unit supervisor should forward reports or FIs to the Records Section after appropriate database entries are made. The supervisor should clearly mark the report/FI as gang intelligence information.

It is the responsibility of the Records Section supervisor to retain reports and FIs in compliance with the database rules and any applicable end user agreement.

Culver City Police Department

Culver City PD Policy Manual

Criminal Organizations

Records contained in a shared gang database shall not be disclosed for employment or military screening purposes, and shall not be disclosed for the purpose of enforcing federal immigration law unless required by state or federal statute or regulation (Penal Code § 186.36).

421.4 TEMPORARY INFORMATION FILE

No member may create or keep files on individuals that are separate from the approved criminal intelligence system. However, members may maintain temporary information that is necessary to actively investigate whether a person or group qualifies for entry into the department-approved criminal intelligence system only as provided in this section. Once information qualifies for inclusion, it should be submitted to the supervisor responsible for consideration of criminal intelligence system entries.

421.4.1 FILE REVIEW AND PURGING

The contents of a temporary information file shall not be retained longer than one year. At the end of one year, the contents must be purged.

The designated supervisor shall periodically review the temporary information files to verify that the contents meet the criteria for retention. Validation and purging of files is the responsibility of the supervisor.

421.5 INFORMATION RECOGNITION

Department members should document facts that suggest an individual, organization or enterprise is involved in criminal activity and should forward that information appropriately. Examples include, but are not limited to:

- (a) Gang indicia associated with a person or residence.
- (b) Information related to a drug-trafficking operation.
- (c) Vandalism indicating an animus for a particular group.
- (d) Information related to an illegal gambling operation.

Department supervisors who utilize an authorized criminal intelligence system should work with the Personnel and Training Lieutenant to train members to identify information that may be particularly relevant for inclusion.

421.6 RELEASE OF INFORMATION

Department members shall comply with the rules of an authorized criminal intelligence system regarding inquiries and release of information.

Information from a temporary information file may only be furnished to department members and other law enforcement agencies on a need-to-know basis and consistent with the Records Maintenance and Release Policy.

When an inquiry is made by the parent or guardian of a juvenile as to whether that juvenile's name is in a temporary information file, such information should be provided by the supervisor

Culver City Police Department

Culver City PD Policy Manual

Criminal Organizations

responsible for the temporary information file, unless there is good cause to believe that the release of such information might jeopardize an ongoing criminal investigation.

421.7 CRIMINAL STREET GANGS

The Detective Bureau supervisor should ensure that there are an appropriate number of department members who can:

- (a) Testify as experts on matters related to criminal street gangs, and maintain an above average familiarity with:
 - 1. Any organization, associate or group of three or more persons that meets the definition of a criminal street gang under Penal Code § 186.22(f).
 - 2. Identification of a person as a criminal street gang member and criminal street gang-related crimes.
 - 3. The California Street Terrorism Enforcement and Prevention Act (Penal Code § 186.21 et seq.), associated crimes and what defines a criminal street gang (Penal Code § 186.22).
- (b) Coordinate with other agencies in the region regarding criminal street gang-related crimes and information.
- (c) Train other members to identify gang indicia and investigate criminal street gang-related crimes.

421.8 TRAINING

The Personnel and Training Lieutenant should provide training on best practices in the use of each authorized criminal intelligence system to those tasked with investigating criminal organizations and enterprises. Training should include:

- (a) The protection of civil liberties.
- (b) Participation in a multiagency criminal intelligence system.
- (c) Submission of information into a multiagency criminal intelligence system or the receipt of information from such a system, including any governing federal and state rules and statutes.
- (d) The type of information appropriate for entry into a criminal intelligence system or temporary information file.
- (e) The review and purging of temporary information files.

421.8.1 SHARED GANG DATABASE TRAINING

The Personnel and Training Lieutenant should ensure that members who are authorized users of a shared gang database receive the required training from the California Department of Justice (DOJ) or an instructor certified by the DOJ that includes comprehensive and standardized

Culver City Police Department

Culver City PD Policy Manual

Criminal Organizations

training on the use of shared gang databases, and any other associated training required by the Department (Penal Code § 186.36; 11 CCR 751.6).

Watch Commanders

422.1 PURPOSE AND SCOPE

Each patrol shift must be directed by supervisors who are capable of making decisions and communicating in a manner consistent with departmental policies, procedures, practices, functions and objectives. To accomplish this goal, a Lieutenant heads each watch.

422.2 DESIGNATION AS ACTING WATCH COMMANDER

When a Lieutenant is unavailable for duty as Watch Commander, a sergeant shall be designated as the Watch Commander. This policy does not preclude designating a less senior sergeant as an acting Watch Commander when operational needs require or training permits.

Mobile Digital Computer Use

423.1 PURPOSE AND SCOPE

The purpose of this policy is to establish guidelines for the proper access, use and application of the Mobile Digital Computer (MDC) system in order to ensure appropriate access to confidential records from local, state and national law enforcement databases, and to ensure effective electronic communications between department members and Southbay RCC.

423.2 PRIVACY EXPECTATION

Members forfeit any expectation of privacy with regard to messages accessed, transmitted, received or reviewed on any department technology system (see the Information Technology Use Policy for additional guidance).

423.3 POLICY

Culver City Police Department members using the MDC shall comply with all appropriate federal and state rules and regulations and shall use the MDC in a professional manner, in accordance with this policy.

423.4 RESTRICTED ACCESS AND USE

MDC use is subject to the Information Technology Use and Protected Information policies.

Members shall not access the MDC system if they have not received prior authorization and the required training. Members shall immediately report unauthorized access or use of the MDC by another member to their supervisors or Watch Commanders.

Use of the MDC system to access law enforcement databases or transmit messages is restricted to official activities, business-related tasks and communications that are directly related to the business, administration or practices of the Department. In the event that a member has questions about sending a particular message or accessing a particular database, the member should seek prior approval from his/her supervisor.

Sending derogatory, defamatory, obscene, disrespectful, sexually suggestive, harassing or any other inappropriate messages on the MDC system is prohibited and may result in discipline.

It is a violation of this policy to transmit a message or access a law enforcement database under another member's name or to use the password of another member to log in to the MDC system unless directed to do so by a supervisor. Members are required to log off the MDC or secure the MDC when it is unattended. This added security measure will minimize the potential for unauthorized access or misuse.

423.4.1 USE WHILE DRIVING

Use of the MDC by the vehicle operator should be limited to times when the vehicle is stopped. Information that is required for immediate enforcement, investigative, tactical or safety needs should be transmitted over the radio.

Culver City Police Department

Culver City PD Policy Manual

Mobile Digital Computer Use

Short transmissions, such as a license plate check, are permitted if it reasonably appears that it can be done safely. In no case shall an operator attempt to send or review lengthy messages while the vehicle is in motion.

423.5 DOCUMENTATION OF ACTIVITY

Except as otherwise directed by the Watch Commander or other department-established protocol, all calls for service assigned by a dispatcher should be communicated by voice over the police radio and electronically via the MDC unless security or confidentiality prevents such broadcasting.

MDC and voice transmissions are used to document the member's daily activity. To ensure accuracy:

- (a) All contacts or activity should be documented at the time of the contact.
- (b) Whenever the activity or contact is initiated by voice, it should be documented by a dispatcher.
- (c) Whenever the activity or contact is not initiated by voice, the member should document it via the MDC.

423.5.1 STATUS CHANGES

All changes in status (e.g., arrival at scene, meal periods, in service) will be transmitted over the police radio or through the MDC system.

Members responding to in-progress calls should advise changes in status over the radio to assist other members responding to the same incident. Other changes in status can be made on the MDC.

423.5.2 EMERGENCY ACTIVATION

If there is an emergency activation and the member does not respond to a request for confirmation of the need for emergency assistance or confirms the need, available resources will be sent to assist in locating the member. If the location is known, the nearest available officer should respond in accordance with the Officer Response to Calls Policy.

Members should ensure a field supervisor and the Watch Commander are notified of the incident without delay.

Officers not responding to the emergency shall refrain from transmitting on the police radio until a no-further-assistance broadcast is made or if they are also handling an emergency.

423.6 EQUIPMENT CONSIDERATIONS

423.6.1 MALFUNCTIONING MDC

Whenever possible, members will not use vehicles with malfunctioning MDCs. Whenever members must drive a vehicle in which the MDC is not working, they shall notify Southbay RCC. It shall be the responsibility of the dispatcher to document all information that will then be transmitted verbally over the police radio.

Culver City Police Department

Culver City PD Policy Manual

Mobile Digital Computer Use

423.6.2 BOMB CALLS

When investigating reports of possible bombs, members should not communicate on their MDCs when in the evacuation area of a suspected explosive device. Radio frequency emitted by the MDC could cause some devices to detonate.

Portable Audio/Video Recorders

424.1 PURPOSE AND SCOPE

This policy provides guidelines for the use of portable audio/video recording devices by members of this department while in the performance of their duties. Portable audio/video recording devices include all recording systems whether body-worn, hand held or integrated into portable equipment.

This policy does not apply to mobile audio/video recordings, interviews or interrogations conducted at any Culver City Police Department facility, authorized undercover operations, wiretaps or eavesdropping (concealed listening devices).

424.2 POLICY

The Culver City Police Department may provide members with access to portable recorders, either audio or video or both, for use during the performance of their duties. The use of recorders is intended to enhance the mission of the Department by accurately capturing contacts between members of the Department and the public.

424.3 MEMBER PRIVACY EXPECTATION

All recordings made by members on any department-issued device at any time, and any recording made while acting in an official capacity for this department, regardless of ownership of the device it was made on, shall remain the property of the Department. Members shall have no expectation of privacy or ownership interest in the content of these recordings.

424.3.1 NON-CRIMINAL MATTER

At any time that an officer reasonably believes that a recorded contact may be of benefit in a non-criminal matter (e.g., a hostile contact), the recorded media shall be forwarded to the Professional Standards Unit via the chain of command.

(a) Under such circumstances, the officer shall notify a supervisor of the existence of the recording as soon as practicable.

(b) Recorded media which has been forwarded to PSU shall be retained for a period of no less than 2 years or until the related matter has been closed (e.g., internal investigation, civil litigation).

424.4 MEMBER RESPONSIBILITIES

Any sworn member of the department may carry an approved portable recorder at any time during the course of their duties when the member believes that such a device may be useful. Unless conducting a lawful recording in an authorized undercover capacity, non-uniformed members should notify persons that they are being recorded, whenever reasonably practicable.

When using a portable recorder, the assigned member should record his/her name, CCPD identification number and the current date and time at the beginning and the end of the shift or other period of use, regardless of whether any activity was recorded. This procedure is not required when the recording device and related software captures the user's unique identification and the date and time of each recording.

Culver City Police Department

Culver City PD Policy Manual

Portable Audio/Video Recorders

Members should document the existence of a recording in any report or other official record of the contact, including any instance where the recorder malfunctioned or the member deactivated the recording. Members should include the reason for deactivation.

424.5 RETENTION OF RECORDINGS

Recordings of the following should be retained for a minimum of two years (Penal Code § 832.18):

- (a) Incidents involving use of force by an officer
- (b) Officer-involved shootings
- (c) Incidents that lead to the detention or arrest of an individual
- (d) Recordings relevant to a formal or informal complaint against an officer or the Culver City Police Department

Recordings containing evidence that may be relevant to a criminal prosecution should be retained for any additional period required by law for other evidence relevant to a criminal prosecution (Penal Code § 832.18).

All other recordings should be retained for a period consistent with the requirements of the organization's records retention schedule but in no event for a period less than 180 days.

Records or logs of access and deletion of recordings should be retained permanently (Penal Code § 832.18).

424.5.1 RELEASE OF AUDIO RECORDINGS

Requests for the release of audio/video recordings shall be processed in accordance with the Records Maintenance and Release Policy.

Medical Marijuana

425.1 PURPOSE AND SCOPE

The purpose of this policy is to provide members of this Department with guidelines for investigating the acquisition, possession, transportation, delivery, production or use of marijuana under California's medical marijuana laws.

425.1.1 DEFINITIONS

Definitions related to this policy include:

Cardholder - A person issued a current identification card.

Compassionate Use Act (CUA) (Health and Safety Code § 11362.5) - California law intended to provide protection from prosecution to those who are seriously ill and whose health would benefit from the use of marijuana in the treatment of illness for which marijuana provides relief. The CUA does not grant immunity from arrest but rather provides an affirmative defense from prosecution for possession of medical marijuana.

Identification card - A valid document issued by the California Department of Public Health to both persons authorized to engage in the medical use of marijuana and also to designated primary caregivers.

Medical marijuana - Marijuana possessed by a patient or primary caregiver for legitimate medical purposes.

Medical Marijuana Program (MMP) (Health and Safety Code § 11362.7 et seq.) - California laws passed following the CUA to facilitate the prompt identification of patients and their designated primary caregivers in order to avoid unnecessary arrests and provide needed guidance to law enforcement officers. MMP prohibits arrest for possession of medical marijuana in certain circumstances and provides a defense in others.

Patient - A person who is entitled to the protections of the CUA because he/she has received a written or oral recommendation or approval from a physician to use marijuana for medical purposes or any person issued a valid identification card.

Primary caregiver - A person designated by the patient, who has consistently assumed responsibility for the patient's housing, health or safety, who may assist the patient with the medical use of marijuana under the CUA or the MMP (Health and Safety Code § 11362.5; Health and Safety Code § 11362.7).

Statutory amount - No more than 8 ounces of dried, mature, processed female marijuana flowers ("bud") or the plant conversion (e.g., kief, hash, hash oil), and no more than six mature or 12 immature marijuana plants (roots, stems and stem fibers should not be considered) (Health and Safety Code § 11362.77).

Culver City Police Department

Culver City PD Policy Manual

Medical Marijuana

425.2 POLICY

It is the policy of the Culver City Police Department to prioritize resources to forgo making arrests related to marijuana that the arresting officer reasonably believes would not be prosecuted by state or federal authorities.

California's medical marijuana laws are intended to provide protection to those who are seriously ill and whose health would benefit from the use of medical marijuana.

However, California medical marijuana laws do not affect federal laws and there is no medical exception under federal law for the possession or distribution of marijuana. The Culver City Police Department will exercise discretion to ensure laws are appropriately enforced without unreasonably burdening both those individuals protected under California law and public resources.

425.3 INVESTIGATION

Investigations involving the possession, delivery, production or use of marijuana generally fall into one of several categories:

- (a) Investigations when no person makes a medicinal claim.
- (b) Investigations when a medicinal claim is made by a cardholder.
- (c) Investigations when a medicinal claim is made by a non-cardholder.

425.3.1 INVESTIGATIONS WITH NO MEDICINAL CLAIM

In any investigation involving the possession, delivery, production or use of marijuana or drug paraphernalia where no person claims that the marijuana is used for medicinal purposes, the officer should proceed with a criminal investigation if the amount is greater than permitted for personal use under the Control, Regulate and Tax Adult Use of Marijuana Act (Health and Safety Code § 11362.1; Health and Safety Code § 11362.2). A medicinal defense may be raised at any time, so officers should document any statements and observations that may be relevant to whether the marijuana was possessed or produced for medicinal purposes.

425.3.2 INVESTIGATIONS INVOLVING A MEDICINAL CLAIM MADE BY A CARDHOLDER

A cardholder or designated primary caregiver in possession of an identification card shall not be arrested for possession, transportation, delivery or cultivation of medical marijuana at or below the statutory amount unless there is probable cause to believe that (Health and Safety Code § 11362.71; Health and Safety Code § 11362.78):

- (a) The information contained in the card is false or falsified.
- (b) The card has been obtained or used by means of fraud.
- (c) The person is otherwise in violation of the provisions of the MMP.
- (d) The person possesses marijuana but not for personal medical purposes.

Culver City Police Department

Culver City PD Policy Manual

Medical Marijuana

Officers who reasonably believe that a person who does not have an identification card in his/her possession has been issued an identification card may treat the investigation as if the person had the card in his/her possession.

Cardholders may possess, transport, deliver or cultivate medical marijuana in amounts above the statutory amount if their doctor has concluded that the statutory amount does not meet the patient's medical needs (Health and Safety Code § 11362.71; Health and Safety Code § 11362.77). Investigations involving cardholders with more than the statutory amount of marijuana should be addressed as provided in this policy for a case involving a medicinal claim made by a non-cardholder.

425.3.3 INVESTIGATIONS INVOLVING A MEDICINAL CLAIM MADE BY A NON-CARDHOLDER

No patient or primary caregiver should be arrested for possession or cultivation of an amount of medical marijuana if the officer reasonably believes that marijuana is in a form and amount reasonably related to the qualified patient's current medical needs (Health and Safety Code § 11362.5). This arrest guidance also applies to sales, transportation or delivery of medical marijuana, or maintaining/renting a drug house or building that may be a nuisance if otherwise in compliance with MMP (Health and Safety Code § 11362.765).

Officers are not obligated to accept a person's claim of having a physician's recommendation when the claim cannot be readily verified with the physician but are expected to use their judgment to assess the validity of the person's medical-use claim.

Officers should review any available written documentation for validity and whether it contains the recommending physician's name, telephone number, address and medical license number for verification.

Officers should generally accept verified recommendations by a physician that statutory amounts do not meet the patient's needs (Health and Safety Code § 11362.77).

425.3.4 ADDITIONAL CONSIDERATIONS

Officers should consider the following when investigating an incident involving marijuana possession, delivery, production, or use:

- (a) Because enforcement of medical marijuana laws can be complex, time consuming, and call for resources unavailable at the time of initial investigation, officers may consider submitting a report to the prosecutor for review, in lieu of making an arrest. This can be particularly appropriate when:
 1. The suspect has been identified and can be easily located at a later time.
 2. The case would benefit from review by a person with expertise in medical marijuana investigations.
 3. Sufficient evidence, such as photographs or samples, has been lawfully obtained.

Culver City Police Department

Culver City PD Policy Manual

Medical Marijuana

4. Other relevant factors, such as available department resources and time constraints prohibit making an immediate arrest.
- (b) Whenever the initial investigation reveals an amount of marijuana greater than the statutory amount, officers should consider the following when determining whether the form and amount is reasonably related to the patient's needs:
1. The amount of marijuana recommended by a medical professional to be ingested.
 2. The quality of the marijuana.
 3. The method of ingestion (e.g., smoking, eating, nebulizer).
 4. The timing of the possession in relation to a harvest (patient may be storing marijuana).
 5. Whether the marijuana is being cultivated indoors or outdoors.
- (c) Before proceeding with enforcement related to collective gardens or dispensaries, officers should consider conferring with a supervisor, an applicable state regulatory agency or other member with special knowledge in this area, and/or appropriate legal counsel (Business and Professions Code § 26010; Business and Professions Code § 26060). Licensing, zoning, and other related issues can be complex. Patients, primary caregivers, and cardholders who collectively or cooperatively cultivate marijuana for medical purposes may be licensed or may have a defense in certain circumstances (Business and Professions Code § 26032; Business and Professions Code § 26033).
- (d) Investigating members should not order a patient to destroy marijuana plants under threat of arrest.

425.3.5 EXCEPTIONS

This policy does not apply to, and officers should consider taking enforcement action for the following:

- (a) Persons who engage in illegal conduct that endangers others, such as driving under the influence of marijuana in violation of the Vehicle Code (Health and Safety Code § 11362.5).
- (b) Marijuana possession in jails or other correctional facilities that prohibit such possession (Health and Safety Code § 11362.785).
- (c) Smoking marijuana (Health and Safety Code § 11362.79):
 1. In any place where smoking is prohibited by law.
 2. In or within 1,000 feet of the grounds of a school, recreation center or youth center, unless the medical use occurs within a residence.
 3. On a school bus.
 4. While in a motor vehicle that is being operated.
 5. While operating a boat.

Culver City Police Department

Culver City PD Policy Manual

Medical Marijuana

- (d) Use of marijuana by a person on probation or parole, or on bail and use is prohibited by the terms of release (Health and Safety Code § 11362.795).

425.3.6 INVESTIGATIONS INVOLVING A STATE LICENSEE

No person issued a state license under the Business and Professions Code shall be arrested or cited for cultivation, possession, manufacture, processing, storing, laboratory testing, labeling, transporting, distribution or sale of medical cannabis or a medical cannabis product related to qualifying patients and primary caregivers when conducted lawfully. Whether conduct is lawful may involve questions of license classifications, local ordinances, specific requirements of the Business and Professions Code and adopted regulations. Officers should consider conferring with a supervisor, the applicable state agency or other member with special knowledge in this area and/or appropriate legal counsel before taking enforcement action against a licensee or an employee or agent (Business and Professions Code § 26032).

425.4 FEDERAL LAW ENFORCEMENT

Officers should provide information regarding a marijuana investigation to federal law enforcement authorities when it is requested by federal law enforcement authorities or whenever the officer believes those authorities would have a particular interest in the information.

425.5 PROPERTY AND EVIDENCE SECTION SUPERVISOR RESPONSIBILITIES

The Property and Evidence Section supervisor should ensure that marijuana, drug paraphernalia or other related property seized from a person engaged or assisting in the use of medical marijuana is not destroyed pending any charges and without a court order. The Property and Evidence Section supervisor is not responsible for caring for live marijuana plants.

Upon the prosecutor's decision to forgo prosecution, or the dismissal of charges or an acquittal, the Property and Evidence Section supervisor should, as soon as practicable, return to the person from whom it was seized any useable medical marijuana, plants, drug paraphernalia or other related property.

The Property and Evidence Section supervisor may release marijuana to federal law enforcement authorities upon presentation of a valid court order or by a written order of the Detective Bureau supervisor.

Bicycle Patrol Unit

426.1 PURPOSE AND SCOPE

The Culver City Police Department has established the Special Enforcement Team (S.E.T.) for the purpose of enhancing patrol efforts in the community. Bicycle patrol has been shown to be an effective way to increase officer visibility and their quiet operation can provide a tactical approach to crimes in progress. The purpose of this policy is to provide guidelines for the safe and effective operation of the patrol bicycle.

426.2 POLICY

Bicycles may be deployed to any area at all hours of the day or night, according to Department needs.

Requests for specific deployment of bicycle patrol officers shall be coordinated through the Operations Bureau Commander or the S.E.T. Supervisor.

426.3 TRAINING

Participants in the program must complete a Department approved bicycle-training course before being assigned a bicycle patrol detail. Thereafter bicycle patrol officers should receive training as needed to maintain skills and refresh safety, health and operational procedures, or at the direction of the S.E.T. Sergeant. The training shall minimally include the following:

- Bicycle patrol strategies.
- Bicycle safety and accident prevention.
- Operational tactics using bicycles.

If assigned to a detail in which an officer rides a bicycle, he/she may be required to qualify with their duty firearm while wearing bicycle safety equipment including the helmet and riding gloves.

426.4 UNIFORMS AND EQUIPMENT

Officers should wear the department-approved uniform and safety equipment while operating the department bicycle. Safety equipment includes department-approved helmet, riding gloves, protective eyewear and black athletic shoes without a contrasting manufacturer's logo.

The bicycle patrol unit uniform consists of the standard short or long sleeve (Crime Impact Team) POLICE polo shirt, and black bicycle patrol pants or shorts.

Helmets will be made available by the department, or, at their own expense, Officers may purchase their own helmet for use while assigned to bicycle patrol duties. This helmet will be similar to the helmets maintained by the department and shall be black in color with 1/2" block capital lettering on each side reading "POLICE." Helmets will be available through an approved department vendor. Officers should obtain approval from the S.E.T. Sergeant prior to ordering a helmet for use while on duty.

Culver City Police Department

Culver City PD Policy Manual

Bicycle Patrol Unit

Optional equipment includes a radio head set and microphone, and jackets in colder weather. Turtleneck shirts are permitted only when a long-sleeved uniform shirt is worn.

Bicycle patrol officers shall carry the same equipment on the bicycle patrol duty belt as they would on a regular patrol assignment.

Officers will be responsible for obtaining the necessary forms, citation books and other department equipment needed while on bicycle patrol.

426.5 CARE AND USE OF PATROL BICYCLES

Officers participating in bicycle patrol details will use a department-owned, specially marked and equipped patrol bicycle. If needed, the bicycle may be equipped with an attached gear bag.

Bicycles utilized for uniformed bicycle patrol shall be primarily black or white with a "POLICE" decal affixed to each side of the crossbar and the bike's saddlebag. Every such bicycle shall be equipped with front and rear reflectors front lights and a siren/horn satisfying the requirements of Vehicle Code §2800.1(b).

Bicycles utilized for uniformed bicycle patrol may be equipped with a rear rack and/or saddle bag(s) sufficient to carry all necessary equipment to handle the assigned detail.

Each bicycle may be equipped with a steady or flashing blue warning light that is visible from the front, sides, or rear of the bicycle. (Vehicle Code § 21201.3)

S.E.T. officers shall conduct an inspection of the bicycle and equipment prior to use to insure proper working order of the equipment. Officers are responsible for the routine care and maintenance of their assigned equipment (e.g., tire pressure, chain lubrication, overall cleaning).

If a needed repair is beyond the ability of the bicycle officer, the officer will notify the S.E.T. Sergeant. The S.E.T. Sergeant will be responsible for arranging maintenance and repairs on the department bicycles at a department approved repair shop.

At the end of a bicycle assignment, the bicycle shall be returned clean and in good working order for the next assignment.

Officers shall not modify the patrol bicycle, remove, modify or add components except with the approval of the S.E.T. Sergeant, or in the event of an emergency.

Vehicle bicycle racks are available should the officer need to transport the patrol bicycle. Due to possible component damage, transportation of the patrol bicycle in a trunk or on a patrol car push-bumper is discouraged.

Bicycles should be properly secured when not in the officer's immediate presence.

426.6 OFFICER RESPONSIBILITY

Officers shall operate the bicycle in compliance with the vehicle code under normal operation. Officers may operate the bicycle without lighting equipment during hours of darkness when such operation reasonably appears necessary for officer safety and tactical considerations. Officers must use caution and care when operating the bicycle without lighting equipment.

Foot Pursuits

427.1 PURPOSE AND SCOPE

This policy provides guidelines to assist officers in making the decision to initiate or continue the pursuit of suspects on foot.

427.1.1 POLICY

It is the policy of this department when deciding to initiate or continue a foot pursuit that officers must continuously balance the objective of apprehending the suspect with the risk and potential for injury to department personnel, the public or the suspect.

Officers are expected to act reasonably, based on the totality of the circumstances. The safety of department personnel and the public should be the primary consideration when determining whether a foot pursuit should be initiated or continued. Officers must be mindful that immediate apprehension of a suspect is not always more important than the safety of the public and department personnel.

427.2 DECISION TO PURSUE

The safety of department members and the public should be the primary consideration when determining whether a foot pursuit should be initiated or continued. Officers must be mindful that immediate apprehension of a suspect is rarely more important than the safety of the public and department members.

Officers may be justified in initiating a foot pursuit of any individual the officer reasonably believes is about to engage in, is engaging in or has engaged in criminal activity. The decision to initiate or continue such a foot pursuit, however, must be continuously re-evaluated in light of the circumstances presented at the time.

Mere flight by a person who is not suspected of criminal activity shall not serve as justification for engaging in an extended foot pursuit without the development of reasonable suspicion regarding the individual's involvement in criminal activity or being wanted by law enforcement.

Deciding to initiate or continue a foot pursuit is a decision that an officer must make quickly and under unpredictable and dynamic circumstances. It is recognized that foot pursuits may place department members and the public at significant risk. Therefore, no officer or supervisor shall be criticized or disciplined for deciding not to engage in a foot pursuit because of the perceived risk involved.

If circumstances permit, surveillance and containment are generally the safest tactics for apprehending fleeing persons. In deciding whether to initiate or continue a foot pursuit, an officer should continuously consider reasonable alternatives to a foot pursuit based upon the circumstances and resources available, such as:

- (a) Containment of the area.

Culver City Police Department

Culver City PD Policy Manual

Foot Pursuits

- (b) Saturation of the area with law enforcement personnel, including assistance from other agencies.
- (c) A canine search.
- (d) Thermal imaging or other sensing technology.
- (e) Air support.
- (f) Apprehension at another time when the identity of the suspect is known or there is information available that would likely allow for later apprehension, and the need to immediately apprehend the suspect does not reasonably appear to outweigh the risk of continuing the foot pursuit.

427.3 GENERAL GUIDELINES

When reasonably practicable, officers should consider alternatives to engaging in or continuing a foot pursuit when:

- (a) Directed by a supervisor to terminate the foot pursuit; such an order shall be considered mandatory
- (b) The officer is acting alone.
- (c) Two or more officers become separated, lose visual contact with one another, or obstacles separate them to the degree that they cannot immediately assist each other should a confrontation take place. In such circumstances, it is generally recommended that a single officer keep the suspect in sight from a safe distance and coordinate the containment effort.
- (d) The officer is unsure of his/her location and direction of travel.
- (e) The officer is pursuing multiple suspects and it is not reasonable to believe that the officer would be able to control the suspect should a confrontation occur.
- (f) The physical condition of the officer renders him/her incapable of controlling the suspect if apprehended.
- (g) The officer loses radio contact with the dispatcher or with assisting or backup officers.
- (h) The suspect enters a building, structure, confined space, isolated area or dense or difficult terrain, and there are insufficient officers to provide backup and containment. The primary officer should consider discontinuing the foot pursuit and coordinating containment pending the arrival of sufficient resources.
- (i) The officer becomes aware of unanticipated or unforeseen circumstances that unreasonably increase the risk to officers or the public.
- (j) The officer reasonably believes that the danger to the pursuing officers or public outweighs the objective of immediate apprehension.
- (k) The officer loses possession of his/her firearm or other essential equipment.

Culver City Police Department

Culver City PD Policy Manual

Foot Pursuits

- (l) The officer or a third party is injured during the pursuit, requiring immediate assistance, and there are no other emergency personnel available to render assistance.
- (m) The suspect's location is no longer definitely known.
- (n) The identity of the suspect is established or other information exists that will allow for the suspect's apprehension at a later time, and it reasonably appears that there is no immediate threat to department members or the public if the suspect is not immediately apprehended.
- (o) The officer's ability to safely continue the pursuit is impaired by inclement weather, darkness or other environmental conditions.

427.4 RESPONSIBILITIES IN FOOT PURSUITS

427.4.1 INITIATING OFFICER RESPONSIBILITIES

Unless relieved by another officer or a supervisor, the initiating officer shall be responsible for coordinating the progress of the pursuit. When acting alone and when practicable, the initiating officer should not attempt to overtake and confront the suspect but should attempt to keep the suspect in sight until sufficient officers are present to safely apprehend the suspect.

Early communication of available information from the involved officers is essential so that adequate resources can be coordinated and deployed to bring a foot pursuit to a safe conclusion. Officers initiating a foot pursuit should, at a minimum, broadcast the following information as soon as it becomes practicable and available:

- (a) Location and direction of travel
- (b) Call sign identifier
- (c) Reason for the foot pursuit, such as the crime classification
- (d) Number of suspects and description, to include name if known
- (e) Whether the suspect is known or believed to be armed with a dangerous weapon

Officers should be mindful that radio transmissions made while running may be difficult to understand and may need to be repeated.

Absent extenuating circumstances, any officer unable to promptly and effectively broadcast this information should terminate the foot pursuit. If the foot pursuit is discontinued for any reason, immediate efforts for containment should be established and alternatives considered based upon the circumstances and available resources.

When a foot pursuit terminates, the officer will notify the dispatcher of his/her location and the status of the pursuit termination (e.g., suspect in custody, lost sight of suspect), and will direct further actions as reasonably appear necessary, to include requesting medical aid as needed for officers, suspects or members of the public.

Culver City Police Department

Culver City PD Policy Manual

Foot Pursuits

427.4.2 ASSISTING OFFICER RESPONSIBILITIES

Whenever any officer announces that he/she is engaged in a foot pursuit, all other officers should minimize non-essential radio traffic to permit the involved officers maximum access to the radio frequency.

427.4.3 SUPERVISOR RESPONSIBILITIES

Upon becoming aware of a foot pursuit, the supervisor shall make every reasonable effort to ascertain sufficient information to direct responding resources and to take command, control and coordination of the foot pursuit. The supervisor should respond to the area whenever possible; the supervisor does not, however, need not be physically present to exercise control over the foot pursuit. The supervisor shall continuously assess the situation in order to ensure the foot pursuit is conducted within established department guidelines.

The supervisor shall terminate the foot pursuit when the danger to pursuing officers or the public appears to unreasonably outweigh the objective of immediate apprehension of the suspect.

Upon apprehension of the suspect, the supervisor shall promptly proceed to the termination point to direct the post-foot pursuit activity.

427.4.4 SOUTHBAY RCC RESPONSIBILITIES

Upon notification or becoming aware that a foot pursuit is in progress, the dispatcher is responsible for:

- (a) Clearing the radio channel of non-emergency traffic.
- (b) Coordinating pursuit communications of the involved officers.
- (c) Broadcasting pursuit updates as well as other pertinent information as necessary.
- (d) Ensuring that a field supervisor is notified of the foot pursuit.
- (e) Notifying and coordinating with other involved or affected agencies as practicable.
- (f) Notifying the Watch Commander as soon as practicable.
- (g) Assigning an incident number and logging all pursuit activities.

427.5 REPORTING REQUIREMENTS

The initiating officer shall complete appropriate crime/arrest reports documenting, at minimum:

- (a) Date and time of the foot pursuit.
- (b) Initial reason and circumstances surrounding the foot pursuit.
- (c) Course and approximate distance of the foot pursuit.
- (d) Alleged offenses.
- (e) Involved vehicles and officers.
- (f) Whether a suspect was apprehended as well as the means and methods used.

Culver City Police Department

Culver City PD Policy Manual

Foot Pursuits

1. Any use of force shall be reported and documented in compliance with the Use of Force Policy.
 - (g) Arrestee information, if applicable.
 - (h) Any injuries and/or medical treatment.
 - (i) Any property or equipment damage.
 - (j) Name of the supervisor at the scene or who handled the incident.

Assisting officers taking an active role in the apprehension of the suspect shall complete supplemental reports as necessary or as directed.

The supervisor reviewing the report will make a preliminary determination that the pursuit appears to be in compliance with this policy or that additional review and/or follow-up is warranted.

In any case in which a suspect is not apprehended and there is insufficient information to support further investigation, a supervisor may authorize that the initiating officer need not complete a formal report.

427.6 POLICY

It is the policy of this department that officers, when deciding to initiate or continue a foot pursuit, continuously balance the objective of apprehending the suspect with the risk and potential for injury to department members, the public or the suspect.

Officers are expected to act reasonably, based on the totality of the circumstances.

Automated License Plate Readers (ALPRs)

428.1 PURPOSE AND SCOPE

The purpose of this policy is to provide guidance for the capture, storage and use of digital data obtained through the use of Automated License Plate Reader (ALPR) technology.

428.2 DEFINITIONS

(a) Automated License Plate Reader (ALPR): A device that uses cameras and computer technology to compare digital images to lists of known information of interest.

(b) ALPR Operator: Trained Department members who may utilize ALPR system/equipment. ALPR operators may be assigned to any position within the Department, and the ALPR Administrator may order the deployment of the ALPR systems for use in various efforts.

(c) ALPR Administrator: The Special Operations Bureau Captain or the Chief's designee, serves as the ALPR Administrator for the Department.

(d) Hot List: A list of license plates associated with vehicles of interest compiled from one or more databases including, but not limited to, NCIC, CA DMV, Local BOLO's, Silver and Amber Alerts etc.

(e) Vehicles of Interest: Including, but not limited to vehicles which are reported as stolen; display stolen license plates or tags; vehicles linked to missing and/or wanted persons and vehicles flagged by the Department of Motor Vehicle Administration or law enforcement agencies.

(f) Detection: Data obtained by an ALPR of an image (such as a license plate) within public view that was read by the ALPR, including potential images (such as the plate and description of vehicle on which it was displayed), and information regarding the location of the ALPR system at the time of the ALPR's read.

(g) Hit: Alert from the ALPR system that a scanned license plate number may be in the National Crime Information Center (NCIC) or other law enforcement database for a specific reason including, but not limited to, being related to a stolen car, wanted person, missing person, domestic violation protective order or terrorist-related activity.

428.3 OPERATIONS

Use of an ALPR is restricted to the purposes outlined below. Department members shall not use, or allow others to use the equipment or database records for any unauthorized purpose (Civil Code § 1798.90.51; Civil Code § 1798.90.53).

- (a) An ALPR shall only be used for official law enforcement business.
- (b) An ALPR may be used in conjunction with any routine patrol operation or criminal investigation. Reasonable suspicion or probable cause is not required before using an ALPR.
- (c) While an ALPR may be used to canvass license plates around any crime scene, particular consideration should be given to using ALPR-equipped cars to canvass

Culver City Police Department

Culver City PD Policy Manual

Automated License Plate Readers (ALPRs)

areas around homicides, shootings and other major incidents. Partial license plates reported during major crimes should be entered into the ALPR system in an attempt to identify suspect vehicles.

- (d) No member of this department shall operate ALPR equipment or access ALPR data without first completing department-approved training.
- (e) No ALPR operator may access department, state or federal data unless otherwise authorized to do so.
- (f) If practicable, the officer should verify an ALPR response through the California Law Enforcement Telecommunications System (CLETS) before taking enforcement action that is based solely on an ALPR alert.

428.3.1 ALPR ADMINISTRATOR

The Special Operations Bureau Captain shall be responsible for ensuring compliance with the requirements of Civil Code § 1798.90.5 et seq. This includes, but is not limited to (Civil Code § 1798.90.51; Civil Code § 1798.90.53):

- (a) Only properly trained sworn officers, crime analysts, communication operators, records clerks and police assistants are allowed access to the ALPR system or to collect ALPR information.
- (b) Ensuring that training requirements are completed for all authorized users.
- (c) ALPR system monitoring to ensure the security of the information and compliance with applicable privacy laws.
- (d) Ensuring that procedures are followed for system operators and to maintain records of access in compliance with Civil Code § 1798.90.52.
- (e) The title and name of the current designee in overseeing the ALPR operation is maintained. Continually working with the Custodian of Records on the retention and destruction of ALPR data.
- (f) Ensuring this policy and related procedures are conspicuously posted on the Department's website.

428.4 ACCOUNTABILITY

All data will be closely safeguarded and protected by both procedural and technological means. The Culver City Police Department will observe the following safeguards regarding access to and use of stored data (Civil Code § 1798.90.51; Civil Code § 1798.90.53):

- (a) All ALPR data downloaded to the mobile workstation and in storage shall be accessible only through a login/password-protected system capable of documenting all access of information by name, date and time (Civil Code § 1798.90.52).
- (b) Members approved to access ALPR data under these guidelines are permitted to access the data for legitimate law enforcement purposes only, such as when the data relate to a specific criminal investigation or department-related civil or administrative action.

Culver City Police Department

Culver City PD Policy Manual

Automated License Plate Readers (ALPRs)

- (c) ALPR system audits should be conducted on a regular basis.

For security or data breaches, see the Records Release and Maintenance Policy.

428.5 POLICY

The policy of the Culver City Police Department is to utilize ALPR technology to capture and store digital license plate data and images while recognizing the established privacy rights of the public.

All data and images gathered by the ALPR are for the official use of this Department. Because such data may contain confidential information, it is not open to public review.

The Culver City Police Department does not permit the sharing of ALPR data gathered by the city or its contractors/subcontractors for purpose of federal immigration enforcement, pursuant to the California Values Act (Government Code § 7282.5; Government Code § 7284.2 et seq) – these federal immigration agencies include Immigrations and Customs Enforcement (ICE) and Customs and Border Patrol (CBP).

The Culver City Police Department does not permit the sharing or use of ALPR data gathered by the city or its contractors/subcontractors for the purpose of investigating and/or participating in the arrest of any person for performing, supporting, or aiding in the performance of an abortion or gender affirming treatment, or for obtaining an abortion or any type of gender affirming treatment in the state of California, that is lawful under the laws of the state of California, pursuant to Assembly Bill 1242 (which amends Sections 629.51, 629.52, 638.50, 638.52, 1269 (b), 1524, 1524.2, and 1551 of, and adds Sections 1546.5 and 13778.2 to, the Penal Code). Additionally, the Culver City Police Department does not permit providing ALPR data to any law enforcement agency or a federal law enforcement agency for the purposes of investigating out of state abortion laws or laws related to gender affirming treatment.

428.6 ALPR DATA DETECTION BROWSING AUDITS

It is the responsibility of the Professional Standards Unit (PSU) Lieutenant or the Chief's designee to ensure that an audit is conducted of ALPR detection browsing inquiries at least once during each calendar year. The Department will audit a sampling of the ALPR system utilization from the prior 12-month period to verify proper use in accordance with the above- authorized uses. The audit shall randomly select at least 10 detection browsing inquiries conducted by Department employees during the preceding six-month period and determine if each inquiry meets the requirements established in section 426.6 of this policy.

The audit shall be documented in the form of an internal Department memorandum to the Chief of Police. The memorandum shall include any data errors found so that such errors can be corrected.

After review by the Chief of Police, the memorandum and any associated documentation shall be filed and retained by PSU.

428.7 DATA SHARING

All data obtained from the ALPR cameras is owned by the Culver City Police Department. The Culver City Police Department shall maintain robust security procedures and practices, including

Culver City Police Department

Culver City PD Policy Manual

Automated License Plate Readers (ALPRs)

operational, administrative, technical, and physical safeguards, to protect ALPR information from unauthorized access, destruction, use, modification, or disclosure. The Administrator of the data collection will not share information with Immigration and Customs Enforcement (ICE) or any agency conducting immigration enforcement or removal operations. The Administrator of the data collection will not share ALPR data with any law enforcement agency or federal law enforcement agency for the purpose of investigating and/or participating in the arrest of any person for performing, supporting, or aiding in the performance of an abortion or any type of gender affirming treatment or for obtaining an abortion or any type of gender affirming treatment that is lawful under the laws of the state of California.

It is the sole discretion of the Culver City Police Department whether to share its ALPR data with any other State Law Enforcement agency.

ALPR data collected by the Culver City Police Department shall not be sold under any circumstances.

428.8 RELEASING ALPR DATA

The ALPR data may be shared only with other law enforcement or prosecutorial agencies when there is a need to know, a right to know or legal obligation to provide the information.

(a) The agency makes a written request for the ALPR data that includes:

- (1) The name of the agency.
- (2) The name of the person requesting.
- (3) The intended purpose of obtaining the information.

(b) The request is reviewed by the Chief of Police or the authorized designee and approved before the request is fulfilled.

(c) The Chief of Police or the authorized designee will consider the California Values Act (Government Code § 7282.5; Government Code § 7284.2 et seq), before approving the release of ALPR data. The Culver City Police Department does not permit the sharing of ALPR data gathered by the City or its contractors/subcontractors for purpose of federal immigration enforcement, these federal immigration agencies include Immigrations and Customs Enforcement (ICE) and Customs and Border Patrol (CPB).

(d) The Chief of Police or the authorized designee will consider Assembly Bill 1242 (which amends Sections 629.51, 629.52, 638.50, 638.52, 1269b, 1524, 1524.2, and 1551 of, and adds Sections 1546.5 and 13778.2 to, the Penal Code) before approving the release of ALPR data. The Culver City Police Department does not permit the sharing of ALPR data gathered by the City or its contractors/subcontractors for purpose of investigating and/or participating in the arrest of any person for performing, supporting, or aiding in the performance of an abortion or any type of gender affirming treatment, or for obtaining an abortion or any type of gender affirming treatment within the state of California that is lawful under the laws of the state of California.

Culver City Police Department

Culver City PD Policy Manual

Automated License Plate Readers (ALPRs)

(e) The approved request is retained on file. Requests for ALPR data by non-law enforcement or non-prosecutorial agencies will be processed as provided in the Records Maintenance and Release Policy (Civil Code § 1798.90.55).

428.9 TRAINING

The Personnel and Training Sergeant should ensure that members receive Department-approved training for those authorized to use or access the ALPR system (Civil Code § 1798.90.51; Civil Code § 1798.90.53).

Homeless Persons

429.1 PURPOSE AND SCOPE

The purpose of this policy is to ensure that personnel understand the needs and rights of the homeless and to establish procedures to guide officers during all contacts with the homeless, whether consensual or for enforcement purposes. The Culver City Police Department recognizes that members of the homeless community are often in need of special protection and services. The Culver City Police Department will address these needs in balance with the overall mission of this department. Therefore, officers will consider the following when serving the homeless community.

429.1.1 POLICY

It is the policy of the Culver City Police Department to provide law enforcement services to all members of the community, while protecting the rights, dignity and private property of the homeless. Homelessness is not a crime and members of this department will not use homelessness solely as a basis for detention or law enforcement action.

429.2 HOMELESS COMMUNITY LIAISON

The Chief of Police will designate a member of this department to act as the Homeless Liaison Officer. The responsibilities of the Homeless Liaison Officer include the following:

- (a) Maintain and make available to all department employees a list of assistance programs and other resources that are available to the homeless.
- (b) Meet with social services and representatives of other organizations that render assistance to the homeless.
- (c) Maintain a list of the areas within and near this jurisdiction that are used as frequent homeless encampments.
- (d) Remain abreast of laws dealing with the removal and/or destruction of the personal property of the homeless. This will include:
 1. Proper posting of notices of trespass and clean-up operations.
 2. Proper retention of property after clean-up, to include procedures for owners to reclaim their property in accordance with the Property and Evidence Policy and other established procedures.
- (e) Be present during any clean-up operation conducted by this department involving the removal of personal property of the homeless to ensure that the rights of the homeless are not violated.
- (f) Develop training to assist officers in understanding current legal and social issues relating to the homeless.

Culver City Police Department

Culver City PD Policy Manual

Homeless Persons

429.3 FIELD CONTACTS

Officers are encouraged to contact the homeless for purposes of rendering aid, support and for community-oriented policing purposes. Nothing in this policy is meant to dissuade an officer from taking reasonable enforcement action when facts support a reasonable suspicion of criminal activity. However, when encountering a homeless person who has committed a non-violent misdemeanor and continued freedom is not likely to result in a continuation of the offense or a breach of the peace, officers are encouraged to consider long-term solutions to problems that may relate to the homeless, such as shelter referrals and counseling in lieu of physical arrest.

Officers should provide homeless persons with resource and assistance information whenever it is reasonably apparent that such services may be appropriate.

429.3.1 OTHER CONSIDERATIONS

Homeless members of the community will receive the same level and quality of service provided to other members of the community. The fact that a victim or witness is homeless can, however, require special considerations for a successful investigation and prosecution. Officers should consider the following when handling investigations involving homeless victims, witnesses or suspects:

- (a) Document alternate contact information. This may include obtaining addresses and phone numbers of relatives and friends.
- (b) Document places the homeless person may frequent.
- (c) Provide homeless victims with victim/witness resources when appropriate.
- (d) Obtain statements from all available witnesses in the event that a homeless victim is unavailable for a court appearance.
- (e) Consider whether the person may be a dependent adult or elder, and if so, proceed in accordance with the Senior and Disability Victimization Policy.
- (f) Arrange for transportation for investigation-related matters, such as medical exams and court appearances.
- (g) Consider whether a crime should be reported and submitted for prosecution, even when a homeless victim indicates that he/she does not desire prosecution.

429.4 PERSONAL PROPERTY

The personal property of homeless persons must not be treated differently than the property of other members of the public. Officers should use reasonable care when handling, collecting and retaining the personal property of homeless persons and should not destroy or discard the personal property of a homeless person.

When a homeless person is arrested or otherwise removed from a public place, officers should make reasonable accommodations to permit the person to lawfully secure his/her personal property. Otherwise, the personal property should be collected for safekeeping. If the arrestee has more personal property than can reasonably be collected and transported by the officer, a supervisor should be consulted. The property should be photographed and measures should be

Culver City Police Department

Culver City PD Policy Manual

Homeless Persons

taken to remove or secure the property. It will be the supervisor's responsibility to coordinate the removal and safekeeping of the property.

Officers should not conduct or assist in clean-up operations of belongings that reasonably appear to be the property of homeless persons without the prior authorization of a supervisor or the department Homeless Liaison Officer. When practicable, requests by the public for clean-up of a homeless encampment should be referred to the Homeless Liaison Officer.

Officers who encounter unattended encampments, bedding or other personal property in public areas that reasonably appears to belong to a homeless person should not remove or destroy such property and should inform the department Homeless Liaison Officer if such property appears to involve a trespass, blight to the community or is the subject of a complaint. It will be the responsibility of the Homeless Liaison Officer to address the matter in a timely fashion.

429.5 MENTAL ILLNESS AND MENTAL IMPAIRMENT

Some homeless persons may suffer from a mental illness or a mental impairment. Officers shall not detain a homeless person under a mental illness commitment unless facts and circumstances warrant such a detention (see the Crisis Intervention Incidents Policy).

When a mental illness hold is not warranted, the contacting officer should provide the homeless person with contact information for mental health assistance as appropriate. In these circumstances, officers may provide transportation to a mental health specialist if requested by the person and approved by a supervisor.

429.6 ECOLOGICAL ISSUES

Sometimes homeless encampments can impact the ecology and natural resources of the community and may involve criminal offenses beyond mere littering. Officers are encouraged to notify other appropriate agencies or departments when a significant impact to the environment has or is likely to occur. Significant impacts to the environment may warrant a crime report, investigation, supporting photographs and supervisor notification.

Public Recording of Law Enforcement Activity

430.1 PURPOSE AND SCOPE

This policy provides guidelines for handling situations in which members of the public photograph or audio/video record law enforcement actions and other public activities that involve members of this department. In addition, this policy provides guidelines for situations where the recordings may be evidence.

430.2 POLICY

The Culver City Police Department recognizes the right of persons to lawfully record members of this department who are performing their official duties. Members of this department will not prohibit or intentionally interfere with such lawful recordings. Any recordings that are deemed to be evidence of a crime or relevant to an investigation will only be collected or seized lawfully.

Officers should exercise restraint and should not resort to highly discretionary arrests for offenses such as interference, failure to comply or disorderly conduct as a means of preventing someone from exercising the right to record members performing their official duties.

430.3 RECORDING LAW ENFORCEMENT ACTIVITY

Members of the public who wish to record law enforcement activities are limited only in certain aspects.

- (a) Recordings may be made from any public place or any private property where the individual has the legal right to be present (Penal Code § 69; Penal Code § 148).
- (b) Beyond the act of photographing or recording, individuals may not interfere with the law enforcement activity. Examples of interference include, but are not limited to:
 - 1. Tampering with a witness or suspect.
 - 2. Inciting others to violate the law.
 - 3. Being so close to the activity as to present a clear safety hazard to the officers.
 - 4. Being so close to the activity as to interfere with an officer's effective communication with a suspect or witness.
- (c) The individual may not present an undue safety risk to the officers, him/herself or others.

430.4 OFFICER RESPONSE

Officers should promptly request that a supervisor respond to the scene whenever it appears that anyone recording activities may be interfering with an investigation or it is believed that the recording may be evidence. If practicable, officers should wait for the supervisor to arrive before taking enforcement action or seizing any cameras or recording media.

Whenever practicable, officers or supervisors should give clear and concise warnings to individuals who are conducting themselves in a manner that would cause their recording or behavior to be unlawful. Accompanying the warnings should be clear directions on what an

Culver City Police Department

Culver City PD Policy Manual

Public Recording of Law Enforcement Activity

individual can do to be compliant; directions should be specific enough to allow compliance. For example, rather than directing an individual to clear the area, an officer could advise the person that he/she may continue observing and recording from the sidewalk across the street.

If an arrest or other significant enforcement activity is taken as the result of a recording that interferes with law enforcement activity, officers shall document in a report the nature and extent of the interference or other unlawful behavior and the warnings that were issued.

430.5 SUPERVISOR RESPONSIBILITIES

A supervisor should respond to the scene when requested or any time the circumstances indicate a likelihood of interference or other unlawful behavior.

The supervisor should review the situation with the officer and:

- (a) Request any additional assistance as needed to ensure a safe environment.
- (b) Take a lead role in communicating with individuals who are observing or recording regarding any appropriate limitations on their location or behavior. When practical, the encounter should be recorded.
- (c) When practicable, allow adequate time for individuals to respond to requests for a change of location or behavior.
- (d) Ensure that any enforcement, seizure or other actions are consistent with this policy and constitutional and state law.
- (e) Explain alternatives for individuals who wish to express concern about the conduct of Department members, such as how and where to file a complaint.

430.6 SEIZING RECORDINGS AS EVIDENCE

Officers should not seize recording devices or media unless (42 USC § 2000aa):

- (a) There is probable cause to believe the person recording has committed or is committing a crime to which the recording relates, and the recording is reasonably necessary for prosecution of the person.
 1. Absent exigency or consent, a warrant should be sought before seizing or viewing such recordings. Reasonable steps may be taken to prevent erasure of the recording.
- (b) There is reason to believe that the immediate seizure of such recordings is necessary to prevent serious bodily injury or death of any person.
- (c) The person consents.
 1. To ensure that the consent is voluntary, the request should not be made in a threatening or coercive manner.
 2. If the original recording is provided, a copy of the recording should be provided to the recording party, if practicable. The recording party should be permitted to be present while the copy is being made, if feasible. Another way to obtain the evidence is to transmit a copy of the recording from a device to a department-owned device.

Culver City Police Department

Culver City PD Policy Manual

Public Recording of Law Enforcement Activity

Recording devices and media that are seized will be submitted within the guidelines of the Property and Evidence Policy.

Crisis Intervention Incidents

431.1 PURPOSE AND SCOPE

This policy provides guidelines for interacting with those who may be experiencing a mental health or emotional crisis. Interaction with such individuals has the potential for miscommunication and violence. It often requires an officer to make difficult judgments about a person's mental state and intent in order to effectively and legally interact with the individual.

431.1.1 DEFINITIONS

Definitions related to this policy include:

Person in crisis - A person whose level of distress or mental health symptoms have exceeded the person's internal ability to manage his/her behavior or emotions. A crisis can be precipitated by any number of things, including an increase in the symptoms of mental illness despite treatment compliance; non-compliance with treatment, including a failure to take prescribed medications appropriately; or any other circumstance or event that causes the person to engage in erratic, disruptive or dangerous behavior that may be accompanied by impaired judgment.

431.2 POLICY

The Culver City Police Department is committed to providing a consistently high level of service to all members of the community and recognizes that persons in crisis may benefit from intervention. The Department will collaborate, where feasible, with mental health professionals to develop an overall intervention strategy to guide its members' interactions with those experiencing a mental health crisis. This is to ensure equitable and safe treatment of all involved.

431.3 SIGNS

Members should be alert to any of the following possible signs of mental health issues or crises:

- (a) A known history of mental illness
- (b) Threats of or attempted suicide
- (c) Loss of memory
- (d) Incoherence, disorientation or slow response
- (e) Delusions, hallucinations, perceptions unrelated to reality or grandiose ideas
- (f) Depression, pronounced feelings of hopelessness or uselessness, extreme sadness or guilt
- (g) Social withdrawal
- (h) Manic or impulsive behavior, extreme agitation, lack of control
- (i) Lack of fear
- (j) Anxiety, aggression, rigidity, inflexibility or paranoia

Members should be aware that this list is not exhaustive. The presence or absence of any of these should not be treated as proof of the presence or absence of a mental health issue or crisis.

Culver City Police Department

Culver City PD Policy Manual

Crisis Intervention Incidents

431.4 COORDINATION WITH MENTAL HEALTH PROFESSIONALS

The Chief of Police should designate an appropriate Bureau Commander to collaborate with mental health professionals to develop an education and response protocol. It should include a list of community resources, to guide department interaction with those who may be suffering from mental illness or who appear to be in a mental health crisis.

431.5 FIRST RESPONDERS

Safety is a priority for first responders. It is important to recognize that individuals under the influence of alcohol, drugs or both may exhibit symptoms that are similar to those of a person in a mental health crisis. These individuals may still present a serious threat to officers; such a threat should be addressed with reasonable tactics. Nothing in this policy shall be construed to limit an officer's authority to use reasonable force when interacting with a person in crisis.

Officers are reminded that mental health issues, mental health crises and unusual behavior alone are not criminal offenses. Individuals may benefit from treatment as opposed to incarceration.

An officer responding to a call involving a person in crisis should:

- (a) Promptly assess the situation independent of reported information and make a preliminary determination regarding whether a mental health crisis may be a factor.
- (b) Request available backup officers and specialized resources as deemed necessary and, if it is reasonably believed that the person is in a crisis situation, use conflict resolution and de-escalation techniques to stabilize the incident as appropriate.
- (c) If feasible, and without compromising safety, turn off flashing lights, bright lights or sirens.
- (d) Attempt to determine if weapons are present or available.
 1. Prior to making contact, and whenever possible and reasonable, conduct a search of the Department of Justice Automated Firearms System via the California Law Enforcement Telecommunications System (CLETS) to determine whether the person is the registered owner of a firearm (Penal Code § 11106.4).
- (e) Take into account the person's mental and emotional state and potential inability to understand commands or to appreciate the consequences of his/her action or inaction, as perceived by the officer.
- (f) Secure the scene and clear the immediate area as necessary.
- (g) Employ tactics to preserve the safety of all participants.
- (h) Determine the nature of any crime.
- (i) Request a supervisor, as warranted.
- (j) Evaluate any available information that might assist in determining cause or motivation for the person's actions or stated intentions.
- (k) If circumstances reasonably permit, consider and employ alternatives to force.

Culver City Police Department

Culver City PD Policy Manual

Crisis Intervention Incidents

431.6 DE-ESCALATION

Officers should consider that taking no action or passively monitoring the situation may be the most reasonable response to a mental health crisis.

Once it is determined that a situation is a mental health crisis and immediate safety concerns have been addressed, responding members should be aware of the following considerations and should generally:

- Evaluate safety conditions.
- Introduce themselves and attempt to obtain the person's name.
- Be patient, polite, calm, courteous and avoid overreacting.
- Speak and move slowly and in a non-threatening manner.
- Moderate the level of direct eye contact.
- Remove distractions or disruptive people from the area.
- Demonstrate active listening skills (e.g., summarize the person's verbal communication).
- Provide for sufficient avenues of retreat or escape should the situation become volatile.

Responding officers generally should not:

- Use stances or tactics that can be interpreted as aggressive.
- Allow others to interrupt or engage the person.
- Corner a person who is not believed to be armed, violent or suicidal.
- Argue, speak with a raised voice or use threats to obtain compliance.

431.7 INCIDENT ORIENTATION

When responding to an incident that may involve mental illness or a mental health crisis, the officer should request that the dispatcher provide critical information as it becomes available. This includes:

- (a) Whether the person relies on drugs or medication, or may have failed to take his/her medication.
- (b) Whether there have been prior incidents, suicide threats/attempts, and whether there has been previous police response.
- (c) Contact information for a treating physician or mental health professional.

Additional resources and a supervisor should be requested as warranted.

431.8 SUPERVISOR RESPONSIBILITIES

A supervisor should respond to the scene of any interaction with a person in crisis. Responding supervisors should:

- (a) Attempt to secure appropriate and sufficient resources.

Culver City Police Department

Culver City PD Policy Manual

Crisis Intervention Incidents

- (b) Closely monitor any use of force, including the use of restraints, and ensure that those subjected to the use of force are provided with timely access to medical care (see the Handcuffing and Restraints Policy).
- (c) Consider strategic disengagement. Absent an imminent threat to the public and, as circumstances dictate, this may include removing or reducing law enforcement resources or engaging in passive monitoring.
- (d) Ensure that all reports are completed and that incident documentation uses appropriate terminology and language.
- (e) Conduct an after-action tactical and operational debriefing, and prepare an after-action evaluation of the incident to be forwarded to the Bureau Commander.

Evaluate whether a critical incident stress management debriefing for involved members is warranted.

431.9 INCIDENT REPORTING

Members engaging in any oral or written communication associated with a mental health crisis should be mindful of the sensitive nature of such communications and should exercise appropriate discretion when referring to or describing persons and circumstances.

Members having contact with a person in crisis should keep related information confidential, except to the extent that revealing information is necessary to conform to department reporting procedures or other official mental health or medical proceedings.

[All contacts with persons in crisis are to be noted by officers in the call disposition as Mental Health Related.](#)

431.9.1 DIVERSION

Individuals who are not being arrested should be processed in accordance with the Mental Illness Commitments Policy.

431.10 PROFESSIONAL STAFF INTERACTION WITH PEOPLE IN CRISIS

Professional Staff members may be required to interact with persons in crisis in an administrative capacity, such as dispatching, records request, and animal control issues.

- (a) Members should treat all individuals equally and with dignity and respect.
- (b) If a member believes that he/she is interacting with a person in crisis, he/she should proceed patiently and in a calm manner.
- (c) Members should be aware and understand that the person may make unusual or bizarre claims or requests.

If a person's behavior makes the member feel unsafe, if the person is or becomes disruptive or violent, or if the person acts in such a manner as to cause the member to believe that the person may be harmful to him/herself or others, an officer should be promptly summoned to provide assistance.

Culver City Police Department

Culver City PD Policy Manual

Crisis Intervention Incidents

431.11 EVALUATION

The Bureau Commander designated to coordinate the crisis intervention strategy for this department should ensure that a thorough review and analysis of the department response to these incidents is conducted annually. The report will not include identifying information pertaining to any involved individuals, officers or incidents and will be submitted to the Chief of Police through the chain of command.

431.12 TRAINING

In coordination with the mental health community and appropriate stakeholders, the Department will develop and provide comprehensive education and training to all department members to enable them to effectively interact with persons in crisis.

This department will endeavor to provide Peace Officer Standards and Training (POST)-approved advanced officer training on interaction with persons with mental disabilities, welfare checks and crisis intervention (Penal Code § 11106.4; Penal Code § 13515.25; Penal Code § 13515.27; Penal Code § 13515.30).

First Amendment Assemblies

432.1 PURPOSE AND SCOPE

This policy provides guidance for responding to public assemblies or demonstrations.

432.2 POLICY

The Culver City Police Department respects the rights of people to peaceably assemble. It is the policy of this department not to unreasonably interfere with, harass, intimidate or discriminate against persons engaged in the lawful exercise of their rights, while also preserving the peace, protecting life and preventing the destruction of property.

432.3 GENERAL CONSIDERATIONS

Individuals or groups present on the public way, such as public facilities, streets or walkways, generally have the right to assemble, rally, demonstrate, protest or otherwise express their views and opinions through varying forms of communication, including the distribution of printed matter. These rights may be limited by laws or ordinances regulating such matters as the obstruction of individual or vehicle access or egress, trespass, noise, picketing, distribution of handbills and leafleting, and loitering. However, officers shall not take action or fail to take action based on the opinions being expressed.

Participant behavior during a demonstration or other public assembly can vary. This may include, but is not limited to:

- Lawful, constitutionally protected actions and speech.
- Civil disobedience (typically involving minor criminal acts).
- Rioting (Violent and/or felonious public disorder by a group or crowd of persons).

All of these behaviors may be present during the same event. Therefore, it is imperative that law enforcement actions are measured and appropriate for the behaviors officers may encounter. This is particularly critical if force is being used. Adaptable strategies and tactics are essential. The purpose of a law enforcement presence at the scene of public assemblies and demonstrations should be to preserve the peace, to protect life and prevent the destruction of property.

Officers should not:

- (a) Engage in assembly or demonstration-related discussion with participants.
- (b) Harass, confront or intimidate participants.
- (c) Seize the cameras, cell phones or materials of participants or observers unless an officer is placing a person under lawful arrest.

Supervisors should continually observe department members under their commands to ensure that members' interaction with participants and their response to crowd dynamics is appropriate.

Culver City Police Department

Culver City PD Policy Manual

First Amendment Assemblies

432.3.1 PHOTOGRAPHS AND VIDEO RECORDINGS

Photographs and video recording, when appropriate, can serve a number of purposes, including support of criminal prosecutions by documenting criminal acts; assistance in evaluating department performance; serving as training material; recording the use of dispersal orders; and facilitating a response to allegations of improper law enforcement conduct.

Photographs and videos will not be used or retained for the sole purpose of collecting or maintaining information about the political, religious, or social views of associations, or the activities of any individual, group, association, organization, corporation, business, or partnership, unless such information directly relates to an investigation of criminal activities and there is reasonable suspicion that the subject of the information is involved in criminal conduct.

432.4 UNPLANNED EVENTS

When responding to an unplanned or spontaneous public gathering, the first responding officer should conduct an assessment of conditions, including, but not limited to, the following:

- Location
- Number of participants
- Apparent purpose of the event
- Leadership (whether it is apparent and/or whether it is effective)
- Any initial indicators of unlawful or disruptive activity
- Indicators that lawful use of public facilities, streets or walkways will be impacted
- Ability and/or need to continue monitoring the incident
- Counter protestors present

Initial assessment information should be promptly communicated to Southbay RCC, and the assignment of a supervisor should be requested. Additional resources should be requested as appropriate. The responding supervisor shall assume command of the incident until command is expressly assumed by another, and the assumption of command is communicated to the involved members. A clearly defined command structure that is consistent with the Incident Command System (ICS) should be established as resources are deployed.

432.5 PLANNED EVENT PREPARATION

It is the responsibility of the Special Operations Lieutenant to develop and approve comprehensive incident specific operational plan for planned events. The ICS should be considered for such events.

432.5.1 INFORMATION GATHERING AND ASSESSMENT

In order to properly assess the potential impact of a public assembly or demonstration on public safety and order, relevant information should be collected and vetted. This may include:

- Information obtained from outreach to group organizers or leaders.

Culver City Police Department

Culver City PD Policy Manual

First Amendment Assemblies

- Information about past and potential unlawful conduct associated with the event or similar events.
- The potential time, duration, scope, and type of planned activities.
- Any other information related to the goal of providing a balanced response to criminal activity and the protection of public safety interests.
- Information obtained through social media outlets.

Information should be obtained in a transparent manner, and the sources documented. Relevant information should be communicated to the appropriate parties in a timely manner.

Information will be obtained in a lawful manner and will not be based solely on the purpose or content of the assembly or demonstration, or actual or perceived characteristics such as race, ethnicity, national origin, religion, sex, sexual orientation, gender identity or expression, economic status, age, cultural group, or disability of the participants (or any other characteristic that is unrelated to criminal conduct or the identification of a criminal subject).

432.5.2 OPERATIONAL PLANS

An operational planning team with responsibility for event planning and management should be established. The planning team at the direction of the Special Operations Lieutenant should develop an operational plan for the event.

The operational plan will minimally provide for:

- (a) Command assignments, chain of command structure, roles and responsibilities.
- (b) Staffing and resource allocation.
- (c) Management of criminal investigations.
- (d) Designation of uniform of the day and related safety equipment (e.g., helmets, shields).
- (e) Deployment of specialized resources.
- (f) Event communications and interoperability in a multijurisdictional event.
- (g) Liaison with demonstration leaders and external agencies.
- (h) Liaison with City government and legal staff.
- (i) Media relations.
- (j) Logistics: food, fuel, replacement equipment, duty hours, relief and transportation.
- (k) Traffic management plans.
- (l) First aid and emergency medical service provider availability.
- (m) Prisoner transport and detention.
- (n) Review of policies regarding public assemblies and use of force in crowd control.
- (o) Parameters for declaring an unlawful assembly.
- (p) Arrest protocol, including management of mass arrests.

Culver City Police Department

Culver City PD Policy Manual

First Amendment Assemblies

- (q) Protocol for recording information flow and decisions.
- (r) Rules of engagement, including rules of conduct, protocols for field force extraction and arrests, and any authorization required for the use of force.
- (s) Protocol for handling complaints during the event.
- (t) Parameters for the use of body-worn cameras and other portable recording devices.

432.5.3 MUTUAL AID AND EXTERNAL RESOURCES

The magnitude and anticipated duration of an event may necessitate interagency cooperation and coordination. The Special Operations Lieutenant should ensure that any required memorandums of understanding or other agreements are properly executed, and that any anticipated mutual aid is requested and facilitated (see the 406- Mutual Aid and Tactical Mobilization and 328- Outside Agency Assistance Policies).

432.6 UNLAWFUL ASSEMBLY DISPERSAL ORDERS

If a public gathering or demonstration remains peaceful and nonviolent, and there is no reasonably imminent threat to persons or property, the Incident Commander should generally authorize continued monitoring of the event.

Should the Incident Commander make a determination that public safety is presently or is about to be jeopardized, he/she or the authorized designee should attempt to verbally persuade event organizers or participants to disperse of their own accord. Warnings and advisements may be communicated through established communications links with leaders and/or participants or to the group.

When initial attempts at verbal persuasion are unsuccessful, the Incident Commander or the authorized designee should make a clear standardized announcement to the gathering that the event is an unlawful assembly, and should order the dispersal of the participants. The announcement should be communicated by whatever methods are reasonably available to ensure that the content of the message is clear and that it has been heard by the participants. The announcement should be amplified, made in different languages as appropriate, made from multiple locations in the affected area and documented by audio and video. The announcement should provide information about what law enforcement actions will take place if illegal behavior continues and should identify routes for egress. A reasonable time to disperse should be allowed following a dispersal order.

432.7 USE OF FORCE

Use of force is governed by current department policy and applicable law (see the Use of Force, Handcuffing and Restraints, Control Devices and Techniques, and Conducted Energy Device policies).

Individuals refusing to comply with lawful orders (e.g., nonviolent refusal to disperse) should be given a clear verbal warning and a reasonable opportunity to comply. If an individual refuses to comply with lawful orders, the Incident Commander shall evaluate the type of resistance and adopt a reasonable response in order to accomplish the law enforcement mission (such as dispersal or

Culver City Police Department

Culver City PD Policy Manual

First Amendment Assemblies

arrest of those acting in violation of the law). Control devices and conducted energy devices should be considered only when the participants' conduct reasonably appears to present the potential to harm officers, themselves or others, or will result in substantial property loss or damage (see the Control Devices and Techniques and the Conducted Energy Device policies).

Force or control devices, including oleoresin capsaicin (OC), should be directed toward individuals and not toward groups or crowds, unless specific individuals cannot reasonably be targeted due to extreme circumstances, such as a riotous crowd.

Any use of force by a member of this department shall be documented promptly, completely, and accurately in an appropriate report. The type of report required may depend on the nature of the incident.

432.8 ARRESTS

The Culver City Police Department should respond to unlawful behavior in a manner that is consistent with the operational plan. If practicable, warnings or advisements should be communicated prior to arrest.

Mass arrests should be employed only when alternate tactics and strategies have been, or reasonably appear likely to be, unsuccessful. Mass arrests shall only be undertaken upon the order of the Incident Commander or the authorized designee. There must be probable cause for each arrest.

If employed, mass arrest protocols should fully integrate:

- (a) Reasonable measures to address the safety of officers and arrestees.
- (b) Dedicated arrest, booking and report writing teams.
- (c) Timely access to medical care.
- (d) Timely access to legal resources.
- (e) Timely processing of arrestees.
- (f) Full accountability for arrestees and evidence.
- (g) Coordination and cooperation with the prosecuting authority, jail and courts (see the Cite and Release Policy).

432.9 MEDIA RELATIONS

The Public Information Officer should use all available avenues of communication, including press releases, briefings, press conferences, and social media to maintain open channels of communication with media representatives and the public about the status and progress of the event, taking all opportunities to reassure the public about the professional management of the event (see the Media Relations Policy).

432.9.1 MEDIA ACCESS

If officers close the immediate area surrounding any emergency field command post or any other command post, or establish a police line, or rolling closure at a demonstration, march, protest,

Culver City Police Department

Culver City PD Policy Manual

First Amendment Assemblies

or rally where individuals are engaged in a protected activity pursuant to the First Amendment, officers shall comply with the requirements of Penal Code § 409.7 relating to media access (i.e., access to closed areas, obtaining information) (Penal Code § 409.7).

432.10 DEMOBILIZATION

When appropriate, the Incident Commander or the authorized designee should implement a phased and orderly withdrawal of law enforcement resources. All relieved personnel should promptly complete any required reports, including use of force reports, and account for all issued equipment and vehicles to their supervisors prior to returning to normal operational duties.

432.11 POST EVENT

The Incident Commander should designate a member to assemble full documentation of the event, to include the following:

- (a) Operational plan
- (b) Any incident logs
- (c) Any assignment logs
- (d) Vehicle, fuel, equipment and supply records
- (e) Incident, arrest, use of force, injury and property damage reports
- (f) Photographs, audio/video recordings, Southbay RCC records/tapes
- (g) Media accounts (print and broadcast media)

432.11.1 AFTER-ACTION REPORTING

The Special Operations Lieutenant should work with City legal counsel, as appropriate, to prepare and maintain comprehensive after-action report of the event, explaining all incidents where force was used including the following:

- (a) Date, time and description of the event
- (b) Actions taken and outcomes (e.g., injuries, property damage, arrests)
- (c) Problems identified
- (d) Significant events
- (e) Recommendations for improvement; opportunities for training should be documented in a generic manner, without identifying individuals or specific incidents, facts or circumstances.

432.12 TRAINING

Department members should receive periodic training regarding this policy, as well as the dynamics of crowd control and incident management (Penal Code § 13514.5). The Department should, when practicable, train with its external and mutual aid partners.

Officers should also receive periodic training on the standards for the use of kinetic energy projectiles and chemical agents for crowd control purposes as identified in Penal Code § 13652.

Culver City Police Department

Culver City PD Policy Manual

First Amendment Assemblies

432.13 USE OF KINETIC ENERGY PROJECTILES AND CHEMICAL AGENTS FOR CROWD CONTROL

Kinetic energy projectiles and chemical agents for crowd control purposes shall only be deployed by officers who have received POST training for crowd control if the use is objectively reasonable to defend against a threat to life or serious bodily injury to any individual, including an officer, or to bring an objectively dangerous and unlawful situation safely and effectively under control and in accordance with the following requirements of Penal Code § 13652. In addition, any use of Kinetic energy projectiles and Chemical Agents shall comply with Department Policy (300) Use of Force, Policy (304) Control Devices-Impact Weapons, and Policy (350) Control Devices-Chemical Agents, as well as federal, state, and local laws and ordinances.

- (a) De-escalation techniques or other alternatives to force have been attempted, when objectively reasonable, and have failed.
- (b) Repeated, audible announcements are made announcing the intent to use kinetic energy projectiles and chemical agents and the type to be used, when objectively reasonable to do so. The announcements shall be made from various locations, if necessary, and delivered in multiple languages, if appropriate.
- (c) Individuals are given an objectively reasonable opportunity to disperse and leave the scene.
- (d) An objectively reasonable effort has been made to identify individuals engaged in violent acts and those who are not, and kinetic energy projectiles or chemical agents are targeted toward those individuals engaged in violent acts. Projectiles shall not be aimed indiscriminately into a crowd or group of individuals.
- (e) Kinetic energy projectiles and chemical agents are used only with the frequency, intensity, and in a manner that is proportional to the threat and objectively reasonable.
- (f) Officers shall minimize the possible incidental impact of their use of kinetic energy projectiles and chemical agents on bystanders, medical personnel, journalists, or other unintended targets.
- (g) An objectively reasonable effort has been made to extract individuals in distress.
- (h) Medical assistance is promptly provided, if properly trained personnel are present, or procured, for injured persons, when it is reasonable and safe to do so.
- (i) Kinetic energy projectiles shall not be aimed at the head, neck, or any other vital organs.
- (j) Kinetic energy projectiles or chemical agents shall not be used solely due to any of the following:
 - 1. A violation of an imposed curfew.
 - 2. A verbal threat.
 - 3. Noncompliance with a law enforcement directive.
- (k) The use of chemical agents for the dispersal of riotous crowds must first be authorized by the Chief of Police.

Culver City Police Department

Culver City PD Policy Manual

First Amendment Assemblies

432.13.1 USE SUMMARY

The Special Operations Commander or the authorized designee should ensure that a summary of each deployment of kinetic energy projectiles or chemical agents for crowd control purposes is prepared and published on the department website within 60 days of each incident. The time frame may be extended for another 30 days where just cause is demonstrated, but no longer than 90 days from the time of the incident. The summary shall be limited to the information known to the Department at the time of the report and include the information required in Penal Code § 13652.1. Additionally, each deployment shall be documented in the department's Annual Military Use report in compliance with Department Policy 704 (Military Equipment, Acquisition, and Use Policy).

432.14 ANTI-REPRODUCTIVE RIGHTS CALLS

Officer response to public assemblies or demonstrations relating to anti-reproductive rights should be consistent with this policy (Penal Code § 13778.1).

Civil Disputes

433.1 PURPOSE AND SCOPE

This policy provides members of the Culver City Police Department with guidance for addressing conflicts between persons when no criminal investigation or enforcement action is warranted (e.g., civil matters), with the goal of minimizing any potential for violence or criminal acts.

The Domestic Violence Policy will address specific legal mandates related to domestic violence court orders. References in this policy to “court orders” apply to any order of a court that does not require arrest or enforcement by the terms of the order or by California law.

433.2 POLICY

The Culver City Police Department recognizes that a law enforcement presence at a civil dispute can play an important role in the peace and safety of the community. Subject to available resources, members of this department will assist at the scene of civil disputes with the primary goal of safeguarding persons and property, preventing criminal activity and maintaining the peace. When handling civil disputes, members will remain impartial, maintain a calm presence, give consideration to all sides and refrain from giving legal or inappropriate advice.

433.3 GENERAL CONSIDERATIONS

When appropriate, members handling a civil dispute should encourage the involved parties to seek the assistance of resolution services or take the matter to the civil courts. Members must not become personally involved in disputes and shall at all times remain impartial.

While not intended to be an exhaustive list, members should give considerations to the following when handling civil disputes:

- (a) Civil disputes tend to be confrontational and members should be alert that they can escalate to violence very quickly. De-escalation techniques should be used when appropriate.
- (b) Members should not dismiss alleged or observed criminal violations as a civil matter and should initiate the appropriate investigation and report when criminal activity is apparent.
- (c) Members shall not provide legal advice, however, when appropriate, members should inform the parties when they are at risk of violating criminal laws.
- (d) Members are reminded that they shall not enter a residence or other non-public location without legal authority including valid consent.
- (e) Members should not take an unreasonable amount of time assisting in these matters and generally should contact a supervisor if it appears that peacekeeping efforts longer than 30 minutes are warranted.

433.4 COURT ORDERS

Disputes involving court orders can be complex. Where no mandate exists for an officer to make an arrest for a violation of a court order, the matter should be addressed by documenting any apparent

Culver City Police Department

Culver City PD Policy Manual

Civil Disputes

court order violation in a report. If there appears to be a more immediate need for enforcement action, the investigating officer should consult a supervisor prior to making any arrest.

If a person appears to be violating the terms of a court order but is disputing the validity of the order or its applicability, the investigating officer should document the following:

- (a) The person's knowledge of the court order or whether proof of service exists.
- (b) Any specific reason or rationale the involved person offers for not complying with the terms of the order.

A copy of the court order should be attached to the report when available. The report should be forwarded to the appropriate prosecutor. The report should also be forwarded to the court issuing the order with a notice that the report was also forwarded to the prosecutor for review.

433.4.1 STANDBY REQUESTS

Officers responding to a call for standby assistance to retrieve property should meet the person requesting assistance at a neutral location to discuss the process. The person should be advised that items that are disputed will not be allowed to be removed. The member may advise the person to seek private legal advice as to the distribution of disputed property.

Members should accompany the person to the location of the property. Members should ask if the other party will allow removal of the property or whether the other party would remove the property.

If the other party is uncooperative, the person requesting standby assistance should be instructed to seek private legal advice and obtain a court order to obtain the items. Officers should not order the other party to allow entry or the removal of any items. If there is a restraining or similar order against the person requesting standby assistance, that person should be asked to leave the scene or they may be subject to arrest for violation of the order.

If the other party is not present at the location, the member will not allow entry into the location or the removal of property from the location.

433.5 VEHICLES AND PERSONAL PROPERTY

Officers may be faced with disputes regarding possession or ownership of vehicles or other personal property. Officers may review documents provided by parties or available databases (e.g., vehicle registration), but should be aware that legal possession of vehicles or personal property can be complex. Generally, officers should not take any enforcement action unless a crime is apparent. The people and the vehicle or personal property involved should be identified and the incident documented.

433.6 REAL PROPERTY

Disputes over possession or occupancy of real property (e.g., land, homes, apartments) should generally be handled through a person seeking a court order.

Suspicious Activity Reporting

434.1 PURPOSE AND SCOPE

This policy provides guidelines for reporting and investigating suspicious and criminal activity.

434.1.1 DEFINITIONS

Definitions related to this policy include:

Involved party - An individual who has been observed engaging in suspicious activity, as defined in this policy, when no definitive criminal activity can be identified, thus precluding the person's identification as a suspect.

Suspicious activity - Any reported or observed activity that a member reasonably believes may have a nexus to any criminal act or attempted criminal act, or to foreign or domestic terrorism. Actual or perceived characteristics such as race, ethnicity, national origin, religion, sex, sexual orientation, gender identity or expression, economic status, age, cultural group, or disability should not be considered as factors that create suspicion (although these factors may be used as specific suspect descriptions). Examples of suspicious activity may include but are not limited to:

- Suspected pre-operational surveillance or intelligence gathering (e.g., photographing security features, asking questions about sensitive security-related subjects).
- Tests of security measures and response to incidents (e.g., "dry run," creating false alarms, attempts to enter secure areas without authorization).
- Suspicious purchases (e.g., purchasing large quantities of otherwise legal items, such as fertilizer, that could be used to create an explosive or other dangerous device).
- An individual in possession of such things as a hoax explosive or dispersal device, sensitive materials (e.g., passwords, access codes, classified government information), or coded or ciphered literature or correspondence.

Suspicious Activity Report (SAR) - An incident report used to document suspicious activity.

434.2 POLICY

The Culver City Police Department recognizes the need to protect the public from criminal conduct and acts of terrorism and shall lawfully collect, maintain and disseminate information regarding suspicious activities, while safeguarding civil liberties and privacy protections.

434.3 RESPONSIBILITIES

The Investigations Bureau Bureau Commander and authorized designees will manage SAR activities. Authorized designees should include supervisors who are responsible for department participation in criminal intelligence systems as outlined in the Criminal Organizations Policy.

The responsibilities of the Investigations Bureau Bureau Commander include, but are not limited to:

- (a) Remaining familiar with those databases available to the Department that would facilitate the purpose of this policy.

Culver City Police Department

Culver City PD Policy Manual

Suspicious Activity Reporting

- (b) Maintaining adequate training in the area of intelligence gathering to ensure no information is being maintained that would violate the law or civil rights of any individual.
- (c) Ensuring a process is available that would allow members to report relevant information. The process should be designed to promote efficient and quick reporting, and should not be cumbersome, duplicative or complicated.
- (d) Ensuring that members are made aware of the purpose and value of documenting information regarding suspicious activity, as well as the databases and other information resources that are available to the Department.
- (e) Ensuring that SAR information is appropriately disseminated to members in accordance with their job responsibilities.
- (f) Coordinating investigative follow-up, if appropriate.
- (g) Coordinating with any appropriate agency or fusion center.
- (h) Ensuring that, as resources are available, the Department conducts outreach that is designed to encourage members of the community to report suspicious activity and that outlines what they should look for and how they should report it (e.g., website, public service announcements).

434.4 REPORTING AND INVESTIGATION

Any department member receiving information regarding suspicious activity should take any necessary immediate and appropriate action, including a request for tactical response or immediate notification of specialized entities, when applicable. Any professional staff member who receives such information should ensure that it is passed on to an officer in a timely manner.

If the suspicious activity is not directly related to a reportable crime, the member should prepare a SAR and include information about involved parties and the circumstances of the incident. If, during any investigation, an officer becomes aware of suspicious activity that is unrelated to the current investigation, the information should be documented separately in a SAR and not included in the original incident report. The report number of the original incident should be included in the SAR as a cross reference. A SAR should be processed as any other incident report.

434.5 HANDLING INFORMATION

The Records Section will forward copies of SARs, in a timely manner, to the following:

- Detective Bureau supervisor
- Crime Analysis Unit
- Other authorized designees

Medical Aid and Response

435.1 PURPOSE AND SCOPE

This policy recognizes that members often encounter persons in need of medical aid and establishes a law enforcement response to such situations.

435.2 POLICY

It is the policy of the Culver City Police Department that all officers and other designated members be trained to provide emergency medical aid and to facilitate an emergency medical response.

435.3 FIRST RESPONDING MEMBER RESPONSIBILITIES

Whenever practicable, members should take appropriate steps to provide initial medical aid (e.g., first aid, CPR, use of an automated external defibrillator (AED)) in accordance with their training and current certification levels. This should be done for those in need of immediate care and only when the member can safely do so.

Prior to initiating medical aid, the member should contact Southbay RCC and request response by Emergency Medical Services (EMS) as the member deems appropriate.

Members should follow universal precautions when providing medical aid, such as wearing gloves and avoiding contact with bodily fluids, consistent with the Communicable Diseases Policy. Members should use a barrier or bag device to perform rescue breathing.

When requesting EMS, the member should provide Southbay RCC with information for relay to EMS personnel in order to enable an appropriate response, including:

- (a) The location where EMS is needed.
- (b) The nature of the incident.
- (c) Any known scene hazards.
- (d) Information on the person in need of EMS, such as:
 1. Signs and symptoms as observed by the member.
 2. Changes in apparent condition.
 3. Number of patients, sex, and age, if known.
 4. Whether the person is conscious, breathing, and alert, or is believed to have consumed drugs or alcohol.
 5. Whether the person is showing signs or symptoms of extreme agitation or is engaging in violent irrational behavior accompanied by profuse sweating, extraordinary strength beyond their physical characteristics, and imperviousness to pain.

Members should stabilize the scene whenever practicable while awaiting the arrival of EMS.

Members should not direct EMS personnel whether to transport the person for treatment.

Culver City Police Department

Culver City PD Policy Manual

Medical Aid and Response

435.4 TRANSPORTING ILL AND INJURED PERSONS

Except in exceptional cases where alternatives are not reasonably available, members should not transport persons who are not in custody and who are unconscious, who have serious injuries, or who may be seriously ill. EMS personnel should be called to handle patient transportation.

For guidelines regarding transporting ill or injured persons who are in custody, see the Transporting Persons in Custody Policy.

Members should not provide emergency escort for medical transport or civilian vehicles.

435.5 PERSONS REFUSING EMS CARE

If a person who is not in custody refuses EMS care or refuses to be transported to a medical facility, an officer shall not force that person to receive care or be transported. However, members may assist EMS personnel when EMS personnel determine the person lacks mental capacity to understand the consequences of refusing medical care or to make an informed decision and the lack of immediate medical attention may result in serious bodily injury or the death of the person.

In cases where mental illness may be a factor, the officer should consider proceeding with a 72-hour treatment and evaluation commitment (5150 commitment) process in accordance with the Mental Illness Commitments Policy.

If an officer believes that a person who is in custody requires EMS care and the person refuses, he/she should encourage the person to receive medical treatment. The officer may also consider contacting a family member to help persuade the person to agree to treatment or who may be able to authorize treatment for the person.

If the person who is in custody still refuses, the officer will require the person to be transported to the nearest medical facility. In such cases, the officer should consult with a supervisor prior to the transport.

Members shall not sign refusal-for-treatment forms or forms accepting financial responsibility for treatment.

435.6 MEDICAL ATTENTION RELATED TO USE OF FORCE

Specific guidelines for medical attention for injuries sustained from a use of force may be found in the Use of Force, Handcuffing and Restraints, Control Devices and Techniques, and Conducted Energy Device policies.

435.7 AIR AMBULANCE

Generally, when on-scene, EMS personnel will be responsible for determining whether an air ambulance response should be requested. An air ambulance may be appropriate when there are victims with life-threatening injuries or who require specialized treatment (e.g., gunshot wounds, burns, obstetrical cases), and distance or other known delays will affect the EMS response.

435.8 AUTOMATED EXTERNAL DEFIBRILLATOR (AED) USE

A member may use an AED only after receiving appropriate training from an approved public safety first aid and CPR course (22 CCR 100026.01; 22 CCR 100027.01; 22 CCR 100027.02).

Culver City Police Department

Culver City PD Policy Manual

Medical Aid and Response

435.8.1 AED USER RESPONSIBILITY

Members who are issued AEDs should check the AED at the beginning of the shift to ensure it is properly charged and functioning. Any AED that is not functioning properly shall be taken out of service and given to the Personnel and Training Lieutenant who is responsible for ensuring appropriate maintenance.

Following use of an AED, the device shall be cleaned and/or decontaminated as required. The electrodes and/or pads will be replaced as recommended by the AED manufacturer.

Any member who uses an AED should contact Southbay RCC as soon as possible and request response by EMS.

435.8.2 AED REPORTING

Any member using an AED will complete an incident report detailing its use.

435.8.3 AED TRAINING AND MAINTENANCE

The Personnel and Training Lieutenant should ensure appropriate training and refresher training is provided to members authorized to use an AED. A list of authorized members and training records shall be made available for inspection by the local EMS agency (LEMSA) or EMS authority upon request (22 CCR 100027.05; 22 CCR 100027.06; 22 CCR 100028.07).

The Personnel and Training Lieutenant is responsible for ensuring AED devices are appropriately maintained and will retain records of all maintenance in accordance with the established records retention schedule (22 CCR 100027.05).

435.9 ADMINISTRATION OF OPIOID OVERDOSE MEDICATION

Trained members may administer opioid overdose medication (Civil Code § 1714.22; Business and Professions Code § 4119.9).

The purpose of this policy is to establish uniform procedures for the administering of Naloxone Hydrochloride, the generic name for "Narcan." The purpose of this deployment is to equip department personnel with the ability to assist with the medical emergency of an opioid (i.e., Heroin, Fentanyl, Hydrocodone, Oxycodone, etc.) overdose.

435.9.1 OPIOID OVERDOSE MEDICATION USER RESPONSIBILITIES

Members who are qualified to administer opioid overdose medication, such as naloxone or Narcan nasal spray, should handle, store and administer the medication consistent with their training. Members should check the medication and associated administration equipment at the beginning of their shift to ensure they are serviceable and not expired. Any expired medication or unserviceable administration equipment should be removed from service and given to the Personnel and Training Section.

Any member who administers an opioid overdose medication should contact Communications as soon as possible and request response by EMS.

Culver City Police Department

Culver City PD Policy Manual

Medical Aid and Response

435.9.2 OPIOID OVERDOSE MEDICATION TRAINING

The Personnel and Training Lieutenant should ensure initial and refresher training is provided to members authorized to administer opioid overdose medication. Training should be coordinated with the local health department and comply with the requirements in 22 CCR 100027.03 and any applicable POST standards (Civil Code § 1714.22).

435.9.3 DESTRUCTION OF OPIOID OVERDOSE MEDICATION

The Personnel and Training Sergeant shall ensure the destruction of any expired opioid overdose medication (Business and Professions Code § 4119.9).

435.9.4 OPIOID OVERDOSE MEDICATION RECORD MANAGEMENT

Records regarding acquisition and disposition of opioid overdose medications shall be maintained and retained in accordance with the established records retention schedule and at a minimum of three years from the date the record was created (Business and Professions Code § 4119.9).

435.9.5 OPIOID OVERDOSE MEDICATION TRAINING

The Personnel and Training Sergeant should ensure initial and refresher training is provided to members authorized to administer opioid overdose medication. Training should be coordinated with the local health department and comply with the requirements in 22 CCR 100019 and any applicable POST standards (Civil Code § 1714.22).

435.9.6 PROCEDURES

Narcan Nasal Spray can be obtained from the Personnel and Training Lieutenant . The Personnel and Training Section shall develop a process for ensuring personnel from their Department obtain training and are issued the nasal spray.

Each Department member shall regularly check to ensure their issued Narcan Nasal Spray has not expired. An expired nasal spray shall be turned in to the Personnel and Training Section and replaced. All expired Narcan Nasal Spray will be booked into Property for destruction. It is recommended Department members keep their issued Narcan Nasal Spray stored in their Department Naloxone pouch. Care should be taken to ensure the applicators are not exposed to excessive heat or light to protect the potency of the nasal spray. Narcan Nasal Spray has a shelf life of approximately two years.

435.9.7 ADDITIONAL INFORMATION

Narcan Nasal Spray can be used on Department personnel who come in contact with an opioid-related drug in the course and scope of their duties and suffer the effects of an overdose while awaiting paramedics/fire to respond.

435.10 SICK OR INJURED ARRESTEE

If an arrestee appears ill or injured, or claims illness or injury, the arrestee should be medically cleared prior to booking. If the officer has reason to believe the arrestee is feigning injury or illness, the officer should contact a supervisor, who will determine whether medical clearance will be obtained prior to booking.

Culver City Police Department

Culver City PD Policy Manual

Medical Aid and Response

If the jail or detention facility refuses to accept custody of an arrestee based on medical screening, the officer should note the name of the facility person refusing to accept custody and the reason for refusal, and should notify a supervisor to determine the appropriate action.

Arrestees who appear to have a serious medical issue should be transported by ambulance to an appropriate medical facility.

Nothing in this section should delay an officer from requesting EMS when an arrestee reasonably appears to be exhibiting symptoms that appear to be life threatening, including breathing problems or an altered level of consciousness, or is claiming an illness or injury that reasonably warrants an EMS response in accordance with the officer's training.

435.10.1 HOSPITAL SECURITY AND CONTROL

Officers who transport persons in custody to medical facilities for treatment should provide security and control during examination and treatment consistent with department protocols. Any such transport should be conducted in accordance with the Transporting Persons in Custody Policy.

The Operations Bureau Commander should develop protocols related to the following:

- (a) Providing security and control during an examination or treatment, including:
 - 1. Monitoring the person in custody (e.g., guarding against escape, suicide, and assault of others)
 - 2. Removal of restraints, if necessary and appropriate (see the Handcuffing and Restraints Policy)
- (b) Responsibility for continuing security and control if the person in custody is admitted to the hospital
 - 1. This should include transferring custody of the person to an appropriate agency.

435.11 FIRST-AID TRAINING

The Personnel and Training Lieutenant should ensure officers receive initial first-aid training within one year of employment and refresher training every two years thereafter (22 CCR 100026.03; 22 CCR 100027.06).

Mobile and Body Audio Video System

436.1 PURPOSE AND SCOPE

The Culver City Police Department has equipped certain vehicles with Mobile Audio Video (MAV) recording systems and certain officers and other employees with Body Worn Cameras (BWC) for use while performing field duties. The MAV and BWC recording systems are integrated and will provide records of events and assist officers and employees in the performance of their duties. This policy provides guidance on the use of these systems (currently utilizing Axon products).

436.2 INTENDED USE

It is the intent of the Culver City Police Department to use MAV and BWC technology to more effectively fulfill the department's mission and to ensure these systems are used securely and efficiently.

The use of the MAV and BWC system is intended to accomplish the following:

- (a) Document events during contacts, arrests and critical incidents to clearly identify suspects and their vehicles.
- (b) Document events during citizen contacts and other enforcement actions, including but not limited to prisoner transport, issuance of parking citations and animal services investigations.
- (c) Record incidents for criminal and civil investigations, for mitigation of personnel complaints, for audit review, and training of department personnel.
- (d) Vividly replay those incidents for prosecutors and courts, thereby increasing rates of convictions for violations of the law.
- (e) Improve Departmental accountability, transparency, and preserve public trust.

436.3 DEFINITIONS

Activate and initiate– Synonymous terms that refer to any process that causes the MAV or BWC systems to transmit or store video or audio data in an active mode.

In-car camera system and Mobile Audio Video (MAV) system – Synonymous terms which refer to any system that captures audio and video signals, that is capable of installation in a vehicle, and that includes at minimum, a camera, microphone, recorder and monitor.

Body worn camera (BWC) – Any device that captures audio and video that is capable of being worn on an officer's or employee's person.

MAV and BWC technician (Computer Services Unit Personnel) – Personnel certified or trained in the operational use and repair of MAVs and BWCs, duplicating methods, storage and retrieval methods and procedures, and who have working knowledge of video forensics and evidentiary procedures.

Recorded media – Audio and video signals recorded or digitally stored on a storage device or portable media.

Culver City Police Department

Culver City PD Policy Manual

Mobile and Body Audio Video System

Officer- Any sworn member of this Department who utilizes the MAV and/or BWC.

Employee – Any department personnel assigned to field duties that may require the use of a MAV and/or BWC. This shall include but not be limited to police officers, Sergeants, Lieutenants, jailers, parking enforcement officers, community service officers, animal services officers, and any other person at the direction of department supervision.

436.4 EMPLOYEE RESPONSIBILITIES

Officers and employees who work uniformed assignments, in which the vehicle is a primary component of their duties, shall use vehicles equipped with MAV systems along with a BWC. All Officers and employees using vehicles equipped with MAV systems shall ensure they are accurately logged into the corresponding software. Employees assigned to uniform field assignments in which a vehicle is not a primary component of their duties (i.e. foot beat, bike patrol, motorcycle patrol, detectives involved in enforcement activity and or warrant service, etc.) shall wear and utilize a BWC.

All sworn patrol and traffic personnel will be issued a BWC. It is the employee's responsibility to ensure that the BWC is synced to their name and connected to both the MAV and Taser systems.

At the start of each shift, employees shall test the MAV and BWC systems to ensure that they are synchronized, capturing both audio and video data, and functioning in accordance with department operating procedures, training, and manufacturer specifications covering the following matters:

- (a) BWC
 1. Adequate power source
 2. Synchronized with the MAV and recording equipment (if applicable)
 3. Remote activation of MAV system via BWC
 4. Camera is mounted securely to the high center chest area of the uniform
- (b) MAV
 1. Windshield and camera lens are free of debris
 2. Camera facing intended direction
 3. System plays back both audio and video tracks

If a MAV or BWC system is malfunctioning, employees shall take the vehicle or BWC out of service and complete the appropriate repair request. In the event of a vehicle shortage, vehicles with an inoperable MAV system may remain in service with the approval of a supervisor. Uniformed employees driving vehicles with an inoperable MAV system who are assigned to a duty that may require enforcement activity are required to utilize a BWC.

Employees are also responsible for ensuring that each MAV and BWC recording is classified properly at the conclusion of an incident in which the MAV and/or BWC are utilized. This is addressed further below. At the conclusion of each shift, employees are responsible for ensuring that their assigned BWC has uploaded the captured video footage by placing the BWC in the

Culver City Police Department

Culver City PD Policy Manual

Mobile and Body Audio Video System

appropriate docking/charging station or ensuring that the footage has been uploaded via the cellular device function.

436.5 ACTIVATION OF THE MAV AND BWC

The MAV and BWC system is designed to activate under the following conditions:

- (a) When turned on manually
- (b) Whenever the unit's emergency lights are activated (if driving a vehicle)
- (c) If the vehicle travels in speeds in excess of 75 mph
- (d) When an Officer activates their Taser device

The system remains activated until it is turned off manually.

436.6 WHEN ACTIVATION IS NOT REQUIRED

Activation of the MAV and BWC system is not required when exchanging information with other employees or during breaks, lunch periods, when not in service, or actively on routine patrol.

Employees shall have the discretion to "mute" their BWC (audio only) when speaking:

- (a) with other employees, or supervisors about tactics for handling an incident
- (b) with a confidential informant
- (c) with a citizen or department personnel about something not related to the incident being recorded
- (d) about things protected under Evidence Code sections 1040 – 1042

Absent legal cause or lawful order, no member of this department may surreptitiously record any other member of this department without the expressed knowledge and consent of all parties.

Employees who mute their BWC during those incidents requiring recording without meeting the above-listed criteria for muting may be subject to discipline.

436.7 REQUIRED ACTIVATION OF MAV AND BWC

This policy is not intended to describe every possible situation in which the MAV and BWC system may be used. An officer or employee may activate the system any time the officer or employee believes it would be appropriate, or capture valuable evidence.

Absent good cause, the MAV and or BWC system shall be activated in any of the following situations:

- (a) All field contacts involving actual or potential criminal conduct within video or audio range including but not limited to:
 - 1. Traffic stops (to include, but not limited to, traffic violations, standard motorist assistance and all criminal interdiction stops)
 - 2. Priority responses to radio calls
 - 3. Vehicle pursuits

Culver City Police Department

Culver City PD Policy Manual

Mobile and Body Audio Video System

4. Suspicious vehicles
5. Arrests
6. The placement of any person in the backseat of a police unit.
 - (a) This shall include but not be limited to:
 - Detained subjects
 - Arrested subjects prior to transport
 - People in protective custody
 - People participating in field show-ups or other investigation-related activities
 - (b) The backseat camera shall be activated prior to placing someone in the backseat, or as soon as practical.
7. Prisoner transport (prisoner camera must be manually activated)
8. Parking enforcement actions, investigations, and related citizen contacts
9. Animal services-related contacts and/or investigations.
10. Vehicle searches
11. Physical or verbal confrontations or use of force incidents
12. Pedestrian checks
13. DWI/DUI investigations including field sobriety tests
14. Consensual encounters
15. In-progress crimes/calls
- (b) Any call for service involving a crime where the MAV and BWC system may aid in the apprehension and/or prosecution of a suspect:
 1. Domestic violence
 2. Disturbance of peace calls
 3. Offenses involving violence or weapons
- (c) Any other contact or self-initiated activity that becomes adversarial after the initial contact in a situation that would not otherwise require recording.
- (d) Any other circumstance where the officer believes that a recording of an incident would be appropriate.
- (e) Officers and employees have the option of utilizing their BWC without their MAV when responding to non-priority calls for service that will take them a significant distance from their vehicles.

Officers assigned to motorcycle patrol should never sacrifice the safe operation of their motorcycle in order to activate their BWC. Officers assigned to motorcycle patrol duties are required to activate their BWC in accordance with this policy when reasonably safe to do so; i.e. when stepping off

Culver City Police Department

Culver City PD Policy Manual

Mobile and Body Audio Video System

their motorcycle after conducting a traffic stop, when they are parked or stationary, or after arriving at a call for service.

436.8 CESSATION OF RECORDINGS

Absent good cause, once activated, the MAV and BWC system shall remain on until the incident has concluded. For purposes of this section, conclusion of an incident has occurred when all arrests have been made, arrestees have been transported and all witnesses and victims have been interviewed. Recording may cease if an employee is simply waiting for a tow truck or a family member to arrive, or in other similar situations. Officers may choose to deactivate their MAV and utilize only their BWC after arriving at a priority call that will take them a significant distance from their vehicle.

436.8.1 PROCEDURES

- (a) Unauthorized use, duplication, and/or distribution of MAV and or BWC files is prohibited. Personnel shall not make copies of any MAV or BWC file for their personal use and are prohibited from using a recording device such as a cellphone camera or secondary video camera to record MAV and or BWC files.
- (b) The MAV and or BWC shall not be used to record non work related activity and shall not be activated in places where a reasonable expectation of privacy exists, such as locker rooms, dressing rooms, or restrooms.
- (c) Employees should be aware of their surroundings when operating the BWC, such as in a hospital emergency room where privacy of patients should be considered when operating the BWC. Employees should consider deactivating their BWC when inside an emergency room and the situation does not require activation under this policy. Employees should also consider deactivating their MAV and or BWC when in the presence of emergency medical personnel who are treating patients at the scene of a medical emergency or inside an ambulance and the situation does not require activation under this policy.
- (d) When utilizing the MAV and or BWC, employees shall be sensitive to the dignity of all individuals being recorded. Employees are to utilize sound judgment and exercise discretion when the respect for privacy indicates that discontinuing audio and video recording is prudent because it reasonably appears to the employee that such privacy may outweigh any legitimate law enforcement interest in the recording. Unless the circumstances no longer fit the criteria for recording under this policy, recording should resume when privacy is no longer at issue.
- (e) Personnel shall only use the MAV and or BWC systems issued and approved by the Department for official police duties. The utilization and or wearing of any other personal video recorder while on duty is not authorized without permission of the Chief of Police.
- (f) Personnel shall not remove, dismantle or tamper with any hardware and or software component or part of the MAV and or BWC.
- (g) Employees shall cease video audio recording whenever necessary to ensure conversations are not recorded between a person in custody and the person's

Culver City Police Department

Culver City PD Policy Manual

Mobile and Body Audio Video System

attorney, religious advisor or physician, unless there is explicit consent from all parties to the conversation (Penal Code § 636).

- (h) Strip searches shall not be recorded; it shall be a violation of this policy to audio or video record any strip search.
- (i) When it is reasonably safe to do so, employees should make every effort to cover nude subjects when utilizing the MAV or BWC.
- (j) Requests by members of the public to stop recording should be considered using the activation criteria described in this policy. If the employee believes the contact remains consistent with the activation criteria, the employee shall continue to record the contact.
- (k) At no time is an employee expected to jeopardize his or her safety in order to activate or deactivate their MAV and or BWC. However, the MAV and or BWC should be activated in situations described in this policy as soon as practical.
- (l) After the initial response to the call-for-service and activation of the MAV and or BWC is no longer required under this policy, officers should consider deactivating their MAV and or BWC when interviewing a minor or the victim of a sexual assault.
- (m) Excluding motor officers utilizing the helmet-mounted BWC attachment, the BWC shall be secured to the center chest area of the employee's uniform utilizing either a Department issued BWC clip or magnet.

436.9 SUPERVISOR RESPONSIBILITIES

At reasonable intervals, supervisors should validate that recording procedures are followed.

When an incident arises that requires the immediate retrieval of the recorded media (e.g., serious crime scenes, officer-involved shootings, department-involved collisions), a supervisor shall respond to the scene and ensure that a MAV and BWC technician or crime scene investigator properly retrieves the recorded media. The media may need to be treated as evidence and should be handled in accordance with current evidence procedures for recorded media.

Minor infractions (not criminal in nature) committed by any member of the Culver City Police Department and discovered during routine review of recorded material should be viewed as training opportunities and not as routine disciplinary actions. Should the behavior or action become habitual after being addressed, the appropriate disciplinary or corrective action shall be taken.

Supervisors should determine if vehicles with non-functioning MAV systems should be placed into service. If these vehicles are placed into service, the appropriate documentation (supervisor's/ watch commander's log) and notifications should be made.

Supervisors who are informed or otherwise become aware of a malfunctioning MAV or BWC shall ensure that authorized personnel make repairs in a timely manner.

Culver City Police Department

Culver City PD Policy Manual

Mobile and Body Audio Video System

436.10 SUPERVISOR USE OF LIVE FEED FEATURE

The BWC and MAV systems have the capability of allowing for live, real-time viewing of the BWC, in-car audio, and video feed, which can be accessed by certain computer terminals throughout the Culver City Police Department.

Unless prior notice is given to the officers (see below), the live feed feature shall only be utilized by supervisors (sergeants or above) during emergency field operations. No prior notice need be given to officers before accessing the live feed feature in an emergency situation. Examples of acceptable emergency situations include but are not limited to:

- (a) Vehicle pursuits
- (b) Foot pursuits
- (c) Officer involved shootings
- (d) Officer requesting emergency assistance
- (e) Felony or high-risk traffic stops
- (f) Officer involved traffic accidents
- (g) Officer unaccounted for and not answering the radio (after all other resources have been exhausted, ie. phone call)

In all instances where a supervisor intends to use the live feed feature of the BWC or vehicle's MAV system in a non-emergency situation, the supervisor shall make every effort to notify the officers working in that unit prior to accessing the live feed. The live feed feature of the BWC and MAV system shall not be used for retaliation. Any supervisor that misuses the live feed feature of the BWC or MAV system is subject to discipline under this policy.

436.11 REVIEW AND RELEASE OF MAV AND BWC RECORDINGS

MAV and BWC recordings are generally not disclosable as public records. All recording media, recorded images and audio recordings are the property of the Culver City Police Department; dissemination outside of the agency is strictly prohibited, except to the extent required by law. The Chief of Police has the discretion to allow viewing or release of recorded files if the Chief determines it is in the best interest of the Police Department or the City of Culver City. When appropriate, every effort will be made to notify involved employees prior to release.

To prevent damage to or alteration of the original recorded media, it shall not be copied, viewed or otherwise inserted into any device not approved by the department MAV and BWC technician. When reasonably possible, a copy of the original media shall be used for viewing (unless otherwise directed by the courts) to preserve the original media.

Recordings may be reviewed in any of the following situations:

- (a) For use when preparing reports or statements.
- (b) By a supervisor investigating a specific act of employee conduct.
- (c) To assess proper functioning of MAV and BWC systems.

Culver City Police Department

Culver City PD Policy Manual

Mobile and Body Audio Video System

- (d) To assess possible training value
- (e) Recordings may be reviewed and shown for training purposes. If an involved employee objects to showing a recording, the recording will not be shown to other employees. The recording may, however, be viewed by supervisors for training and performance assessment purposes.
- (f) By department investigators who are participating in an official investigation, such as a personnel complaint, administrative inquiry or a criminal investigation.
- (g) By any employee captured on or referenced in the video or audio data, who reviews and uses such data to help ensure accuracy and consistency of accounts.
- (h) Pursuant to a lawful subpoena or by court personnel through proper processes or with permission of the Chief of Police or the Chief's authorized designee.
- (i) Subject to the provisions of this policy, the Chief of Police has the discretion to prohibit the review of any recordings by Department employees if it is determined it is in the best interest of the Police Department or the City of Culver City.
- (j) Subject to the provisions of (f) above, in the event that an employee is to be interviewed pursuant to an investigation related to an incident which results in injury, bodily harm, death or involves the use of force, the employee and/or his/her attorney will be afforded an opportunity to review his/her video of the incident prior to the interview, or after the employee has been interviewed, by the appropriate investigative personnel. If the employee elects to view the video after being interviewed, the employee shall be afforded the opportunity to review the video immediately after providing his/her statement regarding the underlying incident and be given an opportunity to offer a supplemental statement. Prior to the employee offering an initial statement, the following admonishment should be provided to the employee:
 1. "In this case, there is video evidence that you have had (or will have) an opportunity to view before (after) giving your initial statement. Video evidence has limitations and may depict the events differently than you recall, and may not depict all of the events as seen or heard by you. Video has a limited field of view and may not capture events normally seen by the human eye. Lighting as seen in the video may be different than what is seen by the human eye. Videos are a two-dimensional medium and may not capture depth, distance or positional orientation as well as the human eye. Remember, the video evidence is intended to assist your memory and ensure that your initial statement explains your state of mind at the time of the incident."

Employees desiring to view any previously uploaded or archived MAV and or BWC recording that they would not typically have access to should submit a request in writing to a supervisor.

In no event shall any recording be used or shown for the purpose of ridiculing or embarrassing any employee.

436.12 DOCUMENTING MAV AND BWC USE

If any incident is recorded with the MAV and BWC system, the existence of that recording shall be documented in the employee's report. If a citation is issued, the officer or employee shall make a

Culver City Police Department

Culver City PD Policy Manual

Mobile and Body Audio Video System

notation on the back of the records copy of the citation, indicating that the incident was recorded. Employees who reasonably believe that a MAV and or BWC recording is likely to contain evidence relevant to a criminal offense or potential claim against the employee or against the Culver City Police Department should indicate this in an appropriate report. Employees should ensure relevant recordings are preserved in accordance with the Department's retention schedule.

436.13 RECORDING MEDIA STORAGE, RETENTION AND INTEGRITY

In general, all recordings should be retained for two (2) years unless they are identified as evidence. If a recording is identified as evidence the retention will follow the Evidence/Property Files retention schedule. Recordings which become part of a citizen complaint or administrative/internal investigation will follow the retention time identified for the complaint/investigation. Inadvertent/accidental recordings of personal events and conversations shall be purged as soon as practicable upon the approval of a Bureau Commander. Once submitted for evidence storage, all recording media will be labeled and stored in a designated secure area in accordance with proper evidence procedures. Anyone with the authorization to do so may increase the retention time for recordings when it is believed that retaining said recordings for a longer period of time would be in the best interest of the Department or the City.

436.14 CLASSIFICATION OF RECORDINGS

As stated above in this policy, employees shall classify each recording at the conclusion of an incident in which the MAV and or BWC is utilized. Employees should use the classification that best fits the incident in which the MAV and or BWC was utilized. "Retain" is the system's default classification setting. Below is a list of available classifications:

1. **"Retain"**- All calls for service, enforcement stops, arrest situations, transportation, search warrants, etc.
2. **"System Test"**- Only used after testing the working condition of the MAV and BWC.
3. **"PSU Indefinite"** - Retains footage indefinitely.
4. **"False Signal"** - Only used after false activation from Signal device(s)

436.15 COPIES OF ORIGINAL RECORDING MEDIA

Audio or video (media) from the MAV and BWC system shall not be copied, exported, or recorded in any way for any purpose other than for circumstances authorized in this policy.

Media from the MAV and BWC system may only be released in response to a court order or upon approval by the Chief of Police or an authorized designee. All media shall be reviewed by the Technical Support Supervisor (or another supervisor if the Technical Support Supervisor is not available) prior to its release. Anything of a personal or confidential nature included in the media should be evaluated by the appropriate personnel, and redacted if deemed appropriate. All redactions shall be approved by a Bureau Commander. An original copy of the media shall be retained by the Department.

Culver City Police Department

Culver City PD Policy Manual

Mobile and Body Audio Video System

436.16 SYSTEM OPERATIONAL STANDARDS

- (a) MAV and BWC system vehicle installations should be based on employee safety requirements and the vehicle and device manufacturer's recommendations.
- (b) The MAV and BWC system shall be configured to record (video only) 30 seconds prior to an event.
- (c) The MAV and BWC system shall not be configured to record audio data occurring prior to activation.
- (d) The MAV and BWC system shall be configured to record audio and video using the above-described automatic triggers, and upon manual activation by the employee
- (e) Employees shall not erase, alter, reuse, modify or tamper with MAV and or BWC recordings.
- (f) Only a supervisor, MAV and BWC technician or other authorized designee may erase and reissue previous recordings and may only do so pursuant to the provisions of this policy.
- (g) To prevent damage, original recordings shall not be viewed on any equipment other than the equipment issued or authorized by the MAV and BWC technician.

436.17 MAV AND BWC TECHNICIAN RESPONSIBILITIES

The MAV and BWC technician is responsible for:

- (a) Ordering, issuing, retrieving, storing, erasing and duplicating of all recorded media.
- (b) Collecting all completed media for oversight and verification of wireless downloaded media. Once collected, the MAV and BWC technician should ensure it is stored in a secure location with authorized controlled access.
- (c) Erasing of media:
 - 1. Pursuant to a court order.
 - 2. In accordance with established records retention policies, including reissuing all other media deemed to be of no evidentiary value.
- (d) Ensuring that an adequate supply of recording media is available.
- (e) Managing the long-term storage of media that has been deemed to be of evidentiary value in accordance with the department evidence storage protocols and the records retention schedule.

436.18 TRAINING

All members who are authorized to use the MAV and BWC system shall receive training prior to its use. All officers that are hired after the implementation of the MAV and BWC system shall receive MAV and BWC system training as part of their field training program.

Aircraft Accidents

437.1 PURPOSE AND SCOPE

The purpose of this policy is to provide department members with guidelines for handling aircraft accidents.

This policy does not supersede, and is supplementary to, applicable portions of the Crime and Disaster Scene Integrity, Emergency Management Plan and Hazardous Material Response policies.

437.1.1 DEFINITIONS

Definitions related to this policy include:

Aircraft - Any fixed wing aircraft, rotorcraft, balloon, blimp/dirigible or glider that is capable of carrying a person or any unmanned aerial vehicle other than those intended for non-commercial recreational use.

437.2 POLICY

It is the policy of the Culver City Police Department to provide an appropriate emergency response to aircraft accidents. This includes emergency medical care and scene management.

437.3 ARRIVAL AT SCENE

Officers or other authorized members tasked with initial scene management should establish an inner and outer perimeter to:

- (a) Protect persons and property.
- (b) Prevent any disturbance or further damage to the wreckage or debris, except to preserve life or rescue the injured.
- (c) Preserve ground scars and marks made by the aircraft.
- (d) Manage the admission and access of public safety and medical personnel to the extent necessary to preserve life or to stabilize hazardous materials.
- (e) Maintain a record of persons who enter the accident site.
- (f) Consider implementation of an Incident Command System (ICS).

437.4 INJURIES AND CASUALTIES

Members should address emergency medical issues and provide care as a first priority.

Those tasked with the supervision of the scene should coordinate with the National Transportation Safety Board (NTSB) before the removal of bodies. If that is not possible, the scene supervisor should ensure documentation of what was disturbed, including switch/control positions and instrument/gauge readings.

Culver City Police Department

Culver City PD Policy Manual

Aircraft Accidents

437.5 NOTIFICATIONS

When an aircraft accident is reported to this department, the responding supervisor shall ensure notification is or has been made to NTSB, the Federal Aviation Administration (FAA), and when applicable, the appropriate branch of the military.

Supervisors shall ensure other notifications are made once an aircraft accident has been reported. The notifications will vary depending on the type of accident, extent of injuries or damage, and the type of aircraft involved. When an aircraft accident has occurred, it is generally necessary to notify the following:

- (a) Fire department
- (b) Appropriate airport tower
- (c) Emergency medical services (EMS)

437.6 CONTROLLING ACCESS AND SCENE AUTHORITY

Prior to NTSB arrival, scene access should be limited to authorized personnel from the:

- (a) FAA.
- (b) Fire department, EMS or other assisting law enforcement agencies.
- (c) Coroner.
- (d) Air Carrier/Operators investigative teams with NTSB approval.
- (e) Appropriate branch of the military, when applicable.
- (f) Other emergency services agencies (e.g., hazardous materials teams, biohazard decontamination teams, fuel recovery specialists, explosive ordnance disposal specialists).

The NTSB has primary responsibility for investigating accidents involving civil aircraft. In the case of a military aircraft accident, the appropriate branch of the military will have primary investigation responsibility.

After the NTSB or military representative arrives on-scene, the efforts of this department will shift to a support role for those agencies.

If NTSB or a military representative determines that an aircraft or accident does not qualify under its jurisdiction, the on-scene department supervisor should ensure the accident is still appropriately investigated and documented.

437.7 DANGEROUS MATERIALS

Members should be aware of potentially dangerous materials that might be present. These may include, but are not limited to:

- (a) Fuel, chemicals, explosives, biological or radioactive materials and bombs or other ordnance.
- (b) Pressure vessels, compressed gas bottles, accumulators and tires.
- (c) Fluids, batteries, flares and igniters.

Culver City Police Department

Culver City PD Policy Manual

Aircraft Accidents

- (d) Evacuation chutes, ballistic parachute systems and composite materials.

437.8 DOCUMENTATION

All aircraft accidents occurring within the City of Culver City shall be documented. At a minimum the documentation should include the date, time and location of the incident; any witness statements, if taken; the names of CCPD members deployed to assist; other City resources that were utilized; and cross reference information to other investigating agencies. Suspected criminal activity should be documented on the appropriate crime report.

437.8.1 WRECKAGE

When reasonably safe, members should:

- (a) Obtain the aircraft registration number (N number) and note the type of aircraft.
- (b) Attempt to ascertain the number of casualties.
- (c) Obtain photographs or video of the overall wreckage, including the cockpit and damage, starting at the initial point of impact, if possible, and any ground scars or marks made by the aircraft.
 - 1. Military aircraft may contain classified equipment and therefore shall not be photographed unless authorized by a military commanding officer (18 USC § 795).
- (d) Secure, if requested by the lead authority, any electronic data or video recorders from the aircraft that became dislodged or cell phones or other recording devices that are part of the wreckage.
- (e) Acquire copies of any recordings from security cameras that may have captured the incident.

437.8.2 WITNESSES

Members tasked with contacting witnesses should obtain:

- (a) The location of the witness at the time of his/her observation relative to the accident site.
- (b) A detailed description of what was observed or heard.
- (c) Any photographs or recordings of the accident witnesses may be willing to voluntarily surrender.
- (d) The names of all persons reporting the accident, even if not yet interviewed.
- (e) Any audio recordings of reports to 9-1-1 regarding the accident and dispatch records.

437.9 MEDIA RELATIONS

The Public Information Officer (PIO) should coordinate a response to the media, including access issues, road closures, detours and any safety information that is pertinent to the surrounding community. Any release of information regarding details of the accident itself should be coordinated with the NTSB or other authority who may have assumed responsibility for the investigation.

Culver City Police Department

Culver City PD Policy Manual

Aircraft Accidents

Depending on the type of aircraft, the airline or the military may be responsible for family notifications and the release of victims' names. The PIO should coordinate with other involved entities before the release of information.

Immigration

438.1 PURPOSE AND SCOPE

The purpose of this policy is to provide guidelines to members of the Culver City Police Department, sworn and non-sworn, relating to immigration and interacting with federal immigration officials.

438.2 POLICY

It is the policy of the Culver City Police Department that all members make personal and professional commitments to equal enforcement of the law and equal service to the public. Confidence in this commitment will increase the effectiveness of this department in protecting and serving the entire community and recognizing the dignity of all persons, regardless of their actual or perceived race, ethnicity, national origin, religion, color, sexual orientation/ identification, gender, gender identity, marital status, age, disability, political affiliation, or immigration status.

Except as otherwise specified below, it is the policy of the Culver City Police Department not to assist in the enforcement of federal immigration law. (Res. No. 2017-R025 § 3(1))

438.3 VICTIMS AND WITNESSES

To encourage crime reporting and cooperation in the investigation of criminal activity, all individuals, regardless of their immigration status, must feel as secure as possible that contacting or being addressed by members of law enforcement will not lead to immigration inquiry and/ or deportation. While it may be necessary to determine the identity of a victim or witness, members shall treat all individuals equally and without regard to actual or perceived race, ethnicity, national origin, religion, color, sexual orientation/ identification, gender, gender identity, marital status, age, disability, political affiliation, or immigration status in any way that would violate the United States or California constitutions.

438.4 IMMIGRATION INQUIRIES PROHIBITED

Officers shall not inquire into an individual's immigration status for any purpose not specifically authorized under this policy and, if authorized, only to the extent necessary to achieve that purpose. (Government Code § 7284.6; Res. No. 2017-R025 § 2(5)).

Because place of birth may be perceived or used as a proxy for immigration status, inquiries into place of birth are permitted only as follows. With regard to an individual who is subject to arrest, such inquiries are permitted where necessary for law enforcement purposes unrelated to immigration enforcement. With regard to an individual who is interviewed voluntarily (including as a potential witness or victim), or who is temporarily detained but not under arrest, officers should not ask for or record his or her place of birth.

Officers may inquire into an individual's immigration status only in circumstances involving qualifying that individual for a U-Visa or T-Visa (8 USC § 1101(a) (15) (T) & (U)), as well as for the purposes of extending appropriate privileges and immunities to foreign diplomatic and consular representatives, in accordance with international law.

Culver City Police Department

Culver City PD Policy Manual

Immigration

438.4.1 CALIFORNIA DEPARTMENT OF MOTOR VEHICLES

Members shall not obtain, access, use, or otherwise disclose noncriminal history information maintained by the DMV for immigration enforcement (Vehicle Code § 1808.48).

438.5 DETENTIONS FOR IMMIGRATION VIOLATIONS

An officer shall not detain any individual, for any length of time, for a civil violation of federal immigration laws, nor based on an immigration-related civil or administrative warrant or detainer (Government Code § 7284.6; (Res. No. 2017-R025 § 2(9)). An officer shall not detain any individual, for any length of time, on the basis of an actual or perceived criminal violation of federal immigration laws, absent a federal judicial warrant (Government Code § 7284.6).

438.5.1 DETENTIONS OR INVESTIGATIONS FOR NON-IMMIGRATION CRIMES

An officer shall not investigate or surveil an individual with respect to non-immigration crimes on the basis, in whole or in part, of such individual's actual or perceived immigration status (Res. No. 2017-R025 § 2(7)). When exercising reasonable discretion whether to detain, interrogate, or arrest an individual for a non-immigration crime, including whether to cite and release an individual with a notice to appear, officers shall make such decisions based on public safety considerations and not, in whole or in part, on an individual's actual or perceived immigration status (Res. No. 2017-R025 § 2(7), 3(3)).

When exercising such reasonable discretion, an officer shall accept a valid California AB60 driver's license, a federal non-compliant driver's license, as well as a Consular Card, as identification to the same extent, without discrimination, as any other valid California driver's license (Vehicle Code 12801.9).

438.5.2 EMERGENCY CARE FOR CHILDREN FOUND IN PRESENCE OF ARRESTED/ DETAINED INDIVIDUALS

Absent evidence of the child involved in commission of the crime suspected, child abuse, neglect or immediate danger to the child, an officer shall afford opportunity for a detained individual whose child is found in their presence and detained to call a family member, appropriate caregiver or close family friend to transfer care of said child to the family member, caregiver or close family friend prior to contacting the Department of Children and Family Services. Such opportunity should be afforded to the detained individual upon arrest, and should not be unreasonably delayed after detention. Communication of, or inquiries into, information related to the immigration status of the child, family member, guardian, care giver, or close family friend who may take custody of the child for purposes of immigration enforcement to the federal authorities shall follow the same prohibitions provided for in the instance of victims or witnesses in this policy.

438.6 FEDERAL REQUESTS FOR ASSISTANCE AND JOINT OPERATIONS

Department members shall not assist federal immigration officials nor grant any requests for such assistance unless specifically authorized by a supervisor. Such authorization by a supervisor is permitted only if such assistance is mandatory under federal or state law or is contractually obliged. This prohibition includes all assistance with or participation in any immigration enforcement operation or joint operation or patrol that involves, in whole or in part, enforcement of federal

Culver City Police Department

Culver City PD Policy Manual

Immigration

immigration law, except where, and limited to the extent that, Culver City Police Department involvement is necessary to protect public safety during a federal operation. It should be noted, for the purposes of this policy, actions to preserve public safety shall not include immigration enforcement actions.

(Government Code § 7284.2 et seq.; Res. No. 2017-R025 § 3(1)). In the event that any assistance provided to federal immigration authorities is authorized under this section, the Culver City Police Department shall notify the City Council as soon as possible.

438.7 INFORMATION SHARING & NOTIFICATIONS

Except as specified below, or absent a judicial warrant, court order, or subpoena, members of this department shall not release to federal immigration authorities any personal information of any sort, nor any information that may be used to locate any individual, unless for a law enforcement purpose unrelated to civil or criminal immigration law. Such information also may not be shared with any other person or agency with either the purpose or the reasonable likelihood that such person or agency will share such information with federal immigration authorities, unless for a law enforcement purpose unrelated to immigration law. (Government Code § 7284.6; Res. No. 2017-R025 § 2(6)).

Notwithstanding the above, no member of this department will prohibit, or in any way restrict, any other member of the department from doing any of the following regarding the citizenship or immigration status, lawful or unlawful, of any individual, in accordance with (8 USC § 1373; Government Code § 7284.6 (e)):

- (a) Sending information to, or requesting or receiving such information from federal immigration officials;
- (b) Maintaining such information in department records;
- (c) Exchanging such information with any other federal, state or local government entity.

438.8 NOTICE TO INDIVIDUALS

Individuals in custody shall be given a copy of documentation received from U.S. Immigration and Customs Enforcement (ICE) regarding a hold, notification or transfer request along with information as to whether the Culver City Police Department intends to comply with the request (Government Code § 7283.1). Individuals in custody may request and be afforded translation of said documentation.

If the Culver City Police Department provides ICE with notification that an individual is being, or will be, released on a certain date, the same notification shall be provided in writing to the individual and to his/her attorney or to one additional person who the individual may designate (Government Code § 7283.1). Individuals in custody may request and be afforded translation of said documentation.

Culver City Police Department

Culver City PD Policy Manual

Immigration

438.9 ACCESS TO DETAINED INDIVIDUALS OR CCPD FACILITIES

Department members shall not grant federal immigration officials access to any person in custody, or to any nonpublic area of Department facilities, unless specifically authorized by a supervisor. Such authorization by a supervisor is permitted only if such access is mandated by a court order or is necessary for law enforcement purposes unrelated to immigration enforcement. (Res. No. 2017-R025 § 2(3)). In the event that any federal immigration official is provided access under this section, the Culver City Police Department shall notify the City Council as soon as possible. In the event that any federal immigration official is provided access under this section, the department shall ensure that they are clearly identified as federal immigration agents (Res. No. 2017-R025 § 2(4)).

Before any interview regarding civil immigration violations takes place between ICE personnel and an individual in custody, the Culver City Police Department shall provide the individual with a written consent form that explains the purpose of the interview, that the interview is voluntary and that he/she may decline to be interviewed or may choose to be interviewed only with his/her attorney present. The consent form must be available in the languages specified in Government Code § 7283.1.

438.10 TRANSFERS TO IMMIGRATION AUTHORITIES

Department members shall not transfer an individual to federal immigration authorities unless specifically authorized by a supervisor. Such authorization by a supervisor is permitted only if the individual is identified by the U.S. Department of Homeland Security's Immigration and Customs Enforcement as the subject of an outstanding federal felony arrest warrant (Govt. Code § 7284.6(a)(4); Res. No. 2017-R025§ 2(2), (3), 3(1)).

In the event that any transfer to federal immigration officials is authorized under this section, the Culver City Police Department shall notify the City Council as soon as possible.

438.11 INTERMEDIARIES

Department member shall not take actions that allow this policy to be circumvented by enabling other persons or agencies, including other law enforcement agencies, to engage in conduct that would be prohibited under this policy if undertaken by members of this department. This includes, but is not limited to, sharing information that a department member reasonably expects will then be shared with federal immigration officials or transferring custody to an agency that will then transfer custody to federal immigration officials. Nothing in this section shall prohibit cooperation with other persons or agencies for purposes unrelated to immigration enforcement. Where reasonably feasible, the department shall take steps to limit the terms of such cooperation so as to prevent other agencies from using such cooperation to assist federal immigration officials.

438.12 U-VISA AND T-VISA NONIMMIGRANT STATUS

Under certain circumstances, federal law allows temporary immigration benefits, known as a U Visa, to victims and witnesses of certain qualifying crimes (8 USC § 1101(a)(15)(U)).

Culver City Police Department

Culver City PD Policy Manual

Immigration

Similar immigration protection, known as a T visa, is available for certain qualifying victims of human trafficking (8 USC § 1101(a)(15)(T)).

Any request for assistance in applying for U visa or T visa status should be forwarded in a timely manner to the Community Services Bureau Commander assigned to oversee the handling of any related case. The Community Services Bureau Commander should:

(a) Consult with the assigned investigator to determine the current status of any related case and whether further documentation is warranted.

(b) Contact the appropriate prosecutor assigned to the case, if applicable, to ensure the certification or declaration has not already been completed and whether a certification or declaration is warranted.

(c) Address the request and complete the certification or declaration, if appropriate, in a timely manner.

1. The instructions for completing certification and declaration forms can be found on the U.S. Department of Homeland Security (DHS) website.

2. Form I-918 Supplement B certification shall be completed if the victim qualifies under Penal Code § 679.10 (multiple serious offenses). Form I-914

Supplement B certification shall be completed if the victim qualifies under Penal Code § 236.5 or Penal Code § 679.11 (human trafficking).

(d) Ensure that any decision to complete, or not complete, a certification or declaration form is documented in the case file and forwarded to the appropriate prosecutor. Include a copy of any completed form in the case file.

(e) Inform the victim liaison of any requests and their status.

438.13 TIME FRAMES FOR COMPLETION

Officers and their supervisors who are assigned to investigate a case of human trafficking as defined by Penal Code § 236.1 shall complete the above process and the documents needed for indicating the individual is a victim for the T visa application within 15 business days of the first encounter with the victim, regardless of whether it is requested by the victim (Penal Code § 236.5).

Officers and their supervisors shall complete the above process and the documents needed certifying victim cooperation for a U visa or T visa application pursuant to Penal Code § 679.10 and Penal Code § 679.11 within 90 days of a request from the victim or victim's family related to one of their assigned cases. If the victim is in removal proceedings, the certification shall be processed within 14 days of the request.

438.14 REPORTING TO LEGISLATURE

The Community Services Bureau Commander or the authorized designee should ensure that certification requests are reported to the Legislature in January of each year and include the

Culver City Police Department

Culver City PD Policy Manual

Immigration

number of certifications signed and the number denied. The report shall comply with Government Code § 9795 (Penal Code § 679.10; Penal Code § 679.11).

438.15 TRAINING

The Training Manager shall ensure that all appropriate members receive training on immigration issues.

Training should include:

- (a) Identifying civil versus criminal immigration violations.
- (b) Identifying judicial warrants versus civil or administrative warrants, immigration detainers, and orders of removal.
- (c) Trainings should include the contents of this policy, as well as the Trust Act, Truth Act, and California Values Act (Government Code § 7282-7284.12 et seq.), the Culver City Sanctuary City Resolution (Res. No. 2017-R025), and AB60 (Vehicle Code § 12801.9).
- (d) Handling of mixed status families held in custody.

Emergency Response Unit

439.1 PURPOSE AND SCOPE

The Emergency Response Unit (ERU) is comprised of two specialized teams: the Crisis Negotiation Team (CNT) and the Emergency Response Team (ERT). The unit has been established to provide specialized support in handling critical field operations where intense negotiations and/or special tactical deployment methods beyond the capacity of field officers appear to be necessary. This policy is written to comply with the guidelines established in the Attorney General's Commission on Special Weapons and Tactics Report (September 2002) and the POST 2005 SWAT Operational Guidelines and Standardized Training Recommendations (Penal Code 13514.1).

439.1.1 OPERATIONAL AND ADMINISTRATIVE POLICY

The Policy Manual sections pertaining to the Emergency Response Unit include an Administrative and Operational Policy and Procedures. Since situations that necessitate the need for such a police response vary greatly from incident to incident and such events often demand on-the-scene evaluation, the Operational Policy outlined in this manual section serves as a guideline to department personnel allowing for appropriate on scene decision making as required. The Administrative Procedures, however, are more restrictive and few exceptions should be taken.

439.1.2 ERT DEFINED

The Emergency Response Team is a designated unit of law enforcement officers that is specifically trained and equipped to work as a coordinated team to resolve critical incidents that are so hazardous, complex, or unusual that they may exceed the capabilities of first responders or investigative units including, but not limited to, hostage taking, barricaded suspects, snipers, terrorist acts and other high-risk incidents. As a matter of department policy, such a unit may also be used to serve high-risk warrants, both search and arrest, where public and officer safety issues warrant the use of such a unit.

439.2 LEVELS OF CAPABILITY/TRAINING

439.2.1 TACTICAL RESPONSE TEAM

A Tactical Response Team is capable of conducting any single or combination of barricaded subject operations, sniper operations, high risk warrant service, high risk apprehensions, high risk security operations, and terrorism response operations. National Tactical Officers Association (NTOA) guidelines identify a Tactical Response Team as consisting of 15 members, and includes 1 Team Commander, 2 Team Leaders, and a minimum of 12 Operators.

439.3 POLICY

It shall be the policy of this department to maintain an Emergency Response Team to provide the equipment, manpower, and training necessary to maintain the ERT. The ERT should develop sufficient resources to perform three basic operational functions:

- (a) Rescue/Entry/Apprehension/

Culver City Police Department

Culver City PD Policy Manual

Emergency Response Unit

- (b) Command and Control
- (c) Containment

It is understood it is difficult to categorize specific capabilities for critical incidents. Training needs may vary based on the experience level of the team personnel, team administrators and potential incident commanders. Nothing in this policy shall prohibit individual teams from responding to a situation that exceeds their training levels due to the exigency of the circumstances. The preservation of innocent human life is paramount.

439.3.1 POLICY CONSIDERATIONS

A needs assessment should be conducted to determine the type and extent of the Emergency Response Team missions and operations appropriate to this department. The assessment should consider the team's capabilities and limitations and should be reviewed annually by the Emergency Response Team Commander or his/her designee.

439.3.2 ORGANIZATIONAL PROCEDURES

This department shall develop a separate written set of organizational procedures which should address, at minimum, the following:

- (a) Locally identified specific missions the team is capable of performing.
- (b) Team organization and function.
- (c) Personnel selection and retention criteria.
- (d) Training and required competencies.
- (e) Procedures for activation and deployment.
- (f) Command and control issues, including a clearly defined command structure.
- (g) Multi-agency response.
- (h) Out-of-jurisdiction response.
- (i) Specialized functions and supporting resources.

439.3.3 OPERATIONAL PROCEDURES

This department shall develop a separate written set of operational procedures in accordance with the determination of their level of capability, using sound risk reduction practices. The operational procedures should be patterned after the National Tactical Officers Association Suggested SWAT Best Practices. Because such procedures are specific to ERU members and will outline tactical and officer safety issues, they are not included within this policy. The operational procedures should include, at minimum, the following:

- (a) Designated personnel responsible for developing an operational or tactical plan prior to, and/or during ERT operations (time permitting).
 1. ERT members should have an understanding of operational planning.

Culver City Police Department

Culver City PD Policy Manual

Emergency Response Unit

2. ERT training should consider planning for both spontaneous and planned events.
 3. ERT should incorporate medical emergency contingency planning as part of the ERT operational plan.
- (b) Plans for mission briefings conducted prior to an operation, unless circumstances require immediate deployment.
1. When possible, briefings should include the specialized units and supporting resources.
- (c) Protocols for a sustained operation should be developed which may include relief, rotation of personnel and augmentation of resources.
- (d) A generic checklist to be worked through prior to initiating a tactical action as a means of conducting a threat assessment to determine the appropriate response and resources necessary, including the use of ERT.
- (e) The appropriate role for a trained negotiator.
- (f) A standard method of determining whether or not a warrant should be regarded as high-risk.
- (g) A method for deciding how best to serve a high-risk warrant with all reasonably foreseeable alternatives being reviewed in accordance with risk/benefit criteria prior to selecting the method of response.
- (h) Post incident scene management including:
1. Documentation of the incident.
 2. Transition to investigations and/or other units.
 3. Debriefing after every deployment of the ERT team.
 - (a) After-action team debriefing provides evaluation and analysis of critical incidents and affords the opportunity for individual and team assessments, helps to identify training needs, and reinforces sound risk management practices.
 - (b) Such debriefing should not be conducted until involved officers have had the opportunity to individually complete necessary reports or provide formal statements.
 - (c) In order to maintain candor and a meaningful exchange, debriefing will generally not be recorded.
 - (d) When appropriate, debriefing should include specialized units and resources.
- (i) Sound risk management analysis.
- (j) Standardization of equipment deployed.

Culver City Police Department

Culver City PD Policy Manual

Emergency Response Unit

439.4 OPERATION GUIDELINES FOR EMERGENCY RESPONSE UNIT

The following procedures serve as guidelines for the operational deployment of the Emergency Response Unit. Generally, the Emergency Response Team and the Crisis Negotiation Team will be activated together. It is recognized, however, that a tactical team may be used in a situation not requiring the physical presence of the Crisis Negotiation Team such as warrant service operations. This shall be at the discretion of the ERT Commander.

439.4.1 ON-SCENE DETERMINATION

The supervisor in charge on the scene of a particular event will assess whether the Emergency Response Unit is to respond to the scene. Upon final determination by the Watch Commander, he/she will notify the ERT Commander.

439.4.2 APPROPRIATE SITUATIONS FOR USE OF EMERGENCY RESPONSE UNIT

The following are examples of incidents which may result in the activation of the Crisis Response Unit:

- (a) Barricaded suspects who refuse an order to surrender.
- (b) Incidents where hostages are taken.
- (c) Cases of suicide threats.
- (d) Arrests of dangerous persons.
- (e) Any situation that could enhance the ability to preserve life, maintain social order, and ensure the protection of property.

439.4.3 OUTSIDE AGENCY REQUESTS

Requests by field personnel for assistance from outside agency crisis units must be approved by the Watch Commander. Deployment of the Culver City Police Department Emergency Response Unit in response to requests by other agencies must be authorized by a Bureau Commander.

439.4.4 MULTI-JURISDICTIONAL ERT OPERATIONS

The Emergency Response Team, should develop protocols, agreements, or working relationships to support multi-jurisdictional or regional responses.

- (a) If it is anticipated that multi-jurisdictional tactical operations will regularly be conducted; ERT multi-agency and multi-disciplinary joint training exercises are encouraged.
- (b) Members of the Culver City Police Department ERT shall operate under the policies, procedures and command of the Culver City Police Department when working in a multi-agency situation.

439.4.5 MOBILIZATION OF EMERGENCY RESPONSE UNIT

The On-Scene supervisor shall make a request to the Watch Commander for the Emergency Response Unit. The Watch Commander shall then notify the ERT Commander. If unavailable, a team supervisor shall be notified. A current mobilization list shall be maintained in the Watch Commander's office by the ERU Commander. The Watch Commander will then notify the ERT Commander as soon as practical.

Culver City Police Department

Culver City PD Policy Manual

Emergency Response Unit

The Watch Commander should advise the ERT Commander with as much of the following information which is available at the time:

- (a) The number of suspects, known weapons and resources.
- (b) If the suspect is in control of hostages.
- (c) If the suspect is barricaded.
- (d) The type of crime involved.
- (e) If the suspect has threatened or attempted suicide.
- (f) The location of the command post and a safe approach to it.
- (g) The extent of any perimeter and the number of officers involved.
- (h) Any other important facts critical to the immediate situation and whether the suspect has refused an order to surrender.

The ERT Commander or supervisor shall then call selected ERT members and/or CNT members to respond.

439.4.6 FIELD UNIT RESPONSIBILITIES

While waiting for the Emergency Response Unit, field personnel should, if safe, practical and sufficient resources exist:

- (a) Establish an inner and outer perimeter.
- (b) Establish a command post outside of the inner perimeter.
- (c) Establish an arrest/response team. The team actions may include:
 - 1. Securing any subject or suspect who may surrender.
 - 2. Taking action to mitigate a deadly threat or behavior.
- (d) Evacuate any injured persons or citizens in the zone of danger.
- (e) Attempt to establish preliminary communication with the suspect. Once the CRU has arrived, all negotiations should generally be halted to allow the CNT and ERT time to set up.
- (f) Be prepared to brief the ERT Commander on the situation.
- (g) Plan for, and stage, anticipated resources.

439.4.7 ON-SCENE COMMAND RESPONSIBILITIES

Upon arrival of the Emergency Response Unit at the scene, the Incident Commander shall brief the ERT Commander and team supervisors about the situation. Upon review, it will be the Incident Commander's decision, with input from the ERT Commander, whether to deploy the Emergency Response Unit. Once the Incident Commander authorizes deployment, the ERT Commander will be responsible for the tactical portion of the operation. The Incident Commander shall continue supervision of the command post operation, outer perimeter security, and support

Culver City Police Department

Culver City PD Policy Manual

Emergency Response Unit

for the Emergency Response Unit. The Incident Commander and the ERT Commander (or his or her designee) shall maintain communications at all times.

439.4.8 COMMUNICATION WITH EMERGENCY RESPONSE UNIT PERSONNEL

All of those persons who are non-Emergency Response Unit personnel should refrain from any non-emergency contact or interference with any member of the unit during active negotiations. Operations require the utmost in concentration by involved personnel and, as a result, no one should interrupt or communicate with the Crisis Negotiation Team personnel directly. All non-emergency communications shall be channeled through the Crisis Negotiation Team Commander or Sergeant.

439.5 TRAINING NEEDS ASSESSMENT

The ERT Commander shall conduct an annual ERT training needs assessment to ensure that training is conducted within team capabilities, department policy and the training guidelines as established by POST (11 C.C.R. § 1084).

439.5.1 INITIAL TRAINING

ERT operators and ERT supervisors/team leaders should not be deployed until successful completion of the POST-certified Basic SWAT Course or its equivalent.

- (a) To avoid unnecessary or redundant training, previous training completed by members may be considered equivalent when the hours and content (topics) meet or exceed department requirements or POST standardized training recommendations.

439.5.2 UPDATED TRAINING

Appropriate team training for specialized ERT functions and other supporting resources should be completed prior to full deployment of the team.

ERT operators and ERT supervisors/team leaders should complete update or refresher training as certified by POST, or its equivalent, every 24 months.

439.5.3 SUPERVISION AND MANAGEMENT TRAINING

Command and executive personnel are encouraged to attend training for managing the ERT function at the organizational level to ensure personnel who provide active oversight at the scene of ERT operations understand the purpose and capabilities of the teams.

Command personnel who may assume incident command responsibilities should attend ERT or Critical Incident Commander course or its equivalent. ERT command personnel should attend a POST-certified ERT commander or tactical commander course, or its equivalent.

439.5.4 ERT ONGOING TRAINING

Training shall be coordinated by the ERT Commander. The ERT Commander may conduct monthly training exercises that include a review and critique of personnel and their performance in the exercise in addition to specialized training. Training shall consist of the following:

Culver City Police Department

Culver City PD Policy Manual

Emergency Response Unit

- (a) Each ERT member (Officers and Sergeants) shall perform a physical fitness test once each year. A minimum qualifying score must be attained by each team member.
- (b) Any ERT team member failing to attain the minimum physical fitness qualification score will be notified of the requirement to retest and attain a qualifying score. Within 30 days of the previous physical fitness test date, the member required to qualify shall report to a team supervisor and complete the entire physical fitness test. Failure to qualify after a second attempt may result in dismissal from the team.
- (c) Those members who are on vacation, ill, or are on light duty status with a doctor's note of approval on the test date, shall be responsible for reporting to a team supervisor and taking the test within 30 days of their return to regular duty. Any member, who fails to arrange for and perform the physical fitness test within the 30-day period, shall be considered as having failed to attain a qualifying score for that test period.
- (d) Quarterly, each ERT member shall perform the mandatory ERT handgun qualification course. The qualification course shall consist of the ERT Basic Drill for the handgun. Failure to qualify will require that officer to seek remedial training from a team range master approved by the ERT Commander. Team members who fail to qualify must retest within 30 days. Failure to qualify within 30 days with or without remedial training may result in dismissal from the team.
- (e) Each ERT member shall complete the quarterly ERT qualification course for any specialty weapon issued to, or used by, the team member during ERT operations. Failure to qualify will require the team member to seek remedial training from the Rangemaster who has been approved by the ERU commander. Team members who fail to qualify on their specialty weapon may not utilize the specialty weapon on ERT operations until qualified. Team members who fail to qualify must retest within 30 days. Failure to qualify with specialty weapons within 30 days may result in the team member being removed from the team or permanently disqualified from use of that particular specialty weapon.

439.5.5 TRAINING SAFETY

Use of a designated safety officer shall be considered for all tactical training.

439.5.6 SCENARIO BASED TRAINING

All ERT members should participate in scenario-based training that simulates the tactical operational environment. Such training is an established method of improving performance during an actual deployment.

439.5.7 TRAINING DOCUMENTATION

Individual and team training shall be documented and records maintained by the Personnel and Training along with the ERT Sergeants and/or ERT Commander. Such documentation shall be maintained in each member's individual training file. A separate agency ERT training file shall be maintained with documentation and records of all team training, which will be the responsibility of the ERT Sergeant.

439.6 UNIFORMS, EQUIPMENT, AND FIREARMS

Culver City Police Department

Culver City PD Policy Manual

Emergency Response Unit

439.6.1 UNIFORMS

ERT teams from this agency should wear uniforms that clearly identify team members as law enforcement officers. It is recognized that certain tactical conditions may require covert movement. Attire may be selected appropriate to the specific mission.

439.6.2 EQUIPMENT

ERT members should be adequately equipped to meet the specific mission(s) identified by the agency.

439.6.3 FIREARMS

Weapons and equipment used by ERT, members shall be agency-issued or approved by the ERT Rangemaster, ERT Sergeants, and ERT Commander following successful qualification with the weapons and equipment, including but not limited to any modifications, additions, or attachments.

439.6.4 OPERATIONAL READINESS INSPECTIONS

The ERT Commander shall appoint a ERT supervisor to perform operational readiness inspections of all unit equipment at least quarterly. The result of the inspection will be forwarded to the ERT Commander in writing. The inspection will include personal equipment issued to members of the unit, operational equipment maintained in the ERT facility and equipment maintained or used in ERT vehicles.

439.7 MANAGEMENT/SUPERVISION OF EMERGENCY RESPONSE UNIT

The Commander of the ERT shall be selected by the Chief of Police upon recommendation of staff.

439.7.1 PRIMARY UNIT MANAGER

Under the direction of the Chief of Police, through the ERT Commander, the Emergency Response Unit shall be managed by the ERT Captain.

439.7.2 TEAM SUPERVISORS

The Crisis Negotiation Team and Emergency Response Team should be supervised by a minimum of one sergeant and/or one Lieutenant.

The team supervisors shall be selected by the Chief of Police upon specific recommendation by staff and the ERT Captain.

The following represent the supervisor responsibilities for the Emergency Response Unit.

- (a) The Crisis Negotiation Team supervisor's primary responsibility is to supervise the operations of the Negotiation Team which will include deployment, training, first line participation, and other duties as directed by the ERT Commander.
- (b) The Emergency Response Team supervisor's primary responsibility is to supervise the operations of the ERT, which will include deployment, training, first line participation, and other duties as directed by the ERT Commander.

Culver City Police Department

Culver City PD Policy Manual

Emergency Response Unit

439.8 CRISIS NEGOTIATION TEAM ADMINISTRATIVE PROCEDURES

The Crisis Negotiation Team has been established to provide skilled verbal communicators who may be utilized to attempt to de-escalate and effect surrender in critical situations where suspects have taken hostages, barricaded themselves, or have suicidal tendencies.

The following procedures serve as directives for the administrative operation of the Crisis Negotiation Team.

439.8.1 SELECTION OF PERSONNEL

Interested sworn personnel, who are off probation, shall submit an IDC request to their appropriate Bureau Commander via the chain of command, when the Crisis Negotiations Team has anticipated openings announced by the office of the Chief of Police. A copy of the IDC will be forwarded to the ERT Captain and the Crisis Negotiation Team Lieutenant. Qualified applicants will then be selected by members of the Command Staff and will be invited to an oral interview. The oral board will consist of the ERT Commander, CNT Lieutenant, and at least one CNT Sergeant. Interested personnel shall be evaluated by the following criteria:

- a. Recognized competence and ability as evidenced by performance.
- b. Demonstrated good judgment and understanding of critical role of negotiator and negotiation process.
- c. Effective communication skills to ensure success as a negotiator.
- d. Special skills, training, or appropriate education as it pertains to the assignment.
- e. Commitment to the unit, realizing that the assignment may necessitate unusual working hours, conditions, and training obligations.

Selections of Crisis Negotiations members will be chosen by Command Staff personnel and/or the Chief of Police.

439.8.2 TRAINING OF NEGOTIATORS

Those officers selected as members of the Negotiation Team should attend the Basic Negotiators Course as approved by the Commission on Peace Officer Standards and Training (POST) prior to primary use in an actual crisis situation. Untrained officers may be used in a support or training capacity. Additional training will be coordinated by the team supervisor.

A minimum of one training day per quarter will be required to provide the opportunity for role playing and situational training necessary to maintain proper skills. Training scenarios will be coordinated by members and/or supervisors within the Emergency Response Unit.

Continual evaluation of a team member's performance and efficiency as it relates to the positive operation of the unit shall be conducted by the team supervisor. Performance and efficiency levels, established by the team supervisor, will be met and maintained by all team members. Any member of the Crisis Negotiation Team who performs or functions at a level less than satisfactory shall be subject to dismissal from the unit.

Culver City Police Department

Culver City PD Policy Manual

Emergency Response Unit

439.9 ERT ADMINISTRATIVE PROCEDURES

The Emergency Response Team was established to provide a skilled and trained team which may be deployed during events requiring specialized tactics in such situations as cases where suspects have taken hostages and/or barricaded themselves as well as prolonged or predictable situations in which persons armed or suspected of being armed pose a danger to themselves or others.

The following procedures serve as directives for the administrative operation of the Emergency Response Team.

439.9.1 SELECTION OF PERSONNEL

Interested sworn personnel who are off probation shall submit an IDC to their appropriate Bureau Commander, via the chain of command when the ERT has anticipated openings announced by the office of the Chief of Police. A copy of the IDC will be forwarded to the ERT Commander and ERT Sergeants. Those qualifying applicants will then be invited to participate in the testing process. The order of the tests will be given at the discretion of the ERT Commander. The testing process will consist of an oral board, physical agility, ERT firearm qualification, and team evaluation.

- (a) Oral board: The oral board will consist of personnel selected by the ERU Captain and/or ERU Commander. Applicants will be evaluated by the following criteria:
 - 1. Recognized competence and ability as evidenced by performance;
 - 2. Demonstrated good judgment and understanding of the critical role of an ERT member;
 - 3. Special skills, training, or appropriate education as it pertains to this assignment; and,
 - 4. Commitment to the unit, realizing that the additional assignment may necessitate unusual working hours, conditions, and training obligations.
- (b) Physical agility: The physical agility test is designed to determine the physical capabilities of the applicant as it relates to performance of ERT-related duties. The test and scoring procedure will be established by the ERT Commander and ERT Sergeant(s). A minimum qualifying score shall be attained by the applicant to be considered for the position.
- (c) Team evaluation: Current team members will evaluate each candidate on his or her field tactical skills, teamwork, ability to work under stress, communication skills, judgment, and any special skills that could benefit the team.
- (d) A list of successful applicants shall be submitted to staff, by the ERT Commander, for final selection.

439.9.2 TEAM EVALUATION

Continual evaluation of a team member's performance and efficiency as it relates to the positive operation of the unit shall be conducted by the ERT Commander. The performance and efficiency level, as established by the team supervisors, will be met and maintained by all Emergency Response Team members. Any member of the ERT who performs or functions at a level less than satisfactory shall be subject to dismissal from the team.

Racial and Identity Profiling Act (RIPA)

440.1 PURPOSE AND SCOPE

On September 1, 2020, the Department began collecting data on all stops conducted by peace officers within the Department for annual reporting to the California Attorney General.

Commencing on or before April 1, 2022, the Department is required to annually report to the California Attorney General data on all stops conducted by peace officers within the Department during the preceding calendar year (Government Code § 12525.5).

440.1.1 DEFINITIONS

The following definitions relate to terms used within this policy:

Peace officer: Any sworn Department Member working outside a custodial setting.

Stop: Any detention of a person and/or search, including a consensual search, of the person's body or property in the person's possession or control.

Search: defined as a search of a person's body or property in the person's possession or under his or her control, and includes a pat down search of a person's outer clothing as well as a consensual search.

440.2 DATA COLLECTION

Peace officers within the Department shall complete all applicable data fields in the Department's AB 953 RIPA Stop form for each stop. All RIPA reports shall be completed and approved by a supervisor by end of their shift or, if exigent circumstances exist, as soon as practicable.

The data fields include, but are not limited to, the following:

1. The time, date, duration and location of the stop.
2. The reason for the stop.
3. The result of the stop, such as, no action, warning, citation, property seized or arrest.
4. If a warning or citation was issued, the warning provided, or violation cited.
5. If an arrest was made, the offense charged.
6. The perceived race or ethnicity, gender, and approximate age of the person stopped, provided that the identification of these characteristics shall be based on the observation and perception of the peace officer making the stop, and the information shall not be requested from the person stopped. When reporting the required data elements, the peace officer shall make his or her determination based on personal observation only. For motor vehicle stops, this section only applies to the driver, unless any actions specified under subsection 7 apply in relation to a passenger, in which case the characteristics specified in this section shall also be reported for him or her.
7. Actions taken by the peace officer during the stop, including, but not limited to, the following:

Culver City Police Department

Culver City PD Policy Manual

Racial and Identity Profiling Act (RIPA)

- (a) Whether the peace officer asked for consent to search the person, and, if so, whether consent was provided.
- (b) Whether the peace officer searched the person or any property, and, if so, the basis for the search and the type of contraband or evidence discovered, if any.
- (c) Whether the peace officer seized any property and, if so, the type of property that was seized and the basis for seizing the property.

Stops involving multiple peace officers shall only require reporting by one peace officer. In most cases, this shall be the peace officer making initial contact.

440.3 EXCEPTIONS TO COMPLETION REQUIREMENTS

Officers are not required to complete a RIPA report in the following circumstances:

1. Detentions that occur during public safety mass evacuations, including bomb threats, gas leaks, flooding, earthquakes, and other similar critical incidents.
2. Detentions that occur during an active shooter incident, such as when an individual is actively engaged in killing or attempting to kill people in a populated area.
3. Detentions or searches that occur during or as a result of routine security screenings required of all persons entering a building, school, or special event, including metal detector screenings and any secondary searches that result from that screening.
4. Detentions that occur during a crowd control situation in which pedestrians are directed to remain at a location or are routed to a different location for public safety purposes.
5. Interactions during which persons are detained at a residence only, so that officers may check for proof of age for purposes of investigating underage drinking.
6. Checkpoints or roadblocks in which an officer detains a person as the result of a blanket regulatory activity that is not based on an individualized suspicion or personal characteristic.
7. Passenger(s) of traffic stops who are not the subject of an investigation or enforcement action (e.g., any person being asked to exit the vehicle simply because it is being impounded).
8. The targeted subject(s) of a warrant, search condition, home detention, or house arrest while in their residence.
9. Consensual encounters that do not result in a search or detention.

440.4 MULTIPLE OFFICERS

When there are multiple officers at the scene and interacting with the detained or searched person(s):

- (a) Only one officer shall submit the RIPA form.
- (b) The officer with the highest level of engagement (contact or interaction) is responsible for completing the RIPA form.

Culver City Police Department

Culver City PD Policy Manual

Racial and Identity Profiling Act (RIPA)

440.5 SUPERVISOR RESPONSIBILITIES

Supervisors shall be responsible for:

- (a) Reviewing RIPA forms in a timely manner to ensure that officers are properly completing RIPA documentation in accordance with AB 953.
- (b) Editing or directing the completing officer to revise the narrative portions of the RIPA form, when appropriate.

440.6 WATCH COMMANDER RESPONSIBILITIES

Watch commanders shall be responsible for ensuring that supervisors review all RIPA forms for completeness and accuracy in a timely manner.

All RIPA reports shall be completed by end of watch or, if exigent circumstances exist, as soon as practicable.

440.7 REPORTING TO THE CALIFORNIA ATTORNEY GENERAL

The Records Section Supervisor is the custodian of all data collected. The Records Section Supervisor or his/her authorized designee shall ensure data is collected and reported in accordance with Government Code section 12525.5 and that all data collected is used strictly within the scope of compliance with this policy. The data provided to the California Attorney General shall not include the name, address, social security number or other unique personal identifying information of persons stopped, searched or subjected to a property seizure, and shall not include any unique identifying information of the peace officer collecting the data.

All RIPA data collected is public record and open to public inspection. No identifying information about the peace officers collecting the data shall be publicly disclosed.

Department Members, other than the Records Section Supervisor, or his/her designee, may not access the Department's server to view RIPA data without authorization from the Chief of Police or designee. The RIPA data collected shall not be used for disciplinary purposes or for use in performance evaluations.

Chapter 5 - Traffic Operations

Traffic Function and Responsibility

500.1 PURPOSE AND SCOPE

The ultimate goal of traffic law enforcement is to reduce traffic collisions. This may be achieved through the application of such techniques as geographic/temporal assignment of personnel and equipment and the establishment of preventive patrols to deal with specific categories of unlawful driving behavior. Traffic enforcement techniques are based on accident data, enforcement activity records, traffic volume, and traffic conditions. This department provides enforcement efforts toward violations, not only in proportion to the frequency of their occurrence in accident situations, but also in terms of traffic-related needs.

500.2 TRAFFIC OFFICER DEPLOYMENT

Several factors are considered in the development of deployment schedules for officers of the Culver City Police Department. Information provided by the California Statewide Integrated Traffic Reporting System (SWITRS) is a valuable resource for traffic accident occurrences and therefore officer deployment. Some of the factors for analysis include:

- Location
- Time
- Day
- Violation factors

All officers assigned to patrol or traffic enforcement functions will emphasize enforcement of accident causing violations during high accident hours and at locations of occurrence. All officers will take directed enforcement action on request, and random enforcement action when appropriate against violators as a matter of routine. All officers shall maintain high visibility while working general enforcement, especially at high accident locations.

Other factors to be considered for deployment are requests from the public, construction zones or special events.

500.3 ENFORCEMENT

Enforcement actions are commensurate with applicable laws and take into account the degree and severity of the violation committed. This department does not establish ticket quotas and the number of arrests or citations issued by any officer shall not be used as the sole criterion for evaluating officer overall performance (Vehicle Code § 41603). The visibility and quality of an officer's work effort will be commensurate with the philosophy of this policy. Several methods are effective in the reduction of collisions:

500.3.1 WARNINGS

Warnings or other non-punitive enforcement actions should be considered in each situation and substituted for arrests or citations when circumstances warrant, especially in the case of inadvertent violations.

Culver City Police Department

Culver City PD Policy Manual

Traffic Function and Responsibility

500.3.2 CITATIONS

Citations may be issued when an officer believes it is appropriate. It is essential that officers fully explain the rights and requirements imposed on motorists upon issuance of a citation for a traffic violation. Officers should provide the following information at a minimum:

- (a) Explanation of the violation or charge
- (b) Court appearance procedure including the optional or mandatory appearance by the motorist
- (c) Notice of whether the motorist can enter a plea and pay the fine by mail or at the court

500.3.3 PHYSICAL ARREST

Physical arrest can be made on a number of criminal traffic offenses outlined in the Vehicle Code or Penal Code. These physical arrest cases usually deal with, but are not limited to:

- (a) Vehicular manslaughter
- (b) Felony and misdemeanor driving under the influence of alcohol/drugs
- (c) Felony or misdemeanor hit-and-run
- (d) Refusal to sign notice to appear
- (e) Any other misdemeanor at the discretion of the officer, such as reckless driving with extenuating circumstances

500.4 SUSPENDED OR REVOKED DRIVERS LICENSES

If an officer contacts a traffic violator for driving on a suspended or revoked license, the officer may issue a traffic citation pursuant to Vehicle Code § 14601.

If a computer check of a traffic violator's license status reveals a suspended or revoked driver license and the traffic violator still has his or her license in possession, the license shall be seized by the officer. The officer shall verbally advise the traffic violator of the suspension or revocation and issue the citation. The officer will be responsible for filling out the Verbal Notice form (DMV form DL-310) and submitting that form and license to the Traffic Investigator.

500.5 HIGH-VISIBILITY VESTS

The Department has provided American National Standards Institute (ANSI) Class II high-visibility vests to increase the visibility of department members who may be exposed to hazards presented by passing traffic, maneuvering or operating vehicles, machinery and equipment (23 CFR 655.601; 8 CCR 1598).

Although intended primarily for use while performing traffic related assignments, high-visibility vests should be worn at any time increased visibility would improve the safety or efficiency of the member.

Culver City Police Department

Culver City PD Policy Manual

Traffic Function and Responsibility

500.5.1 REQUIRED USE

Except when working in a potentially adversarial or confrontational role, such as during vehicle stops, high-visibility vests should be worn at any time it is anticipated that an employee will be exposed to the hazards of approaching traffic or construction and recovery equipment. Examples of when high-visibility vests should be worn include traffic control duties, accident investigations, lane closures and while at disaster scenes, or anytime high visibility is desirable. When emergency conditions preclude the immediate donning of the vest, officers should retrieve and wear the vest as soon as conditions reasonably permit. Use of the vests shall also be mandatory when directed by a supervisor.

Traffic Collision Reporting

501.1 PURPOSE AND SCOPE

The Culver City Police Department prepares traffic collision reports in compliance with the California Highway Patrol Collision Investigation Manual (CIM) and as a public service makes traffic collision reports available to the community with some exceptions.

501.2 RESPONSIBILITY

The Special Operations Lieutenant will be responsible for distribution of the Collision Investigation Manual. The Special Operations Bureau Commander will receive all changes in the state manual and ensure conformity with this policy.

501.3 TRAFFIC COLLISION REPORTING

All traffic collision reports taken by members of this department shall be forwarded to the Traffic Section. The Special Operations Bureau Lieutenant will be responsible for monthly and quarterly reports on traffic collision statistics to be forwarded to the Special Operations Bureau Commander, or other persons as required.

501.4 DEFINITIONS

Traffic Accident or Collision - An unintended event that produces damage or injury involving a vehicle in-transport.

Traffic Collision Report - Contains the following headings: Notification, Statements, Summary, Area of Impact, Cause. These headings can be used with a CHP555-03 Property Damage Only (PDO) form.

Traffic Collision Investigation (CHP555) - Contains the following headings: FACTS, Notification, Scene, Parties, Physical Evidence, Hit and Run, Hazardous Material, Other factual Information, STATEMENTS, OPINION AND CONCLUSIONS, Summary, Area of Impact, Intoxication, Cause, RECOMMENDATIONS.

Officer's Report - An internal report completed using a Traffic Collision Report format.

501.5 REPORTING SITUATIONS

A motor vehicle collision is any incident that results in unintended injury or property damage attributed directly or indirectly to a motor vehicle or its load, either on a public roadway or on private property.

501.5.1 TRAFFIC COLLISIONS INVOLVING CITY VEHICLES

Any city owned vehicle involved in a collision within Culver City involving an unoccupied vehicle or a fixed object may, at the discretion of the Special Operations Bureau Commander or Watch Commander or designee, be documented on an Officer's Report using a Traffic Collision Report format or a CHP555-03 Property Damage Only (PDO) form. All other traffic collisions shall be documented as a Traffic Collision Investigation (CHP555).

Culver City Police Department

Culver City PD Policy Manual

Traffic Collision Reporting

If an employee is involved in a motor vehicle collision in Culver City resulting in injury, the following procedures will apply:

- (a) A collision involving a City vehicle and another occupied vehicle, on or off the roadway, should be documented on a report.
- (b) A collision involving a City vehicle and an unoccupied vehicle on the roadway should be documented on a report.

An uninvolved officer should complete the required report. The on-scene Police Department supervisor will make the determination as to who will complete the report. The report shall contain all of the information typically found in a Traffic Collision Report. This includes involved parties, witnesses, statements, names of property owners, etc. The report may require a diagram if the damage to either city property or private property is significant. Whenever there is damage to a City vehicle, a Vehicle Damage Report shall be completed and forwarded to the appropriate Bureau Commander. Photographs of the collision scene and vehicle damage shall be taken at the discretion of the traffic investigator or any supervisor.

501.5.2 TRAFFIC COLLISIONS INVOLVING POLICE DEPARTMENT EMPLOYEES

When an employee of this department, off-duty, is involved in a traffic collision within the jurisdiction of the Culver City Police Department resulting in a serious injury or fatality, or a crime is involved, the Special Operations Bureau Commander or the Watch Commander, may notify the California Highway Patrol for assistance. The term serious injury is defined as any injury that may result in a fatality.

When an employee of this department, on-duty, is involved in a traffic collision within the jurisdiction of the Culver City Police Department resulting in any injury, or a crime is involved, the Special Operations Bureau Commander, the Watch Commander, or the Special Operations Lieutenant shall notify the California Highway Patrol (CHP) who may handle the traffic collision investigation. The CHP should also handle any criminal investigation related to the traffic collision (e.g. driving while under the influence)

When an employee of this department, off-duty, is involved in a traffic collision outside the jurisdiction of the Culver City Police Department, the agency having jurisdiction over the area in which the accident occurred will handle the incident.

When an employee of this department, on-duty, is involved in a traffic collision outside the jurisdiction of the Culver City Police Department resulting in any injury, or a crime is involved, the agency having jurisdiction over the area in which the accident occurred will handle the incident. If the agency having jurisdiction over the area in which the accident occurred refuses to handle the incident, the Special Operations Bureau Commander, the Watch Commander, or the Special Operations Lieutenant may notify the California Highway Patrol (CHP) to handle the traffic collision investigation. The CHP or agency having jurisdiction over the area in which the accident occurred may also handle any criminal investigation related to the traffic collision (e.g. driving while under the influence).

Culver City Police Department

Culver City PD Policy Manual

Traffic Collision Reporting

On-duty personnel involved in a traffic collision shall notify a Culver City Police Department communications operator and request a supervisor be dispatched to the scene. If a Culver City police supervisor cannot respond to a traffic collision involving a police department employee, then said employee shall give a verbal statement to the investigating jurisdictional agency. When an on-duty employee is involved in a traffic collision outside of the Culver City boundaries, the law enforcement agency that has jurisdiction over the area where the accident occurred shall be notified and requested to respond to the scene. If the jurisdictional agency refuses to take a report on a minor damage, non-injury accident the Culver City Police Department shall take an accident report with a copy submitted to the involved employees Bureau Commander.

Normally, the California Highway Patrol will not investigate a traffic collision involving non-emergency vehicles (ie; parking enforcement, busses, public works truck), nor will they investigate emergency vehicles in which there is property damage only. However, the handling supervisor must evaluate the totality of the circumstances and determine if it is in the city's best interest to request the California Highway Patrol to respond and investigate the incident. It will be the determination of the California Highway Patrol whether or not this request will be honored.

501.5.1 TRAFFIC COLLISIONS WITH OTHER CITY EMPLOYEES OR OFFICIALS

The Special Operations Commander or on-duty Watch Commander may request assistance from the California Highway Patrol for the investigation of any traffic collision involving any City official or employee where a serious injury or fatality has occurred.

501.5.4 TRAFFIC COLLISIONS ON PRIVATE PROPERTY INVOLVING CITY OWNED VEHICLES

Non-injury and property damage only collisions occurring on private property may be taken at the discretion of the handling officer(s), and in compliance with the Collision Investigation Manual. An Officer's Report may be used to document the collision.

A Collision occurring on private property resulting in injury or as the result of a crime (e.g., hit and run or driving under the influence) shall be documented in a Traffic Collision Report.

501.5.5 TRAFFIC COLLISIONS ON ROADWAYS OR HIGHWAYS INVOLVING CITY OWNED VEHICLES

Traffic collision reports shall be taken when they occur on a roadway or highway within the jurisdiction of this department when there is a death or injury to any persons involved in the collision.

501.5.6 ADDITIONAL PROCEDURES

Department personnel involved in traffic collisions while driving City vehicles:

- (a) With due consideration for safety and traffic, the vehicle(s) should not be moved until after a supervisor arrives on scene.
- (b) If the vehicle is moved prior to the arrival of a supervisor then, when practical, the point of impact and point of rest shall be marked.

Culver City Police Department

Culver City PD Policy Manual

Traffic Collision Reporting

- (c) Photographs should generally be taken. The on scene supervisor shall coordinate the taking of photographs. Photographs are required, and shall be taken, when the accident involves injury, fatality, or extensive damage.
- (d) Involved personnel must give a verbal statement of the accident's details to the investigating officer for inclusion in the Traffic Collision Report.
- (e) The supervisor shall make a log entry summarizing the facts of the accident, noting the appropriate report numbers.
- (f) The on scene supervisor should read a completed copy of the report to ensure it is complete and consistent with the facts and observations made at the scene of the collision.
- (g) The supervisor shall complete the appropriate BlueTeam entry.

501.6 TRAFFIC COLLISIONS ON PRIVATE PROPERTY

Non-injury and property damage only collisions occurring on private property may have a report taken at the discretion of the handling officer(s), and in compliance with the Collision Investigation Manual. An Officer's Report using a Traffic Collision Report format or a CHP555-03 Property Damage Only form may be used to document the collision.

A collision occurring on private property resulting in injury or as the result of a crime (e.g., hit and run or driving under the influence) shall be documented in a Traffic Collision Report.

501.7 NOTIFICATION OF TRAFFIC SECTION SUPERVISION

In the event of a serious injury or death related traffic collision, the Watch Commander shall notify the Special Operations Bureau Commander to relate the circumstances of the traffic collision and seek assistance from the Traffic Section. In the absence of a Special Operations Bureau Commander, the Watch Commander or any supervisor may assign an accident investigator or motor officer to investigate the traffic collision. During hours in which traffic personnel are not on-duty, the Watch Commander shall notify the on-call traffic investigator, who will respond to the station and handle the investigation.

In the event of a serious injury or death related traffic collision involving an on-duty employee, the Watch Commander shall make the following notifications as soon as practical:

- (a) Chief of Police
- (b) Assistant Chief of Police
- (c) Special Operations and Patrol Bureau Commanders
- (d) Professional Standards Unit Lieutenant
- (e) Officer(s) representative(s) (if requested and if applicable)

All outside inquiries about the incident shall be directed to the Watch Commander.

501.7.1 RELEASE OF TRAFFIC COLLISION REPORTS INVOLVING CITY VEHICLES

Traffic collision reports or investigations involving city vehicles will not be released or disseminated without the approval of the Chief of Police or a Bureau Commander.

Vehicle Towing and Release

502.1 PURPOSE AND SCOPE

This policy provides the procedures for towing a vehicle by or at the direction of the Culver City Police Department. Nothing in this policy shall require the Department to tow a vehicle.

502.2 STORAGE AND IMPOUNDS

The responsibilities of those employees towing, storing or impounding a vehicle are listed below.

502.2.1 VEHICLE STORAGE REPORT

Department members requesting towing, storage, or impound of a vehicle shall complete CHP Form 180 and accurately record the mileage and a description of property within the vehicle (Vehicle Code § 22850). A copy of the storage report should be given to the tow truck operator, and the original shall be submitted to the Records Section as soon as practicable after the vehicle is stored.

502.2.2 REMOVAL FROM TRAFFIC COLLISION SCENES

When a vehicle has been involved in a traffic collision and must be removed from the scene, the officer should ask the driver select a towing company, if possible, and relay the request for the specified towing company to the dispatcher. When there is no preferred company requested, or the requested towing company has an unreasonable estimated time of arrival, the officer shall request the dispatcher to call an official towing garage for the City of Culver City.

If the owner is incapacitated, or for any reason it is necessary for the Department to assume responsibility for a vehicle involved in a collision, the officer shall request the dispatcher to call an official towing garage for the City of Culver City. The officer will then store the vehicle using a CHP Form 180.

502.2.3 STORAGE AT ARREST SCENES

Whenever a person in charge or in control of a vehicle is arrested, it is the policy of this department to provide reasonable safekeeping by storing the arrestee's vehicle subject to the exceptions described below. The vehicle, however, shall be stored whenever it is needed for the furtherance of the investigation or prosecution of the case, or when the community caretaker doctrine would reasonably suggest that the vehicle should be stored (e.g., traffic hazard, high-crime area). However, searches and impounds of vehicles in the interest of community-caretaking shall only be conducted with the expressed approval of a Department supervisor.

The following are examples of situations where consideration should be given to leaving a vehicle at the scene in lieu of storing, provided the vehicle can be lawfully parked and left in a reasonably secure and safe condition:

- Traffic-related warrant arrest.
- Situations where the vehicle was not used to further the offense for which the driver was arrested.

Culver City Police Department

Culver City PD Policy Manual

Vehicle Towing and Release

- Whenever the licensed owner of the vehicle is present, willing, and able to take control of any vehicle not involved in criminal activity.
- Whenever the vehicle otherwise does not need to be stored and the owner requests that it be left at the scene. In such cases, the owner shall be informed that the Department will not be responsible for theft or damages.

502.2.4 IMPOUNDMENT AT SOBRIETY CHECKPOINTS

Whenever a driver is stopped at a sobriety checkpoint and the only violation is that the operator is driving without a valid driver's license, the officer shall make a reasonable attempt to identify the registered owner of the vehicle (Vehicle Code § 2814.2). The officer shall release the vehicle to the registered owner if the person is a licensed driver, or to another licensed driver authorized by the registered owner, provided the vehicle is claimed prior to the conclusion of the checkpoint operation.

If the vehicle is released at the checkpoint, the officer shall list on his/her copy of the notice to appear the name and driver's license number of the person to whom the vehicle is released.

When a vehicle cannot be released at the checkpoint, it shall be towed (Vehicle Code § 22651(p)). When a vehicle is removed at the checkpoint, it shall be released during the normal business hours of the storage facility to the registered owner or his/her agent upon presentation of a valid driver's license and current vehicle registration.

502.2.5 DRIVING A NON-CITY VEHICLE

Vehicles which have been towed by or at the direction of the Department should not be driven by police personnel unless it is necessary to move a vehicle a short distance to eliminate a hazard, prevent the obstruction of a fire hydrant or to comply with posted signs.

502.2.6 DISPATCHER'S RESPONSIBILITIES

Upon receiving a request for towing, the dispatcher shall promptly telephone the specified authorized towing service. The officer shall be advised when the request has been made and the towing service has been dispatched.

502.2.7 RECORDS SECTION RESPONSIBILITY

Records personnel shall promptly enter pertinent data from the completed storage form (CHP Form 180) into the Stolen Vehicle System and return the form to the Watch Commander for approval (Vehicle Code § 22651.5(b); Vehicle Code § 22851.3(b); Vehicle Code § 22854.5).

Approved storage forms shall be promptly placed into the auto-file so that they are immediately available for release or review should inquiries be made.

Within 48 hours, excluding weekends and holidays, of the storage of any such vehicle it shall be the responsibility of the Records Section to determine the names and addresses of any individuals having an interest in the vehicle through DMV or CLETS computers. Notice shall be sent to all such individuals by mail as applicable and as provided in Vehicle Code § 22851.3(d), Vehicle Code §

Culver City Police Department

Culver City PD Policy Manual

Vehicle Towing and Release

22852(a), and Vehicle Code § 14602.6(a)(2). The notice shall include the following (Vehicle Code § 22852(b)):

- (a) The name, address, and telephone number of this Department
- (b) The location of the place of storage and description of the vehicle, which shall include, if available, the name or make, the manufacturer, the license plate number, and the mileage
- (c) The authority and purpose for the removal of the vehicle
- (d) A statement that, in order to receive their post-storage hearing, the owners, or their agents, shall request the hearing in person, in writing, or by telephone within 10 days of the date appearing on the notice

502.3 TOWING SERVICES

The City of Culver City periodically selects a firm to act as the official tow service and awards a contract to that firm. This firm will be used in the following situations:

- (a) When it is necessary to safeguard a vehicle due to the inability of the owner or operator to take the required action.
- (b) When a vehicle is being held as evidence in connection with an investigation.
- (c) When it is otherwise necessary to store a motor vehicle. This would include situations such as the recovery of stolen or abandoned vehicles, and the removal of vehicles obstructing traffic in violation of state or local regulations.

502.4 VEHICLE INVENTORY

All property in a stored or impounded vehicle shall be inventoried and listed on the vehicle storage form. This includes the trunk and any compartments or containers, even if closed and/or locked. Members conducting inventory searches should be as thorough and accurate as practical in preparing an itemized inventory. These inventory procedures are for the purpose of protecting an owner's property while in police custody, to provide for the safety of officers, and to protect the Department against fraudulent claims of lost, stolen, or damaged property.

Inventory searches of vehicles stored or impounded pursuant to the Community Caretaking Doctrine shall only be conducted with the expressed approval of a Department supervisor.

502.5 SECURITY OF VEHICLES AND PROPERTY

Unless it would cause an unreasonable delay in the completion of a vehicle impound/storage or create an issue of officer safety, officers should make reasonable accommodations to permit a driver/owner to retrieve small items of value or personal need (e.g., cash, jewelry, cell phone, prescriptions) that are not considered evidence or contraband.

If a search of a vehicle leaves the vehicle or any property contained therein vulnerable to unauthorized entry, theft, or damage, personnel conducting the search shall take such steps as are reasonably necessary to secure and/or preserve the vehicle or property from such hazards.

Culver City Police Department

Culver City PD Policy Manual

Vehicle Towing and Release

502.6 RELEASE OF VEHICLE

The Department will maintain a listed, 24-hour telephone number to provide information regarding impoundment of vehicles and the right of the registered owner to request a storage hearing. Releases for towed vehicles will be made available during regular, non-emergency business hours (Vehicle Code § 14602.6).

- (a) Vehicles removed pursuant to Vehicle Code § 22850 shall be released after proof of current registration is provided by the owner or the person in control of the vehicle and after all applicable fees are paid (Vehicle Code § 22850.3; Vehicle Code § 22850.5).
- (b) Vehicles removed that require payment of parking fines or proof of valid driver's license shall only be released upon presentation of proof of compliance, proof of payment, completion of affidavit, and payment of applicable fees related to the removal (Vehicle Code § 22651 et seq., Vehicle Code § 22652 et seq., Vehicle Code § 22850.3; Vehicle Code § 22850.5).
- (c) A vehicle removed pursuant to Vehicle Code § 14602.6(a) shall be released to the registered owner or his/her agent with proof of current registration, proof of a valid driver's license, and applicable fees paid prior to the end of the 30-day impoundment period under any of the following circumstances:
 - 1. The vehicle was stolen.
 - 2. If the driver reinstates his/her driver's license or acquires a license and provides proof of proper insurance.
 - 3. Any other circumstance as set forth in Vehicle Code § 14602.6.
 - 4. When there is no remaining community caretaking need to continue impound of the vehicle or the continued impound would not otherwise comply with the Fourth Amendment.
- (d) An autonomous vehicle removed under authority of Vehicle Code § 22651(o)(1)(D) shall be released to the registered owner or person in control of the autonomous vehicle if the requirements of Vehicle Code § 22651(o)(3)(B) are met.

Personnel whose duties include releasing towed vehicles should consult the Vehicle Code under which the vehicle was towed or impounded for any specific requirements prior to release.

Employees who suspect that a vehicle was impounded in error should promptly advise a supervisor. When appropriate, Supervisors should approve the release of the vehicle without requiring the registered owner or his/her agent to request a hearing, as described in the Vehicle Impound Hearings Policy and may waive the Department's release fee.

502.7 TOWING FOR EXPIRED REGISTRATION

Prior to a member removing a vehicle that is found to have expired registration for more than six months, the member shall verify that no current registration exists with the Department of Motor Vehicles (DMV). If current registration exists with the DMV, the vehicle shall not be removed (Vehicle Code § 22651(o)(1)(A)).

Vehicle Impound Hearings

503.1 PURPOSE AND SCOPE

This policy establishes a procedure for the requirement to provide vehicle storage or impound hearings pursuant to Vehicle Code § 22852.

503.2 STORED OR IMPOUND HEARING

When a vehicle is stored or impounded by any member of the Culver City Police Department, a hearing will be conducted upon the request of the registered or legal owner of the vehicle or his/her agent (Vehicle Code § 22650(a); Vehicle Code § 22852(a)).

The hearing shall be conducted within 48 hours of the request, excluding weekends and holidays. The hearing officer must be a person other than the person who directed the storage or impound of the vehicle (Vehicle Code § 22852(c)).

503.2.1 HEARING PROCEDURES

The vehicle storage hearing is an informal process to evaluate the validity of an order to store or impound a vehicle. The employee who caused the storage or removal of the vehicle does not need to be present for this hearing.

All requests for a hearing on a stored or impounded vehicle shall be submitted in person, in writing or by telephone within 10 days of the date appearing on the required notice (Vehicle Code § 22852(d)). The Traffic Bureau Commander or his/her designee will serve as the hearing officer. The person requesting the hearing may record the hearing at his/her own expense.

The failure of either the registered or legal owner or interested person or his/her agent to request a hearing in a timely manner or to attend a scheduled hearing shall be considered a waiver of and satisfaction of the post-storage hearing requirement (Vehicle Code §§ 22851.3(e)(2) and 22852(d)).

Any relevant evidence may be submitted and reviewed by the hearing officer to determine if reasonable grounds have been established for the storage or impound of the vehicle. The initial burden of proof established by a preponderance of the evidence that the storage/impound was based on probable cause rests with the Department.

After consideration of all information, the hearing officer shall determine the validity of the storage or impound of the vehicle in question and then render a decision. The hearing officer shall also consider any mitigating circumstances attendant to the storage that reasonably would warrant the release of the vehicle or a modification or reduction of the period the vehicle is impounded (Vehicle Code §§ 14602.6(b) and 14602.8(b)).

Aside from those mitigating circumstances enumerated in the Vehicle Code, the registered owner's lack of actual knowledge that the driver to whom the vehicle was loaned was not validly licensed may constitute a mitigating circumstance under Vehicle Code §§ 14602.6(b) or 14608(b), warranting release of the vehicle. This mitigating circumstance exception is not limited to situations

Culver City Police Department

Culver City PD Policy Manual

Vehicle Impound Hearings

where the owner made a reasonable inquiry as to the licensed status of the driver before lending the vehicle.

The legislative intent and this department's policy is to prevent unlicensed driving pursuant to Vehicle Code §14602.6. If this purpose is not furthered by the continued impoundment of a vehicle, release is most often appropriate.

- (a) If a decision is made that reasonable grounds for storage or impound have been established, the hearing officer shall advise the inquiring party of the decision and that the inquiring party may pursue further civil remedies if desired.
 - 1. If mitigating circumstances are found to be relevant, the hearing officer shall make reasonable adjustments to the impound period, storage or assessment of fees as warranted.
- (b) If a decision is made that reasonable grounds for storage or impound have not been established or sufficient mitigating circumstances exist, the vehicle in storage shall be released immediately. Towing and storage fees will be paid at the Department's expense (Vehicle Code § 22852(e)).
- (c) If a decision is made that reasonable grounds for storage have not been established or sufficient mitigating circumstances exist, and the vehicle has been released with fees having been paid, the receipt for such fees will be forwarded with a letter to the appropriate Bureau Commander. The hearing officer will recommend to the appropriate Bureau Commander that the fees paid by the registered or legal owner of the vehicle in question or their agent be reimbursed by the Department.

Impaired Driving

504.1 PURPOSE AND SCOPE

This policy provides guidance to those department members who play a role in the detection and investigation of driving under the influence (DUI).

504.2 POLICY

The Culver City Police Department is committed to the safety of the roadways and the community and will pursue fair but aggressive enforcement of California's impaired driving laws.

504.3 INVESTIGATIONS

Officers should not enforce DUI laws to the exclusion of their other duties unless specifically assigned to DUI enforcement. All officers are expected to enforce these laws with due diligence.

The Traffic Lieutenant will develop and maintain, in consultation with the prosecuting attorney, report forms with appropriate checklists to assist investigating officers in documenting relevant information and maximizing efficiency. Any DUI investigation will be documented using these forms. Information documented elsewhere on the form does not need to be duplicated in the report narrative. Information that should be documented includes, at a minimum:

- (a) The field sobriety tests (FSTs) administered and the results.
- (b) The officer's observations that indicate impairment on the part of the individual, and the officer's health-related inquiries that may help to identify any serious health concerns (e.g., diabetic shock).
- (c) Sources of additional information (e.g., reporting party, witnesses) and their observations.
- (d) Information about any audio and/or video recording of the individual's driving or subsequent actions.
- (e) The location and time frame of the individual's vehicle operation and how this was determined.
- (f) Any prior related convictions in California or another jurisdiction.

504.4 FIELD TESTS

Officers conducting Field Sobriety Tests as part of a DUI investigations shall, when possible, use the Standardized Field Sobriety Test (SFST's). The three Standardized Field Sobriety Tests are Horizontal Gaze Nystagmus (HGN), the Walk-and-Turn (WAT), and the One-Leg Stand. Alternate FST's include the Romberg Stand, the Finger-to-Nose, and the Finger Count. Officers should use the SFSTs exclusively, unless the subject of the investigation is incapable of performing these tests (i.e. injuries, physical limitations, etc.) If a subject is incapable of performing the SFSTs, the officer may use alternate department approved field tests.

Culver City Police Department

Culver City PD Policy Manual

Impaired Driving

504.5 CHEMICAL TESTS

A person implies consent to a chemical test or tests, and to providing the associated chemical sample, under any of the following (Vehicle Code § 23612):

- (a) The person is arrested for driving a vehicle while under the influence, pursuant to Vehicle Code § 23152.
- (b) The person is under 21 years of age and is arrested by an officer having reasonable cause to believe that the person's blood alcohol content is 0.05 or more (Vehicle Code § 23140).
- (c) The person is under 21 years of age and detained by an officer having reasonable cause to believe that the person was driving a vehicle while having a blood alcohol content of 0.01 or more (Vehicle Code § 23136).
- (d) The person was operating a vehicle while under the influence and proximately caused bodily injury to another person (Vehicle Code § 23153).

If a person withdraws this implied consent, or is unable to withdraw consent (e.g., the person is unconscious), the officer should consider implied consent revoked and proceed as though the person has refused to provide a chemical sample.

504.5.1 CHOICE OF TESTS

Officers shall respect a viable choice of chemical test made by an arrestee, as provided for by law (e.g., breath will not be acceptable for suspected narcotics influence).

A person arrested for DUI has the choice of whether the test is of the person's blood or breath, and the officer shall advise the person that the person has that choice. If the person arrested either is incapable, or states that the person is incapable, of completing the chosen test, the person shall submit to the remaining test.

If the person chooses to submit to a breath test and there is reasonable cause to believe that the person is under the influence of a drug or the combined influence of alcohol and any drug, the officer may also request that the person submit to a blood test. If the person is incapable of completing a blood test, the person shall submit to and complete a urine test (Vehicle Code § 23612(a)(2)(C)).

504.5.2 BREATH SAMPLES

The Traffic Section Lieutenant should ensure that all devices used for the collection and analysis of breath samples are properly serviced and tested, and that a record of such service and testing is properly maintained.

Officers obtaining a breath sample should monitor the device for any sign of malfunction. Any anomalies or equipment failures should be noted in the appropriate report and promptly reported to the Traffic Section Lieutenant.

When the arrested person chooses a breath test, the handling officer shall advise the person that the breath-testing equipment does not retain a sample, and the person may, if desired, provide a

Culver City Police Department

Culver City PD Policy Manual

Impaired Driving

blood or urine specimen, which will be retained to facilitate subsequent verification testing (Vehicle Code § 23614).

The officer should also require the person to submit to a blood test if the officer has a clear indication that a blood test will reveal evidence of any drug or the combined influence of an alcoholic beverage and any drug. Evidence of the officer's belief shall be included in the officer's report (Vehicle Code § 23612(a)(2)(C)).

504.5.3 BLOOD SAMPLES

Only persons authorized by law to draw blood shall collect blood samples (Vehicle Code § 23158). The blood draw should be witnessed by the assigned officer. No officer, even if properly certified, should perform this task.

Officers should inform an arrestee that if the arrestee chooses to provide a blood sample, a separate sample can be collected for alternate testing. Unless medical personnel object, two samples should be collected and retained as evidence, so long as only one puncture is required.

The blood sample shall be packaged, marked, handled, stored, and transported as required by the testing facility.

If an arrestee cannot submit to a blood draw because the arrestee has a bleeding disorder or has taken medication that inhibits coagulation, the arrestee shall not be required to take a blood test. Such inability to take a blood test should not be considered a refusal. However, that arrestee may be required to complete another available and viable test.

504.5.4 URINE SAMPLES

If a urine test will be performed, the arrestee should be promptly transported to the appropriate testing site. The officer shall follow any directions accompanying the urine evidence collection kit.

Urine samples shall be collected and witnessed by an officer or jail staff member of the same sex as the individual giving the sample. The arrestee should be allowed sufficient privacy to maintain the arrestee's dignity, to the extent possible, while still ensuring the accuracy of the sample (Vehicle Code § 23158(i)).

The sample shall be packaged, marked, handled, stored, and transported as required by the testing facility.

504.5.5 STATUTORY NOTIFICATIONS

Officers requesting that a person submit to chemical testing shall provide the person with the mandatory warning pursuant to Vehicle Code § 23612(a)(1)(D) and Vehicle Code § 23612(a)(4).

504.5.6 PRELIMINARY ALCOHOL SCREENING

Officers may use a preliminary alcohol screening (PAS) test to assist in establishing reasonable cause to believe a person is DUI. The officer shall advise the person that the PAS test is being requested to assist in determining whether the person is under the influence of alcohol or drugs, or a combination of the two. Unless the person is under the age of 21, the person shall be advised

Culver City Police Department

Culver City PD Policy Manual

Impaired Driving

that the PAS test is voluntary. The officer shall also advise the person that submitting to a PAS test does not satisfy the person's obligation to submit to a chemical test as otherwise required by law (Vehicle Code § 23612).

504.5.7 PRELIMINARY ALCOHOL SCREENING FOR A PERSON UNDER AGE 21

If an officer lawfully detains a person under 21 years of age who is driving a motor vehicle and the officer has reasonable cause to believe that the person has a blood alcohol content of 0.01 or more, the officer shall request that the person take a PAS test to determine the presence of alcohol in the person, if a PAS test device is immediately available. If a PAS test device is not immediately available, the officer may request the person to submit to chemical testing of the person's blood, breath, or urine, conducted pursuant to Vehicle Code § 23612 (Vehicle Code § 13388).

If the person refuses to take or fails to complete the PAS test or other chemical test, or if the result of either test reveals a blood alcohol content of 0.01 or more, the officer shall proceed to serve the person with a notice of order of suspension pursuant to this policy (Vehicle Code § 13388).

504.6 REFUSALS

When an arrestee refuses to provide a viable chemical sample, officers should:

- (a) Advise the arrestee of the requirement to provide a sample (Vehicle Code § 23612).
- (b) Audio- and/or video-record the admonishment when it is practicable.
- (c) Document the refusal in the appropriate report.
- (d) Acquire a Search Warrant (McNeely) (Penal Code 1524).

504.6.1 BLOOD SAMPLE WITHOUT CONSENT

A blood sample may be obtained from a person who refuses a chemical test when any of the following conditions exist:

- (a) A search warrant has been obtained (Penal Code § 1524).
- (b) The officer can articulate that exigent circumstances exist. Exigency does not exist solely because of the short time period associated with the natural dissipation of alcohol or controlled or prohibited substances in the person's bloodstream. Exigency can be established by the existence of special facts such as a lengthy time delay in obtaining a blood sample due to an accident investigation or medical treatment of the person.

504.6.2 FORCED BLOOD SAMPLE

If an arrestee indicates by word or action that the person will physically resist a blood draw, the officer should request a supervisor to respond.

The responding supervisor should:

- (a) Evaluate whether using force to obtain a blood sample is appropriate under the circumstances.

Culver City Police Department

Culver City PD Policy Manual

Impaired Driving

- (b) Ensure that all attempts to obtain a blood sample through force cease if the person agrees to, and completes a viable form of testing in a timely manner.
- (c) Advise the person of the person's duty to provide a sample (even if this advisement was previously done by another officer) and attempt to persuade the individual to submit to such a sample without physical resistance.
 - 1. This dialogue should be recorded on audio and/or video if practicable.
- (d) Ensure that the blood sample is taken in a medically approved manner.
- (e) Ensure the forced blood draw is recorded on audio and/or video when practicable.
- (f) Monitor and ensure that the type and level of force applied appears reasonable under the circumstances:
 - 1. Unless otherwise provided in a warrant, force should generally be limited to handcuffing or similar restraint methods.
 - 2. In misdemeanor cases, if the arrestee becomes violent or more resistant, no additional force will be used and a refusal should be noted in the report.
 - 3. In felony cases, force which reasonably appears necessary to overcome the resistance to the blood draw may be permitted.
- (g) Ensure the use of force and methods used to accomplish the collection of the blood sample are documented in the related report.

If a supervisor is unavailable, officers are expected to use sound judgment and perform as a responding supervisor, as set forth above.

504.6.3 STATUTORY NOTIFICATIONS UPON REFUSAL

Upon refusal to submit to a chemical test as required by law, officers shall personally serve the notice of order of suspension upon the arrestee and take possession of any state-issued license to operate a motor vehicle that is held by that individual (Vehicle Code § 23612(e); Vehicle Code § 23612(f)).

504.7 ADMINISTRATIVE HEARINGS

The Traffic Investigator will ensure that all appropriate reports and documents related to administrative license suspensions are reviewed and forwarded to DMV.

Any officer who receives notice of required attendance to an administrative license suspension hearing should promptly notify the Traffic Investigator.

An officer called to testify at an administrative hearing should document the hearing date and DMV file number in a supplemental report. Specific details of the hearing generally should not be included in the report unless errors, additional evidence or witnesses are identified.

504.8 TRAINING

The Personnel and Training Lieutenant should ensure that officers participating in the enforcement of DUI laws receive regular training. Training should include, at minimum, current laws on impaired driving, investigative techniques and rules of evidence pertaining to DUI investigations. The

Culver City Police Department

Culver City PD Policy Manual

Impaired Driving

Personnel and Training Lieutenant should confer with the prosecuting attorney's office and update training topics as needed.

504.9 ARREST AND INVESTIGATION

504.9.1 WARRANTLESS ARREST

In addition to the arrest authority granted to officers pursuant to Penal Code § 836, an officer may make a warrantless arrest of a person that the officer has reasonable cause to believe has been driving under the influence of an alcoholic beverage or any drug, or under the combined influence of the same when (Vehicle Code § 40300.5):

- (a) The person is involved in a traffic crash.
- (b) The person is observed in or about a vehicle that is obstructing the roadway.
- (c) The person will not be apprehended unless immediately arrested.
- (d) The person may cause injury to themselves or damage property unless immediately arrested.
- (e) The person may destroy or conceal evidence of a crime unless immediately arrested.

504.9.2 OFFICER RESPONSIBILITIES

The officer serving the arrested person with a notice of an order of suspension shall immediately (Vehicle Code § 23612):

- (a) Forward a copy of the completed notice of suspension or revocation form and any confiscated driver's license to the Department of Motor Vehicles (DMV).
- (b) Forward a sworn report to DMV that contains the required information in Vehicle Code § 13380.
- (c) Forward the results to the appropriate forensic laboratory if the person submitted to a blood or urine test.

Traffic Citations

505.1 PURPOSE AND SCOPE

This policy outlines the responsibility for traffic citations, the procedure for dismissal, correction, and voiding of traffic citations.

505.1.1 CITATION COMPLETION

All employees are required to list their last name and employee serial number on all citations.

505.2 RESPONSIBILITIES

The Traffic Lieutenant shall be responsible for the development and design of all Department traffic citations in compliance with state law and the Judicial Council.

The Records Section shall be responsible for the supply and accounting of all traffic citations issued to employees of this department.

505.3 DISMISSAL OF TRAFFIC CITATIONS

Employees of this department do not have the authority to dismiss a citation once it has been issued. Only the court has the authority to dismiss a citation that has been issued (Vehicle Code § 40500(d)). Any request from a recipient to dismiss a citation shall be referred to the Traffic Section Manager. Upon a review of the circumstances involving the issuance of the traffic citation, the Traffic Section Manager may request the Operations Bureau Commander to recommend dismissal of the traffic citation. If approved, the citation will be forwarded to the appropriate court with a request for dismissal. All recipients of traffic citations whose request for the dismissal of a traffic citation has been denied shall be referred to the appropriate court.

Should an officer determine during a court proceeding that a traffic citation should be dismissed in the interest of justice or where prosecution is deemed inappropriate the officer may request the court to dismiss the citation.

505.4 VOIDING TRAFFIC CITATIONS

Voiding a traffic citation may occur when a traffic citation has not been completed or where it is completed, but not issued. All copies of the citation shall be presented to a supervisor to approve the voiding of the citation. The citation and copies shall then be forwarded to the Traffic Bureau.

505.5 CORRECTION OF TRAFFIC CITATIONS

When a traffic citation is issued and in need of correction, the officer issuing the citation shall submit the citation and a citation correction form requesting a specific correction to the Records Section. The Records Section shall prepare a letter of correction to the court having jurisdiction.

505.6 DISPOSITION OF TRAFFIC CITATIONS

The court and file copies of all traffic citations issued by members of this department shall be forwarded to the employee's immediate supervisor for review. The citation copies shall then be filed with the Records Section.

Culver City Police Department

Culver City PD Policy Manual

Traffic Citations

Upon separation from employment with this department, all employees issued traffic citation books shall return any unused citations to the Records Section.

505.7 NOTICE OF PARKING VIOLATION APPEAL PROCEDURE

Disposition of notice of parking violation appeals is conducted pursuant to Vehicle Code § 40215.

505.7.1 APPEAL STAGES

Appeals may be pursued sequentially at three different levels (Vehicle Code § 40215; Vehicle Code § 40230):

- (a) Administrative reviews are conducted by the Traffic Bureau who will review written/documentary data. Requests for administrative reviews are available at the front desk or Traffic Bureau of the Culver City Police Department. These requests are informal written statements outlining why the notice of parking violation should be dismissed. Copies of documentation relating to the notice of parking violation and the request for dismissal must be mailed to the current mailing address of the processing agency.
- (b) If the appellant wishes to pursue the matter beyond administrative review, an administrative hearing may be conducted in person or by written application, at the election of the appellant. Independent referees review the existent administrative file, amendments, and/or testimonial material provided by the appellant and may conduct further investigation or follow-up on their own.
- (c) If the appellant wishes to pursue the matter beyond an administrative hearing, a Superior Court review may be presented in person by the appellant after an application for review and designated filing fees have been paid to the Superior Court of California.

505.7.2 TIME REQUIREMENTS

Administrative review or appearance before a hearing examiner will not be provided if the mandated time limits are not adhered to by the violator.

- (a) Requests for an administrative review must be postmarked within 21 calendar days of issuance of the notice of parking violation, or within 14 calendar days of the mailing of the Notice of Delinquent Parking Violation (Vehicle Code § 40215(a)).
- (b) Requests for administrative hearings must be made no later than 21 calendar days following the notification mailing of the results of the administrative review (Vehicle Code § 40215(b)).
- (c) An administrative hearing shall be held within 90 calendar days following the receipt of a request for an administrative hearing, excluding time tolled pursuant to Vehicle Code § 40200 - 40225. The person requesting the hearing may request one continuance, not to exceed 21 calendar days (Vehicle Code § 40215).
- (d) Registered owners of vehicles may transfer responsibility for the violation via timely affidavit of non-liability when the vehicle has been transferred, rented or under certain other circumstances (Vehicle Code § 40209; Vehicle Code § 40210).

505.7.3 COSTS

- (a) There is no cost for an administrative review.

Culver City Police Department

Culver City PD Policy Manual

Traffic Citations

- (b) Appellants must deposit the full amount due for the citation before receiving an administrative hearing, unless the person is indigent, as defined in Vehicle Code § 40220, and provides satisfactory proof of inability to pay (Vehicle Code § 40215).
- (c) An appeal through Superior Court requires prior payment of filing costs, including applicable court charges and fees. These costs will be reimbursed to the appellant in addition to any previously paid fines if appellant's liability is overruled by the Superior Court.

505.8 JUVENILE CITATIONS

Completion of traffic citation forms for juveniles may vary slightly from the procedure for adults. The juvenile's age, place of residency, and the type of offense should be considered before issuing the juvenile a citation.

72-Hour Parking Violations

506.1 PURPOSE AND SCOPE

This policy provides procedures for the marking, recording, and storage of vehicles parked in violation of the Culver City City Ordinance regulating 72-hour parking violations and abandoned vehicles under the authority of Vehicle Code § 22669.

506.2 MARKING VEHICLES

Vehicles suspected of being in violation of the City of Culver City 72-Hour Parking Ordinance shall be electronically marked and noted on the Culver City Police Department A.V. Follow-Up Card. No case number is required.

Vehicles suspected of being in violation of the 72-Hour Parking Ordinance should be visibly marked by chalk and shall be electronically entered into the handheld ticketing device to show both the chalk mark and the position of the tire stem and to start the electronic timer. The street side front or rear tire may be chalk marked on the tire tread and so noted electronically. All markings, location, license plate, follow up date, and officer name shall be noted on the A.V. Follow Up. The investigating employee should make a good faith effort to notify the owner of any vehicle subject to towing prior to having the vehicle removed. This may be accomplished by personal contact, telephone or by leaving notice or parking citation attached to the vehicle at least 24 hours prior to removal.

All A.V. Follow Up Cards shall be submitted to the Traffic Section for maintenance until the follow-up is complete.

After 72-hours if the tire stem has not moved, the vehicle may be cited. Noted on the citation shall be a notice of a 24-hour period in which the vehicle will be towed if not moved from the location.

If a marked vehicle has been moved from the space during the 72-hour investigation period, the vehicle may be marked again with new electronic markings and the timing will begin anew.

506.2.1 MARKED VEHICLE FILE

The Traffic Bureau shall be responsible for maintaining a file for all active A.V. Follow-Up Cards.

Parking control officers assigned to the Traffic Section shall be responsible for the follow up investigation of all 72-hour parking violations noted on the A.V. Follow-Up Cards.

506.2.2 VEHICLE STORAGE

Any vehicle in violation shall be stored by the authorized towing service and a vehicle storage report shall be completed by the officer authorizing the storage of the vehicle.

The storage report form shall be submitted to the Records Section immediately following the storage of the vehicle. It shall be the responsibility of the Records Section to immediately notify the Stolen Vehicle System (SVS) of the Department of Justice in Sacramento (Vehicle Code § 22851.3(b)). Notification may also be made to the National Law Enforcement Telecommunications System (NLETS)(Vehicle Code § 22854.5).

Culver City Police Department

Culver City PD Policy Manual

72-Hour Parking Violations

Within 48 hours of the storage of any such vehicle, excluding weekends and holidays, it shall be the responsibility of the Records Section to determine the names and addresses of any individuals having an interest in the vehicle through DMV or CLETS computers. Notice to all such individuals shall be sent first-class or certified mail pursuant to Vehicle Code § 22851.3(d).

Disabled Vehicles

507.1 PURPOSE AND SCOPE

Vehicle Code § 20018 provides that all law enforcement agencies having responsibility for traffic enforcement may develop and adopt a written policy to provide assistance to motorists in disabled vehicles within their primary jurisdiction.

507.2 OFFICER RESPONSIBILITY

When an on-duty officer observes a disabled vehicle on the roadway, the officer should make a reasonable effort to provide assistance. If that officer is assigned to a call of higher priority, the dispatcher should be advised of the location of the disabled vehicle and the need for assistance. The dispatcher should then assign another available officer to respond for assistance as soon as practical.

507.3 EXTENT OF ASSISTANCE

In most cases, a disabled motorist will require assistance. After arrangements for assistance are made, continued involvement by department personnel will be contingent on the time of day, the location, the availability of departmental resources, and the vulnerability of the disabled motorist.

507.3.1 MECHANICAL REPAIRS

Department personnel shall not make mechanical repairs to a disabled vehicle. The use of push bumpers to relocate vehicles to a position of safety is not considered a mechanical repair.

507.3.2 RELOCATION OF DISABLED VEHICLES

The relocation of disabled vehicles by members of this department by pushing or pulling a vehicle should only occur when the conditions reasonably indicate that immediate movement is necessary to reduce a hazard presented by the disabled vehicle.

507.3.3 RELOCATION OF DISABLED MOTORIST

The relocation of a disabled motorist should only occur with the person's consent and should be suggested when conditions reasonably indicate that immediate movement is necessary to mitigate a potential hazard. The department member may stay with the disabled motorist or transport him/her to a safe area to await pickup.

507.4 PUBLIC ACCESS TO THIS POLICY

This written policy is available upon request.

Chapter 6 - Investigation Operations

Investigation and Prosecution

600.1 PURPOSE AND SCOPE

The purpose of this policy is to set guidelines and requirements pertaining to the handling and disposition of criminal investigations.

600.2 CASE CLEARANCE

The Investigations Bureau has the primary responsibility for managing and recording the clearance rate for crime incidents. Once a criminal case is assigned to a detective and a determination is made that the crime can be "Cleared," that information is entered into Mark 43. The data accumulated in Mark 43 is later extracted by the Department's Records Unit and then reported to the Department of Justice for inclusion in the Uniform Crime Reporting (UCR) System. The Special Operations Bureau Lieutenant is ultimately responsible for ensuring the proper reporting of data to the Department of Justice.

600.2.1 CLEARANCE RATE CRITERIA

The criteria the Criminal Investigations Division uses to clear a crime are based on guidelines established by the U.S. Department of Justice ("Uniform Crime Reporting Handbook"). Crimes are essentially cleared in one of three ways:

- (a) Unfounded complaints
- (b) Clearance by arrest
- (c) Exceptional clearance

600.2.2 UNFOUNDED COMPLAINTS

If an incident is investigated and it is determined that the facts do not substantiate a crime, the offense can be classified as "Unfounded." For instance, if a citizen reports a burglary, but the investigation determines that the victim lied or a cohabitant had made entry to retrieve his/her own property, then there is no basis for a crime and the case is cleared as "Unfounded."

600.2.3 CLEARANCE BY ARREST

An offense is "Solved" or "Cleared by Arrest" when at least one person is: arrested, charged with the commission of the crime, and turned over to the court system for prosecution.

In the event one person is responsible for multiple crimes, a clearance is logged for each crime that the same person committed. Conversely, only one clearance is logged if a crime involves multiple offenders.

Although no physical arrest is made, a "Clearance by Arrest" can be claimed when:

- (a) An offender (adult or juvenile) is issued a citation to appear before the Court or
- (b) A prosecuting agency issues an arrest warrant for the offender and the offender turns himself/herself over to a prosecuting authority.

Culver City Police Department

Culver City PD Policy Manual

Investigation and Prosecution

It should be noted that "Clearance by Arrest" is applicable only in cases where the suspect is arrested AND charged with a crime. If the prosecuting agency "rejects" the case for filing, then the crime cannot be classified as a "Clearance by Arrest." It may, however, meet the criteria for an "Exceptional Clearance."

600.2.4 EXCEPTIONAL CLEARANCE

In certain situations, detectives are not able to follow the three steps described above under "Clearance by Arrest." However, a crime may still be cleared as "Exceptional," provided the following applies:

- (a) The identity of the offender is known
- (b) There is enough evidence to support an arrest, criminal filing and prosecution
- (c) The location of the offender is known
- (d) For reasons outside of law enforcement's control, there are extenuating circumstances precluding detectives from arresting, charging, and prosecuting the offender

Although there can be a myriad of circumstances that fall under this category, some of the more common examples include the following:

- Offender is deceased
- Offender is prosecuted by another agency (such as in another State or by a Federal agency)
- Extradition is denied
- Deathbed confession (offender dies after confessing to a crime)
- A juvenile offender's case is handled through "counseling" or other administrative means
- Victim(s) and/or witness(es) refuse to cooperate in the prosecution
- Case matches Modus Operandi (MO) of other cases for which there was an arrest made

600.2.5 CASE LOAD MANAGEMENT

Each detective is responsible for the management of his/her respective assigned cases. There are many factors that can determine the number of active (open) cases a detective may have at any given time. Generally, detectives should manage their caseload so that investigations are conducted in a timely and effective manner. Detectives should routinely evaluate the status of their active cases, utilizing creative and efficient methods to conduct and complete investigations. Detectives should consider suspending cases that lack any investigative leads, as this will enable detectives to direct their time, attention, and resources to cases with more solvability factors.

Investigations Bureau Supervisors are responsible for actively monitoring and overseeing the effectiveness of detectives under their supervision. On a regular basis (which is determined by the needs of the specific investigative assignment), supervisors shall review appropriate reports

Culver City Police Department

Culver City PD Policy Manual

Investigation and Prosecution

available through RMS to determine if their respective detectives are effectively conducting investigations, solving crimes, and are adequately managing their caseload. When necessary, supervisors will provide guidance and implement appropriate corrective measures to assist detectives in meeting their caseload obligations.

600.2.6 MODIFICATION OF CHARGES

Employees are not authorized to recommend to the District Attorney, City Attorney, or to any other official of the court that charges on a pending case be altered or the case dismissed. In all cases resulting in court prosecution, any request to modify the charges filed or to recommend dismissal of charges in a pending case shall be made to the District Attorney's Office or City Attorney's Office only as authorized by a Bureau Commander or the Chief of Police.

600.3 POLICY

It is the policy of the Culver City Police Department to investigate crimes thoroughly and with due diligence, and to evaluate and prepare criminal cases for appropriate clearance or submission to a prosecutor.

600.4 CUSTODIAL INTERROGATION REQUIREMENTS

Suspects who are in custody and subjected to an interrogation shall be given the *Miranda* warning, unless an exception applies. Interview or interrogation of a juvenile shall be in accordance with the Temporary Custody of Juveniles Policy.

600.4.1 AUDIO/VIDEO RECORDINGS

Any custodial interrogation of an individual who is suspected of having committed any violent felony offense should be recorded (audio or video with audio as available) in its entirety. Every reasonable effort should be made to secure functional recording equipment to accomplish such recordings.

Consideration should also be given to recording a custodial interrogation, or any investigative interview, for any other offense when it is reasonable to believe it would be appropriate and beneficial to the investigation and is otherwise allowed by law.

No recording of a custodial interrogation should be destroyed or altered without written authorization from the prosecuting attorney and the Detective Bureau supervisor. Copies of recorded interrogations or interviews may be made in the same or a different format as the original recording, provided the copies are true, accurate and complete and are made only for authorized and legitimate law enforcement purposes.

Recordings should not take the place of a thorough report and investigative interviews. Written statements from suspects should continue to be obtained when applicable.

600.4.2 MANDATORY RECORDING OF ADULTS

Any custodial interrogation of an adult who is suspected of having committed any murder shall be recorded in its entirety. The recording should be video with audio if reasonably feasible (Penal Code § 859.5).

Culver City Police Department

Culver City PD Policy Manual

Investigation and Prosecution

This recording is not mandatory when (Penal Code § 859.5):

- (a) Recording is not feasible because of exigent circumstances that are later documented in a report.
- (b) The suspect refuses to have the interrogation recorded, including a refusal any time during the interrogation, and the refusal is documented in a report. If feasible, the refusal shall be electronically recorded.
- (c) The custodial interrogation occurred in another state by law enforcement officers of that state, unless the interrogation was conducted with the intent to avoid the requirements of Penal Code § 859.5.
- (d) The interrogation occurs when no member conducting the interrogation has a reason to believe that the individual may have committed murder. Continued custodial interrogation concerning that offense shall be electronically recorded if the interrogating member develops a reason to believe the individual committed murder.
- (e) The interrogation would disclose the identity of a confidential informant or would jeopardize the safety of an officer, the individual being interrogated or another individual. Such circumstances shall be documented in a report.
- (f) A recording device fails despite reasonable maintenance and the timely repair or replacement is not feasible.
- (g) The questions are part of a routine processing or booking, and are not an interrogation.
- (h) The suspect is in custody for murder and the interrogation is unrelated to a murder. However, if any information concerning a murder is mentioned during the interrogation, the remainder of the interrogation shall be recorded.

The Department shall maintain an original or an exact copy of the recording until a conviction relating to the interrogation is final and all appeals are exhausted or prosecution is barred by law (Penal Code § 859.5).

600.5 INITIAL INVESTIGATION

600.5.1 OFFICER RESPONSIBILITIES

An officer responsible for an initial investigation shall complete no less than the following:

- (a) Make a preliminary determination of whether a crime has been committed by completing, at a minimum:
 - 1. An initial statement from any witnesses or complainants.
 - 2. A cursory examination for evidence.
- (b) If information indicates a crime has occurred, the officer shall:
 - 1. Preserve the scene and any evidence as required to complete the initial and follow-up investigation.
 - 2. Determine if additional investigative resources (e.g., investigators or scene processing) are necessary and request assistance as required.

Culver City Police Department

Culver City PD Policy Manual

Investigation and Prosecution

3. If assistance is warranted, or if the incident is not routine, notify a supervisor or the Watch Commander.
 4. Make reasonable attempts to locate, identify and interview all available victims, complainants, witnesses and suspects.
 5. Collect any evidence.
 6. Take any appropriate law enforcement action.
 7. Complete and submit the appropriate reports and documentation.
- (c) If the preliminary determination is that no crime occurred, determine what other action may be necessary, what other resources may be available, and advise the informant or complainant of this information.

600.6 DISCONTINUATION OF INVESTIGATIONS

The investigation of a criminal case or efforts to seek prosecution should only be discontinued if one of the following applies:

- (a) All reasonable investigative efforts have been exhausted, no reasonable belief that the person who committed the crime can be identified, and the incident has been documented appropriately.
- (b) The perpetrator of a misdemeanor has been identified and a warning is the most appropriate disposition.
 1. In these cases, the investigator shall document that the person was warned and why prosecution was not sought.
 2. Warnings shall not be given for felony offenses or other offenses identified in this policy or by law that require an arrest or submission of a case to a prosecutor.
- (c) The case has been submitted to the appropriate prosecutor but no charges have been filed. Further investigation is not reasonable nor has the prosecutor requested further investigation.
- (d) The case has been submitted to the appropriate prosecutor, charges have been filed, and further investigation is not reasonable, warranted, or requested, and there is no need to take the suspect into custody.
- (e) Suspects have been arrested, there are no other suspects, and further investigation is either not warranted, or requested.
- (f) Investigation has proven that a crime was not committed (see the Sexual Assault Investigations Policy for special considerations in these cases).

The Domestic Violence, Child Abuse Sexual Assault Investigations, and Senior and Disability Victimization policies may also require an arrest or submittal of a case to a prosecutor.

600.7 COMPUTERS AND DIGITAL EVIDENCE

The collection, preservation, transportation and storage of computers, cell phones and other digital devices may require specialized handling to preserve the value of the related evidence. If it is anticipated that computers or similar equipment will be seized, officers should request that

Culver City Police Department

Culver City PD Policy Manual

Investigation and Prosecution

computer forensic examiners assist with seizing computers and related evidence. If a forensic examiner is unavailable, officers should take reasonable steps to prepare for such seizure and use the resources that are available.

600.8 INVESTIGATIVE USE OF SOCIAL MEDIA AND INTERNET SOURCES

Use of social media and any other internet source to access information for the purpose of criminal investigation shall comply with applicable laws and policies regarding privacy, civil rights, and civil liberties. Information gathered via the internet should only be accessed by members while on-duty and for purposes related to the mission of this department. If a member encounters information relevant to a criminal investigation while off-duty or while using the member's own equipment, the member should note the dates, times, and locations of the information and report the discovery to the member's supervisor as soon as practicable. The member, or others who have been assigned to do so, should attempt to replicate the finding when on-duty and using department equipment.

Information obtained via the internet should not be archived or stored in any manner other than department-established record keeping systems (see the Records Maintenance and Release and the Criminal Organizations policies).

600.8.1 INTERCEPTING ELECTRONIC COMMUNICATION

Intercepting social media communications in real time may be subject to federal and state wiretap laws. Officers should seek legal counsel before any such interception.

600.9 CELLULAR COMMUNICATIONS INTERCEPTION TECHNOLOGY

The Investigations Bureau Bureau Commander is responsible for ensuring the following for cellular communications interception technology operations (Government Code § 53166):

- (a) Security procedures are developed to protect information gathered through the use of the technology.
- (b) A usage and privacy policy is developed that includes:
 1. The purposes for which using cellular communications interception technology and collecting information is authorized.
 2. Identification by job title or other designation of employees who are authorized to use or access information collected through the use of cellular communications interception technology.
 3. Training requirements necessary for those authorized employees.
 4. A description of how the Department will monitor the use of its cellular communications interception technology to ensure the accuracy of the information collected and compliance with all applicable laws.
 5. Process and time period system audits.
 6. Identification of the existence of any memorandum of understanding or other agreement with any other local agency or other party for the shared use of cellular communications interception technology or the sharing of information collected through its use, including the identity of signatory parties.

Culver City Police Department

Culver City PD Policy Manual

Investigation and Prosecution

7. The purpose of, process for and restrictions on the sharing of information gathered through the use of cellular communications interception technology with other local agencies and persons.
8. The length of time information gathered through the use of cellular communications interception technology will be retained, and the process the local agency will utilize to determine if and when to destroy retained information.

Members shall only use approved devices and usage shall be in compliance with department security procedures, the department's usage and privacy procedures and all applicable laws.

600.10 USE OF CERTAIN DNA SAMPLES

Known samples of DNA collected from a victim of a crime or alleged crime, and known reference samples of DNA from any individual that were voluntarily provided for the purpose of exclusion are to be used only for the purpose directly related to the incident being investigated and in compliance with the procedures identified in Penal Code § 679.12.

600.11 ANTI-REPRODUCTIVE RIGHTS CRIMES

A member should take a report any time a person living within the jurisdiction of the Culver City Police Department reports that the person has been a victim of an anti-reproductive rights crime as defined by Penal Code § 13776 and Penal Code § 423.3. This includes:

- (a) Taking a report, even if the location of the crime is outside the jurisdiction of this department or has not been determined (e.g., online harassment).
- (b) Providing the victim with the appropriate information, as set forth in the Victim and Witness Assistance Policy. Members should encourage the person to review the material and should assist with any questions.

A report should also be taken if a person living outside department jurisdiction reports an anti-reproductive rights crime that may have been committed or facilitated within this jurisdiction (e.g., use of a post office box in the [city/county] to facilitate the crime).

A member investigating an anti-reproductive rights crime should ensure that the case is referred to the appropriate agency if it is determined that this department should not be the investigating agency. The victim should be advised that the case is being transferred to the agency of jurisdiction. The appropriate entries should be made into any databases that have been authorized for department use and are specific to this type of investigation.

The Detective Bureau supervisor should provide the Records Supervisor with enough information regarding the number of calls for assistance and number of arrests to meet the reporting requirements to the California Department of Justice as required by Penal Code § 13777. See the Records Section Policy for additional guidance.

600.12 STATE REQUIREMENTS FOR FIREARM INVESTIGATIONS

Culver City Police Department

Culver City PD Policy Manual

Investigation and Prosecution

600.12.1 CALIFORNIA DOJ NOTICE OF LOCATION OF REPORTED LOST OR STOLEN FIREARM

When notification is received from the California Department of Justice (DOJ) that a firearm purchase matches an entry made into the Automated Firearms System by the Department as lost or stolen, the Detective Bureau supervisor shall assign an officer to retrieve the firearm and book the firearm into evidence in accordance with the Property and Evidence Policy. Recovery of the firearm shall be reported pursuant to Penal Code § 11108.2, Penal Code §11108.3, and Penal Code § 11108.5. If appropriate, arrangements may be made to have another state or local law enforcement agency retrieve the firearm on behalf of the Department (Penal Code § 28220).

600.12.2 RELINQUISHMENT OF FIREARMS VERIFICATION

The Detective Bureau supervisor shall designate a member to have access to the Armed Prohibited Persons System (APPS) to receive information regarding individuals in the jurisdiction of the Department who have become a prohibited possessor of a firearm registered in their name and have not provided proof of relinquishment. The member shall document steps taken to verify that the individual is no longer in possession of firearms and provide the information to the Records Section for preparation of a quarterly report to the California DOJ (Penal Code § 29813) (see the Records Section Policy for additional guidance).

Senior Lead Detective

601.1 PURPOSE AND SCOPE

The Chief of Police or designee may appoint investigators to the position of Senior Lead Detective. The purpose of this policy is to establish the duties, responsibilities, and role of those assigned to the position of Senior Lead Detective.

601.2 DUTIES AND RESPONSIBILITIES

The Chief of Police or designee may appoint one detective from the Adult Section to Adult Senior Lead Detective and one detective from the Juvenile Section to Juvenile Senior Lead Detective. Although training new detectives will be the collective responsibility of all investigators and supervisors, Senior Lead Detectives will be expected to play a significant role in the training and serve as a resource for all detectives.

601.3 TERM DURATION

The Senior Lead Detective is a five year assignment. At the sole discretion of the Chief of Police or designee, the term of the Senior Lead Detective may be extended. The extended term will enable the Senior Lead Detectives to enhance their expertise and foster professional relationships with others that might serve as an investigative resource.

The Senior Lead Detective position is of a temporary duration, not a separate job classification, does not have civil service status, and is not subject to civil service selection procedure, appeal, or seniority. It is not a property right and may be revoked by the Chief of Police or designee at any time for job-related reasons or operational necessity.

Sexual Assault Investigations

602.1 PURPOSE AND SCOPE

The purpose of this policy is to establish guidelines for the investigation of sexual assaults. These guidelines will address some of the unique aspects of such cases and the effects that these crimes have on the victims.

Mandatory notifications requirements are addressed in the Child Abuse and Senior and Disability Victimization policies.

602.1.1 DEFINITIONS

Definitions related to this policy include:

Sexual assault - Any crime or attempted crime of a sexual nature, to include but not limited to offenses defined in Penal Code § 243.4, Penal Code § 261 et seq., and Penal Code § 285 et seq.

Sexual Assault Response Team (SART) - A multidisciplinary team generally comprised of advocates; law enforcement officers; forensic medical examiners, including sexual assault forensic examiners (SAFEs) or sexual assault nurse examiners (SANEs) if possible; forensic laboratory personnel; and prosecutors. The team is designed to coordinate a broad response to sexual assault victims.

602.2 POLICY

It is the policy of the Culver City Police Department that its members, when responding to reports of sexual assaults, will strive to minimize the trauma experienced by the victims, and will aggressively investigate sexual assaults, pursue expeditious apprehension and conviction of perpetrators, and protect the safety of the victims and the community.

602.3 QUALIFIED INVESTIGATORS

Qualified investigators should be available for assignment of sexual assault investigations. These investigators should:

- (a) Have specialized training in, and be familiar with, interview techniques and the medical and legal issues that are specific to sexual assault investigations.
- (b) Conduct follow-up interviews and investigation.
- (c) Present appropriate cases of alleged sexual assault to the prosecutor for review.
- (d) Coordinate with other enforcement agencies, social service agencies and medical personnel as needed.
- (e) Provide referrals to therapy services, victim advocates and support for the victim.
- (f) Participate in or coordinate with SART.

Culver City Police Department

Culver City PD Policy Manual

Sexual Assault Investigations

602.4 REPORTING

In all reported or suspected cases of sexual assault, a report should be written and assigned for follow-up investigation. This includes incidents in which the allegations appear unfounded or unsubstantiated.

602.5 RELEASING INFORMATION TO THE PUBLIC

In cases where the perpetrator is not known to the victim, and especially if there are multiple crimes where more than one appear to be related, consideration should be given to releasing information to the public whenever there is a reasonable likelihood that doing so may result in developing helpful investigative leads. The Detective Bureau supervisor should weigh the risk of alerting the suspect to the investigation with the need to protect the victim and the public, and to prevent more crimes.

602.6 TRAINING

Subject to available resources, periodic training should be provided to:

- (a) Members who are first responders. Training should include:
 1. Initial response to sexual assaults.
 2. Legal issues.
 3. Victim advocacy.
 4. Victim's response to trauma.
 5. Proper use and handling of the California standardized SAFE kit (Penal Code § 13823.14).
- (b) Qualified investigators, who should receive advanced training on additional topics. Advanced training should include:
 1. Interviewing sexual assault victims.
 2. SART.
 3. Medical and legal aspects of sexual assault investigations.
 4. Serial crimes investigations.
 5. Use of community and other federal and state investigative resources, such as the Violent Criminal Apprehension Program (ViCAP).
 6. Techniques for communicating with victims to minimize trauma.

602.7 VICTIM INTERVIEWS

The primary considerations in sexual assault investigations, which begin with the initial call to Southbay RCC, should be the health and safety of the victim, the preservation of evidence, and preliminary interviews to determine if a crime has been committed and to attempt to identify the suspect.

Whenever possible, a member of SART should be included in the initial victim interviews. An in-depth follow-up interview should not be conducted until after the medical and forensic

Culver City Police Department

Culver City PD Policy Manual

Sexual Assault Investigations

examinations are completed and the personal needs of the victim have been met (e.g., change of clothes, bathing). The follow-up interview may be delayed to the following day based upon the circumstances. Whenever practicable, the follow-up interview should be conducted by a qualified investigator.

No opinion of whether the case is unfounded shall be included in the report.

Victims shall not be asked or required to take a polygraph examination (34 USC § 10451; Penal Code § 637.4).

Victims should be apprised of applicable victim's rights provisions, as outlined in the Victim and Witness Assistance Policy.

602.7.1 VICTIM RIGHTS

Whenever there is an alleged sexual assault, the assigned officer shall accomplish the following:

- (a) Prior to the commencement of the initial interview, advise the victim in writing of the right to have a victim advocate and a support person of the victim's choosing present at any interview or contact by law enforcement, about any other rights of a sexual assault victim pursuant to the sexual assault victim card described in Penal Code § 680.2, and the right to have a person of the same or opposite gender present in the room during any interview with a law enforcement official unless no such person is reasonably available (Penal Code § 679.04).
- (b) If the victim is transported to a hospital for any medical evidentiary or physical examination, the officer shall immediately cause the local rape victim counseling center to be notified (Penal Code § 264.2).
 1. The officer shall not discourage a victim from receiving a medical evidentiary or physical examination (Penal Code § 679.04).
 2. A support person may be excluded from the examination by the officer or the medical provider if the support person's presence would be detrimental to the purpose of the examination (Penal Code § 264.2).

602.7.2 VICTIM CONFIDENTIALITY

Officers investigating or receiving a report of an alleged sex offense shall inform the victim, or the victim's parent or guardian if the victim is a minor, that his/her name will become a matter of public record unless the victim requests that his/her name not be made public. The reporting officer shall document in his/her report that the victim was properly informed and shall include any related response made by the victim, or if a minor, any response made by the victim's parent or guardian (Penal Code § 293).

Except as authorized by law, members of this department shall not publicly disclose the name of any victim of a sex crime who has exercised his/her right to confidentiality (Penal Code § 293).

602.8 COLLECTION AND TESTING OF BIOLOGICAL EVIDENCE

Whenever possible, a SART member should be involved in the collection of forensic evidence from the victim.

Culver City Police Department

Culver City PD Policy Manual

Sexual Assault Investigations

When the facts of the case indicate that collection of biological evidence is warranted, it should be collected regardless of how much time has elapsed since the reported assault.

If a drug-facilitated sexual assault is suspected, urine and blood samples should be collected from the victim as soon as practicable.

Subject to requirements set forth in this policy, biological evidence from all sexual assault cases, including cases where the suspect is known by the victim, should be submitted for testing.

Victims who choose not to assist with an investigation, do not desire that the matter be investigated, or wish to remain anonymous may still consent to the collection of evidence under their control. In these circumstances, the evidence should be collected and stored appropriately (Penal Code § 680).

602.8.1 COLLECTION AND TESTING REQUIREMENTS

Members investigating a sexual assault offense should take every reasonable step to ensure that DNA testing of such evidence is performed in a timely manner and within the time periods prescribed by Penal Code § 803(g). SAFE kits should be submitted to the crime lab within 20 days after being booked into evidence (Penal Code § 680).

In order to maximize the effectiveness of such testing and identify the perpetrator of any sexual assault, the assigned officer shall ensure that an information profile for the SAFE kit evidence has been created in the California Department of Justice (DOJ) SAFE-T database within 120 days of collection and should further ensure that the results of any such test have been timely entered into and checked against both the DOJ Cal-DNA database and the Combined DNA Index System (CODIS) (Penal Code § 680.3).

If the assigned officer determines that a SAFE kit submitted to a private vendor laboratory for analysis has not been tested within 120 days after submission, the officer shall update the SAFE-T database to reflect the reason for the delay in testing. The assigned officer shall continue to update the status every 120 days thereafter until the testing is complete, the statute of limitations has run, or the SAFE kit is exempt from the update requirement (Penal Code § 680.3).

If, for any reason, DNA evidence in a sexual assault case in which the identity of the perpetrator is in issue and is not going to be analyzed within 18 months of the crime, the assigned officer shall notify the victim of such fact in writing no less than 60 days prior to the expiration of the 18-month period (Penal Code § 680).

Additional guidance regarding evidence retention and destruction is found in the Property and Evidence Policy.

602.8.2 DNA TEST RESULTS

A SART member should be consulted regarding the best way to deliver biological testing results to a victim so as to minimize victim trauma, especially in cases where there has been a significant delay in getting biological testing results (e.g., delays in testing the evidence or delayed DNA databank hits). Members should make reasonable efforts to assist the victim by providing available

Culver City Police Department

Culver City PD Policy Manual

Sexual Assault Investigations

information on local assistance programs and organizations as provided in the Victim and Witness Assistance Policy.

- (a) Upon receipt of a written request from a sexual assault victim or the victim's authorized designee, members investigating sexual assault cases shall inform the victim of the status of the DNA testing of any evidence from the victim's case (Penal Code § 680).
 - 1. Although such information may be communicated orally, the assigned officer should thereafter follow-up with and retain a copy of confirmation by either written or electronic mail.
 - 2. Absent a written request, no member of this department is required to, but may, communicate with the victim or the victim's authorized designee regarding the status of any DNA testing.
- (b) Sexual assault victims shall further have the following rights (Penal Code § 680):
 - 1. To be informed if a DNA profile of the assailant was obtained from the testing of the SAFE kit or other crime scene evidence from their case.
 - 2. To be informed if there is a confirmed match between the DNA profile of the assailant developed from the evidence and a DNA profile contained in the DOJ Convicted Offender DNA Database, providing that disclosure would not impede or compromise an ongoing investigation.
 - 3. To be informed if the DNA profile of the assailant developed from the evidence has been entered into the DOJ Databank or the federal Department of Justice or Federal Bureau of Investigation CODIS database of case evidence.
 - 4. To access the DOJ SAFE-T database portal consistent with Penal Code § 680.3(e) for information involving their own forensic kit and the status of the kit.
- (c) Provided that the sexual assault victim or the victim's authorized designee has kept the assigned officer informed with regard to current address, telephone number, and email address (if available), any victim or the victim's authorized designee shall, upon request, be advised of any known significant changes regarding the victim's case (Penal Code § 680).
 - 1. Although such information may be communicated orally, the assigned officer should thereafter follow-up with and retain a copy of confirmation by either written or electronic mail.
 - 2. No officer shall be required or expected to release any information which might impede or compromise any ongoing investigation.

602.8.3 COLLECTION OF DNA REFERENCE SAMPLES

Reference samples of DNA collected directly from a victim of sexual assault, and reference samples of DNA collected from any individual that were voluntarily provided for the purpose of exclusion, shall be protected as provided in Penal Code § 679.12 (Penal Code § 680).

Culver City Police Department

Culver City PD Policy Manual

Sexual Assault Investigations

602.9 DISPOSITION OF CASES

If the assigned investigator has reason to believe the case is without merit, the case may be classified as unfounded only upon review and approval of the Special Operation Bureau supervisor.

Classification of a sexual assault case as unfounded requires the Special Operations Bureau supervisor to determine that the facts have significant irregularities with reported information and that the incident could not have happened as it was reported. When a victim has recanted his/her original statement, there must be corroborating evidence that the allegations were false or baseless (i.e., no crime occurred) before the case should be determined as unfounded.

602.10 CASE REVIEW

The Special Operations Bureau supervisor should ensure case dispositions are reviewed on a periodic basis, at least annually, using an identified group that is independent of the investigation process. The reviews should include an analysis of:

- Case dispositions.
- Decisions to collect biological evidence.
- Submissions of biological evidence for lab testing.

The SART and/or victim advocates should be considered for involvement in this audit. Summary reports on these reviews should be forwarded through the chain of command to the Chief of Police.

Asset Forfeiture

603.1 PURPOSE AND SCOPE

This policy describes the authority and procedure for the seizure, forfeiture and liquidation of property associated with designated offenses.

603.1.1 DEFINITIONS

Definitions related to this policy include:

Fiscal agent - The person designated by the Chief of Police to be responsible for securing and maintaining seized assets and distributing any proceeds realized from any forfeiture proceedings. This includes any time the Culver City Police Department seizes property for forfeiture or when the Culver City Police Department is acting as the fiscal agent pursuant to a multi-agency agreement.

Forfeiture - The process by which legal ownership of an asset is transferred to a government or other authority.

Forfeiture reviewer - The department member assigned by the Chief of Police who is responsible for reviewing all forfeiture cases and for acting as the liaison between the Department and the assigned attorney.

Property subject to forfeiture - The following may be subject to forfeiture:

- (a) Property related to a narcotics offense, which includes (Heath and Safety Code § 11470; Health and Safety Code § 11470.1):
 1. Property (not including real property or vehicles) used, or intended for use, as a container for controlled substances, materials to manufacture controlled substances, etc.
 2. Interest in a vehicle (car, boat, airplane, other vehicle) used to facilitate the manufacture, possession for sale or sale of specified quantities of controlled substances.
 3. Money, negotiable instruments, securities or other things of value furnished or intended to be furnished by any person in exchange for a controlled substance, proceeds traceable to an exchange, etc.
 4. Real property when the owner is convicted of violating Health and Safety Code § 11366, Health and Safety Code § 11366.5 or Health and Safety Code § 11366.6 (drug houses) when the property was not used as a family residence or for other lawful purposes, or property owned by two or more persons, one of whom had no knowledge of its unlawful use.
 5. The expenses of seizing, eradicating, destroying or taking remedial action with respect to any controlled substance or its precursors upon conviction for the unlawful manufacture or cultivation of any controlled substance or its precursors.

Culver City Police Department

Culver City PD Policy Manual

Asset Forfeiture

- (b) Property related to criminal profiteering (may include gang crimes), to include (Penal Code § 186.2; Penal Code § 186.3):
 - 1. Any property interest, whether tangible or intangible, acquired through a pattern of criminal profiteering activity.
 - 2. All proceeds acquired through a pattern of criminal profiteering activity, including all things of value that may have been received in exchange for the proceeds immediately derived from the pattern of criminal profiteering activity.

Seizure - The act of law enforcement officials taking property, cash or assets that have been used in connection with or acquired by specified illegal activities.

603.2 POLICY

The Culver City Police Department recognizes that appropriately applied forfeiture laws are helpful to enforce the law, deter crime and reduce the economic incentive of crime. However, the potential for revenue should never compromise the effective investigation of criminal offenses, officer safety or any person's due process rights.

It is the policy of the Culver City Police Department that all members, including those assigned to internal or external law enforcement task force operations, shall comply with all state and federal laws pertaining to forfeiture.

603.3 ASSET SEIZURE

Property may be seized for forfeiture as provided in this policy.

603.3.1 PROPERTY SUBJECT TO SEIZURE

The following may be seized upon review and approval of a supervisor and in coordination with the forfeiture reviewer:

- (a) Property subject to forfeiture authorized for seizure under the authority of a search warrant or court order.
- (b) Property subject to forfeiture not authorized for seizure under the authority of a search warrant or court order when any of the following apply (Health and Safety Code § 11471; Health and Safety Code § 11488):
 - 1. The property subject to forfeiture is legally seized incident to an arrest.
 - 2. There is probable cause to believe that the property was used or is intended to be used in a violation of the Uniform Controlled Substances Act and the seizing officer can articulate a nexus between the property and the controlled substance offense that would lead to the item being property subject for forfeiture.

Officers aware of assets that may be forfeitable as a result of criminal profiteering or human trafficking should consider contacting the district attorney regarding a court order to protect the assets (Penal Code § 186.6; Penal Code § 236.6).

Culver City Police Department

Culver City PD Policy Manual

Asset Forfeiture

Whenever practicable, a search warrant or court order for seizure prior to making a seizure is the preferred method.

A large amount of money standing alone is insufficient to establish the probable cause required to make a seizure.

603.3.2 PROPERTY NOT SUBJECT TO SEIZURE

The following property should not be seized for forfeiture:

- (a) Cash and property that does not meet the forfeiture counsel's current minimum forfeiture thresholds should not be seized.
- (b) Real property is not subject to seizure, absent exigent circumstances, without a court order (Health and Safety Code § 11471).
- (c) A vehicle which may be lawfully driven on the highway if there is a community property interest in the vehicle by a person other than the suspect and the vehicle is the sole vehicle available to the suspect's immediate family (Health and Safety Code § 11470).
- (d) Vehicles, boats or airplanes owned by an "innocent owner," such as a common carrier with no knowledge of the suspected offense (Health and Safety Code § 11490).
- (e) Any property when the associated activity involves the possession of marijuana or related paraphernalia that is permissible under the Control, Regulate and Tax Adult Use of Marijuana Act (Health and Safety Code § 11362.1).

603.3.3 SEIZED VEHICLES

Vehicles seized subject to forfeiture will be taken to a designated secure storage facility. A seized vehicle should not be impounded. The officer seizing the vehicle shall notify the detective supervisor of the seizure of the vehicle and circumstances of the seizure as soon as possible.

If the vehicle cannot be driven, a tow truck will be used to tow the vehicle to the storage facility.

Personal property located in a seized vehicle shall be removed and booked into Property as either evidence or for safekeeping.

603.4 PROCESSING SEIZED PROPERTY FOR FORFEITURE PROCEEDINGS

When property or cash subject to this policy is seized, the officer making the seizure should ensure compliance with the following:

- (a) Complete applicable seizure forms and present the appropriate copy to the person from whom the property is seized. If cash or property is seized from more than one person, a separate copy must be provided to each person, specifying the items seized. When property is seized and no one claims an interest in the property, the officer must leave the copy in the place where the property was found, if it is reasonable to do so.
- (b) Complete and submit a report and original seizure forms within 24 hours of the seizure, if practicable.

Culver City Police Department

Culver City PD Policy Manual

Asset Forfeiture

- (c) Forward the original seizure forms and related reports to the forfeiture reviewer within two days of seizure.

The officer will book seized property as evidence with the notation in the comment section of the property form, "Seized Subject to Forfeiture." Property seized subject to forfeiture should be booked on a separate property form. No other evidence from the case should be booked on this form.

Photographs should be taken of items seized, particularly cash, jewelry and other valuable items.

Officers who suspect property may be subject to seizure but are not able to seize the property (e.g., the property is located elsewhere, the whereabouts of the property is unknown, it is real estate, bank accounts, non-tangible assets) should document and forward the information in the appropriate report to the forfeiture reviewer.

603.5 MAINTAINING SEIZED PROPERTY

The Property and Evidence Section Supervisor is responsible for ensuring compliance with the following:

- (a) All property received for forfeiture is reasonably secured and properly stored to prevent waste and preserve its condition.
- (b) All property received for forfeiture is checked to determine if the property has been stolen.
- (c) All property received for forfeiture is retained in the same manner as evidence until forfeiture is finalized or the property is returned to the claimant or the person with an ownership interest.
- (d) Property received for forfeiture is not used unless the forfeiture action has been completed.

603.6 FORFEITURE REVIEWER

The Chief of Police will appoint an officer as the forfeiture reviewer. Prior to assuming duties, or as soon as practicable thereafter, the forfeiture reviewer should attend a department-approved course on asset forfeiture.

The responsibilities of the forfeiture reviewer include:

- (a) Remaining familiar with forfeiture laws, particularly Health and Safety Code § 11469 et seq. and Penal Code § 186.2 et seq. and the forfeiture policies of the forfeiture counsel.
- (b) Serving as the liaison between the Department and the forfeiture counsel and ensuring prompt legal review of all seizures.
- (c) Making reasonable efforts to obtain annual training that includes best practices in pursuing, seizing and tracking forfeitures.

Culver City Police Department

Culver City PD Policy Manual

Asset Forfeiture

- (d) Ensuring that property seized under state law is not referred or otherwise transferred to a federal agency seeking the property for federal forfeiture as prohibited by Health and Safety Code § 11471.2.
- (e) Ensuring that responsibilities, including the designation of a fiscal agent, are clearly established whenever multiple agencies are cooperating in a forfeiture case.
- (f) Ensuring that seizure forms are available and appropriate for department use. These should include notice forms, a receipt form and a checklist that provides relevant guidance to officers. The forms should be available in languages appropriate for the region and should contain spaces for:
 - 1. Names and contact information for all relevant persons and law enforcement officers involved.
 - 2. Information as to how ownership or other property interests may have been determined (e.g., verbal claims of ownership, titles, public records).
 - 3. A space for the signature of the person from whom cash or property is being seized.
 - 4. A tear-off portion or copy, which should be given to the person from whom cash or property is being seized, that includes the legal authority for the seizure, information regarding the process to contest the seizure and a detailed description of the items seized.
- (g) Ensuring that officers who may be involved in asset forfeiture receive training in the proper use of the seizure forms and the forfeiture process. The training should be developed in consultation with the appropriate legal counsel and may be accomplished through traditional classroom education, electronic media, Daily Training Bulletins (DTBs) or Department Directives. The training should cover this policy and address any relevant statutory changes and court decisions.
- (h) Reviewing each asset forfeiture case to ensure that:
 - 1. Written documentation of the seizure and the items seized is in the case file.
 - 2. Independent legal review of the circumstances and propriety of the seizure is made in a timely manner.
 - 3. Notice of seizure has been given in a timely manner to those who hold an interest in the seized property (Health and Safety Code § 11488.4).
 - 4. Property is promptly released to those entitled to its return (Health and Safety Code § 11488.2).
 - 5. All changes to forfeiture status are forwarded to any supervisor who initiates a forfeiture case.
 - 6. Any cash received is deposited with the fiscal agent.

Culver City Police Department

Culver City PD Policy Manual

Asset Forfeiture

7. Assistance with the resolution of ownership claims and the release of property to those entitled is provided.
8. Current minimum forfeiture thresholds are communicated appropriately to officers.
9. This policy and any related policies are periodically reviewed and updated to reflect current federal and state statutes and case law.
 - (i) Ensuring that a written plan that enables the Chief of Police to address any extended absence of the forfeiture reviewer, thereby ensuring that contact information for other law enforcement officers and attorneys who may assist in these matters is available.
 - (j) Ensuring that the process of selling or adding forfeited property to the department's regular inventory is in accordance with all applicable laws and consistent with the department's use and disposition of similar property.
 - (k) Keeping a manual that details the statutory grounds for forfeitures and department procedures related to asset forfeiture, including procedures for prompt notice to interest holders, the expeditious release of seized property, where appropriate, and the prompt resolution of claims of innocent ownership (Heath and Safety Code § 11469).
 - (l) Providing copies of seized business records to the person or business from whom such records were seized, when requested (Heath and Safety Code §11471).
 - (m) Notifying the California Franchise Tax Board when there is reasonable cause to believe that the value of seized property exceeds \$5,000.00 (Health and Safety Code § 11471.5).

Forfeiture proceeds should be maintained in a separate fund or account subject to appropriate accounting control, with regular reviews or audits of all deposits and expenditures.

Forfeiture reporting and expenditures should be completed in the manner prescribed by the law and City financial directives (Health and Safety Code § 11495).

603.7 DISPOSITION OF FORFEITED PROPERTY

Forfeited funds distributed under Health and Safety Code § 11489 et seq. shall only be used for purposes allowed by law, but in no case shall a peace officer's employment or salary depend upon the level of seizures or forfeitures he/she achieves (Heath and Safety Code § 11469).

The Department may request a court order so that certain uncontaminated science equipment is relinquished to a school or school district for science classroom education in lieu of destruction (Health and Safety Code § 11473; Health and Safety Code § 11473.5).

603.7.1 RECEIVING EQUITABLE SHARES

When participating in a joint investigation with a federal agency, the Culver City Police Department shall not receive an equitable share from the federal agency of all or a portion of the forfeiture proceeds absent either a required conviction under Health and Safety Code § 11471.2 or the

Culver City Police Department

Culver City PD Policy Manual

Asset Forfeiture

flight, death or willful failure to appear of the defendant. This does not apply to forfeited cash or negotiable instruments of \$40,000 or more.

603.8 CLAIM INVESTIGATIONS

An investigation shall be made as to any claimant of a vehicle, boat or airplane whose right, title, interest or lien is on the record in the Department of Motor Vehicles or in an appropriate federal agency. If investigation reveals that any person, other than the registered owner, is the legal owner, and that ownership did not arise subsequent to the date and time of arrest or notification of the forfeiture proceedings or seizure of the vehicle, boat or airplane, notice shall be made to the legal owner at his/her address appearing on the records of the Department of Motor Vehicles or the appropriate federal agency (Health and Safety Code § 11488.4).

Informants

604.1 PURPOSE AND SCOPE

The purpose of this policy is to provide guidelines for the use of informants.

604.1.1 DEFINITIONS

Definitions related to this policy include:

Informant - A person who covertly interacts with other individuals or suspects at the direction of, request of, or by agreement with, the Culver City Police Department for law enforcement purposes. This also includes a person agreeing to supply information to the Culver City Police Department for a benefit (e.g., a quid pro quo in the form of a reduced criminal penalty, money).

604.2 POLICY

The Culver City Police Department recognizes the value of informants to law enforcement efforts and will strive to protect the integrity of the informant process. It is the policy of this department that all funds related to informant payments will be routinely audited and that payments to informants will be made according to the criteria outlined in this policy.

604.3 USE OF INFORMANTS

604.3.1 INITIAL APPROVAL

Before using an individual as an informant, an officer must receive approval from his/her supervisor. The officer shall compile sufficient information through a background investigation and experience with the informant in order to determine the suitability of the individual, including age, maturity and risk of physical harm, as well as any indicators of his/her reliability and credibility.

Members of this department should not guarantee absolute safety or confidentiality to an informant.

604.3.2 JUVENILE INFORMANTS

The use of informants under the age of 13 is prohibited.

Except for the enforcement of laws related to the commercial sale of alcohol, marijuana or tobacco products, a juvenile 13 years of age or older may only be used as an informant with the written consent of each of the following:

- (a) The juvenile's parents or legal guardians
- (b) The juvenile's attorney, if any
- (c) The court in which the juvenile's case is being handled, if applicable (Penal Code § 701.5)
- (d) The Chief of Police or the authorized designee

Culver City Police Department

Culver City PD Policy Manual

Informants

604.3.3 INFORMANT AGREEMENTS

All informants are required to sign and abide by the provisions of the designated department informant agreement. The officer using the informant shall discuss each of the provisions of the agreement with the informant.

Details of the agreement are to be approved in writing by a supervisor before being finalized with the informant.

604.4 INFORMANT INTEGRITY

To maintain the integrity of the informant process, the following must be adhered to:

- (a) The identity of an informant acting in a confidential capacity shall not be withheld from the Chief of Police, Bureau Commander, Investigations Bureau supervisor or their authorized designees.
 - 1. Identities of informants acting in a confidential capacity shall otherwise be kept confidential.
- (b) Criminal activity by informants shall not be condoned.
- (c) Informants shall be told they are not acting as police officers, employees or agents of the Culver City Police Department, and that they shall not represent themselves as such.
- (d) The relationship between department members and informants shall always be ethical and professional.
 - 1. Members shall not become intimately involved with an informant.
 - 2. Social contact shall be avoided unless it is necessary to conduct an official investigation, and only with prior approval of the Investigations Bureau supervisor.
 - 3. Members shall neither solicit nor accept gratuities or engage in any private business transaction with an informant.
- (e) Officers shall not meet with informants in a private place unless accompanied by at least one additional officer or with prior approval of the Investigations Bureau supervisor.
 - 1. Officers may meet informants alone in an occupied public place, such as a restaurant.
- (f) When contacting informants for the purpose of making payments, officers shall arrange for the presence of another officer.
- (g) In all instances when department funds are paid to informants, a voucher shall be completed in advance, itemizing the expenses.
- (h) Since the decision rests with the appropriate prosecutor, officers shall not promise that the informant will receive any form of leniency or immunity from criminal prosecution.

Culver City Police Department

Culver City PD Policy Manual

Informants

604.4.1 UNSUITABLE INFORMANTS

The suitability of any informant should be considered before engaging him/her in any way in a covert or other investigative process. Members who become aware that an informant may be unsuitable will notify the supervisor, who will initiate a review to determine suitability. Until a determination has been made by a supervisor, the informant should not be used by any member. The supervisor shall determine whether the informant should be used by the Department and, if so, what conditions will be placed on his/her participation or any information the informant provides. The supervisor shall document the decision and conditions in file notes and mark the file "unsuitable" when appropriate.

Considerations for determining whether an informant is unsuitable include, but are not limited to, the following:

- (a) The informant has provided untruthful or unreliable information in the past.
- (b) The informant behaves in a way that may endanger the safety of an officer.
- (c) The informant reveals to suspects the identity of an officer or the existence of an investigation.
- (d) The informant appears to be using his/her affiliation with this department to further criminal objectives.
- (e) The informant creates officer-safety issues by providing information to multiple law enforcement agencies simultaneously, without prior notification and approval of each agency.
- (f) The informant engages in any other behavior that could jeopardize the safety of officers or the integrity of a criminal investigation.
- (g) The informant commits criminal acts subsequent to entering into an informant agreement.

604.5 INFORMANT FILES

Informant files shall be utilized as a source of background information about the informant, to enable review and evaluation of information provided by the informant, and to minimize incidents that could be used to question the integrity of department members or the reliability of the informant.

Informant files shall be maintained in a secure area by the Investigations Bureau sergeant. The Investigations Bureau supervisor or the authorized designee shall be responsible for maintaining informant files. Access to the informant files shall be restricted to the Chief of Police, Bureau Commander, Investigations Bureau supervisor or their authorized designees.

The Investigations Bureau Bureau Commander should arrange for an audit using a representative sample of randomly selected informant files on a periodic basis, but no less than one time per year. If the Investigations Bureau supervisor is replaced, the files will be audited before the new supervisor takes over management of the files. The purpose of the audit is to ensure compliance with file content and updating provisions of this policy. The audit should be conducted by a supervisor who does not have normal access to the informant files.

Culver City Police Department

Culver City PD Policy Manual

Informants

604.5.1 FILE SYSTEM PROCEDURE

A separate file shall be maintained on each informant and shall be coded with an assigned informant control number. An informant history that includes the following information shall be prepared for each file:

- (a) Name and aliases
- (b) Date of birth
- (c) Physical description: sex, race, height, weight, hair color, eye color, scars, tattoos or other distinguishing features
- (d) Photograph
- (e) Current home address and telephone numbers
- (f) Current employers, positions, addresses and telephone numbers
- (g) Vehicles owned and registration information
- (h) Places frequented
- (i) Briefs of information provided by the informant and his/her subsequent reliability
 1. If an informant is determined to be unsuitable, the informant's file is to be marked "unsuitable" and notations included detailing the issues that caused this classification.
- (j) Name of the officer initiating use of the informant
- (k) Signed informant agreement
- (l) Update on active or inactive status of informant

604.6 INFORMANT PAYMENTS

No informant will be told in advance or given an exact amount or percentage for his/her service. The amount of funds to be paid to any informant will be evaluated against the following criteria:

- The extent of the informant's personal involvement in the case
- The significance, value or effect on crime
- The value of assets seized
- The quantity of the drugs or other contraband seized
- The informant's previous criminal activity
- The level of risk taken by the informant

The Investigations Bureau supervisor will discuss the above factors with the Operations Bureau Commander and recommend the type and level of payment subject to approval by the Chief of Police.

604.6.1 PAYMENT PROCESS

Approved payments to an informant should be in cash using the following process:

Culver City Police Department

Culver City PD Policy Manual

Informants

- (a) Payments of \$500 and under may be paid in cash from a Investigations Bureau buy/expense fund.
 - 1. The Investigations Bureau supervisor shall sign the voucher for cash payouts from the buy/expense fund.
- (b) Payments exceeding \$500 shall be made by issuance of a check, payable to the officer who will be delivering the payment.
 - 1. The check shall list the case numbers related to and supporting the payment.
 - 2. A written statement of the informant's involvement in the case shall be placed in the informant's file.
 - 3. The statement shall be signed by the informant verifying the statement as a true summary of his/her actions in the case.
 - 4. Authorization signatures from the Chief of Police and the City Council are required for disbursement of the funds.
- (c) To complete the payment process for any amount, the officer delivering the payment shall complete a cash transfer form.
 - 1. The cash transfer form shall include the following:
 - (a) Date
 - (b) Payment amount
 - (c) Culver City Police Department case number
 - (d) A statement that the informant is receiving funds in payment for information voluntarily rendered.
 - 2. The cash transfer form shall be signed by the informant.
 - 3. The cash transfer form will be kept in the informant's file.

604.6.2 REPORTING OF PAYMENTS

Each informant receiving a cash payment shall be advised of his/her responsibility to report the cash to the Internal Revenue Service (IRS) as income. If funds distributed exceed \$600 in any reporting year, the informant should be provided IRS Form 1099 (26 CFR 1.6041-1). If such documentation or reporting may reveal the identity of the informant and by doing so jeopardize any investigation, the safety of officers or the safety of the informant (26 CFR 1.6041-3), then IRS Form 1099 should not be issued.

In such cases, the informant shall be provided a letter identifying the amount he/she must report on a tax return as "other income" and shall be required to provide a signed acknowledgement of receipt of the letter. The completed acknowledgement form and a copy of the letter shall be retained in the informant's file.

Culver City Police Department

Culver City PD Policy Manual

Informants

604.6.3 AUDIT OF PAYMENTS

The Investigations Bureau supervisor or the authorized designee shall be responsible for compliance with any audit requirements associated with grant provisions and applicable state and federal law.

At least once every six months, the Chief of Police or the authorized designee should conduct an audit of all informant funds for the purpose of accountability and security of the funds. The funds and related documents (e.g., buy/expense fund records, cash transfer forms, invoices, receipts and logs) will assist with the audit process.

Terrorist Activity

605.1 PURPOSE AND SCOPE

The purpose of this policy to is establish a procedure for intelligence gathering, the sharing of information, and the tracking of terrorist activity.

605.1.1 TERRORIST LIAISON OFFICERS

As a collateral duty Department personnel, Terrorist Liaison Officers (TLO), shall be assigned to liaison with other government agencies whose purpose it is to asses intelligence information, determine the threat levels, and distribute intelligence. Based upon intelligence information, the response procedures will be implemented at the direction of department management.

Eyewitness Identification

606.1 PURPOSE AND SCOPE

This policy sets forth guidelines to be used when members of this department employ eyewitness identification techniques (Penal Code § 859.7).

606.1.1 DEFINITIONS

Definitions related to the policy include:

Eyewitness identification process - Any field identification, live lineup or photographic identification.

Field identification - A live presentation of a single individual to a witness following the commission of a criminal offense for the purpose of identifying or eliminating the person as the suspect.

Live lineup - A live presentation of individuals to a witness for the purpose of identifying or eliminating an individual as the suspect.

Photographic lineup - Presentation of photographs to a witness for the purpose of identifying or eliminating an individual as the suspect.

606.2 POLICY

The Culver City Police Department will strive to use eyewitness identification techniques, when appropriate, to enhance the investigative process and will emphasize identifying persons responsible for crime and exonerating the innocent.

606.3 INTERPRETIVE SERVICES

Members should make a reasonable effort to arrange for an interpreter before proceeding with eyewitness identification if communication with a witness is impeded due to language or hearing barriers.

Before the interpreter is permitted to discuss any matter with the witness, the investigating member should explain the identification process to the interpreter. Once it is determined that the interpreter comprehends the process and can explain it to the witness, the eyewitness identification may proceed as provided for within this policy.

606.4 EYEWITNESS IDENTIFICATION PROCESS AND FORM

The Detective Bureau supervisor shall be responsible for the development and maintenance of an eyewitness identification process for use by members when they are conducting eyewitness identifications.

The process should include appropriate forms or reports that provide (Penal Code § 859.7):

- (a) The date, time and location of the eyewitness identification procedure.
- (b) The name and identifying information of the witness.

Culver City Police Department

Culver City PD Policy Manual

Eyewitness Identification

- (c) The name of the person administering the identification procedure.
- (d) If applicable, the names of all of the individuals present during the identification procedure.
- (e) An instruction to the witness that it is as important to exclude innocent persons as it is to identify a perpetrator.
- (f) An instruction to the witness that the perpetrator may or may not be among those presented and that the witness is not obligated to make an identification.
- (g) If the identification process is a photographic or live lineup, an instruction to the witness that the perpetrator may not appear exactly as he/she did on the date of the incident.
- (h) An instruction to the witness that the investigation will continue regardless of whether an identification is made by the witness.
- (i) A signature line where the witness acknowledges that he/she understands the identification procedures and instructions.
- (j) A statement from the witness in the witness's own words describing how certain he/she is of the identification or non-identification. This statement should be taken at the time of the identification procedure.
- (k) Any other direction to meet the requirements of Penal Code § 859.7, including direction regarding blind or blinded administrations and filler selection.

The process and related forms should be reviewed at least annually and modified when necessary.

606.5 EYEWITNESS IDENTIFICATION

Members are cautioned not to, in any way, influence a witness as to whether any subject or photo presented in a lineup is in any way connected to the case.

Members should avoid mentioning that:

- The individual was apprehended near the crime scene.
- The evidence points to the individual as the suspect.
- Other witnesses have identified or failed to identify the individual as the suspect.

In order to avoid undue influence, witnesses should view suspects or a lineup individually and outside the presence of other witnesses. Witnesses should be instructed to avoid discussing details of the incident or of the identification process with other witnesses.

The eyewitness identification procedure should be audio and video recorded and the recording should be retained according to current evidence procedures. When it is not feasible to make a recording with both audio and visual representations, an audio recording should be made (Penal Code § 859.7).

606.6 DOCUMENTATION

A thorough description of the eyewitness process and the result of any eyewitness identification should be documented in the case report.

Culver City Police Department

Culver City PD Policy Manual

Eyewitness Identification

If a photographic lineup is utilized, a copy of the photographic lineup presented to the witness should be included in the case report. In addition, the order in which the photographs were presented to the witness should be documented in the case report.

606.6.1 DOCUMENTATION RELATED TO RECORDINGS

The handling member shall document the reason that a video recording or any other recording of an identification was not obtained (Penal Code § 859.7).

606.6.2 DOCUMENTATION RELATED TO BLIND ADMINISTRATION

If a presentation of a lineup is not conducted using blind administration, the handling member shall document the reason (Penal Code § 859.7).

606.7 PHOTOGRAPHIC LINEUP AND LIVE LINEUP CONSIDERATIONS

When practicable, the member presenting the lineup should not be involved in the investigation of the case or know the identity of the suspect. In no case should the member presenting a lineup to a witness know which photograph or person in the lineup is being viewed by the witness (Penal Code § 859.7). Techniques to achieve this include randomly numbering photographs, shuffling folders, or using a computer program to order the persons in the lineup.

Individuals in the lineup should reasonably match the description of the perpetrator provided by the witness and should bear similar characteristics to avoid causing any person to unreasonably stand out. In cases involving multiple suspects, a separate lineup should be conducted for each suspect. The suspects should be placed in a different order within each lineup (Penal Code § 859.7). The witness should view all persons in the lineup.

A live lineup should only be used before criminal proceedings have been initiated against the suspect. If there is any question as to whether any criminal proceedings have begun, the investigating member should contact the appropriate prosecuting attorney before proceeding. A live lineup may also be requested by either the prosecution or the defense once criminal proceedings have begun.

606.7.1 OTHER SAFEGUARDS

Witnesses should be asked for suspect descriptions as close in time to the incident as possible and before conducting an eyewitness identification. No information concerning a suspect should be given prior to obtaining a statement from the witness describing how certain he/she is of the identification or non-identification. Members should not say anything to a witness that may validate or invalidate an eyewitness' identification. In photographic lineups, writings or information concerning any previous arrest of a suspect shall not be visible to the witness (Penal Code § 859.7).

606.8 FIELD IDENTIFICATION CONSIDERATIONS

Field identifications, also known as field elimination show-ups or one-on-one identifications, may be helpful in cases where an alleged crime has been committed, officers have contacted and

Culver City Police Department

Culver City PD Policy Manual

Eyewitness Identification

detained a possible suspect(s), and victims and/or witnesses are available to either identify them or eliminate them as suspects in the crime.

When initiating a field identification, the member should observe the following guidelines:

- (a) Obtain a complete description of the suspect from the witness.
- (b) Assess whether a witness should be included in a field identification process by considering:
 - (a) The length of time the witness observed the suspect.
 - (b) The distance between the witness and the suspect.
 - (c) Whether the witness could view the suspect's face.
 - (d) The quality of the lighting when the suspect was observed by the witness.
 - (e) Whether there were distracting noises or activity during the observation.
 - (f) Any other circumstances affecting the witness's opportunity to observe the suspect.
 - (g) The length of time that has elapsed since the witness observed the suspect.
- (c) If safe and practicable, the person who is the subject of the show-up should not be handcuffed or in a patrol vehicle.
- (d) When feasible, members should bring the witness to the location of the subject of the show-up, rather than bring the subject of the show-up to the witness.
- (e) The person who is the subject of the show-up should not be shown to the same witness more than once.
- (f) In cases involving multiple suspects, witnesses should only be permitted to view the subjects of the show-up one at a time.
- (g) The person who is the subject of the show-up should not be required to put on clothing worn by the suspect, to speak words uttered by the suspect or to perform other actions mimicking those of the suspect.

Brady Material Disclosure

607.1 PURPOSE AND SCOPE

This policy establishes guidelines for identifying and releasing potentially exculpatory or impeachment information (so-called “*Brady* information”) to a prosecuting attorney.

607.1.1 DEFINITIONS

Definitions related to this policy include:

Brady information -Information known or possessed by the Culver City Police Department that is both favorable and material to the current prosecution or defense of a criminal defendant.

607.2 POLICY

The Culver City Police Department will conduct fair and impartial criminal investigations and will provide the prosecution with both incriminating and exculpatory evidence, as well as information that may adversely affect the credibility of a witness. In addition to reporting all evidence of guilt, the Culver City Police Department will assist the prosecution by complying with its obligation to disclose information that is both favorable and material to the defense. The Department will identify and disclose to the prosecution potentially exculpatory information, as provided in this policy.

607.3 DISCLOSURE OF INVESTIGATIVE INFORMATION

Officers must include in their investigative reports adequate investigative information and reference to all material evidence and facts that are reasonably believed to be either incriminating or exculpatory to any individual in the case. If an officer learns of potentially incriminating or exculpatory information any time after submission of a case, the officer or the handling investigator must prepare and submit a supplemental report documenting such information as soon as practicable. Supplemental reports shall be promptly processed and transmitted to the prosecutor’s office.

If information is believed to be privileged or confidential (e.g., confidential informant or attorney-client information, attorney work product), the officer should discuss the matter with a supervisor and/or prosecutor to determine the appropriate manner in which to proceed.

Evidence or facts are considered material if there is a reasonable probability that they would affect the outcome of a criminal proceeding or trial. Determining whether evidence or facts are material often requires legal or even judicial review. If an officer is unsure whether evidence or facts are material, the officer should address the issue with a supervisor.

Supervisors who are uncertain about whether evidence or facts are material should address the issue in a written memo to an appropriate prosecutor. A copy of the memo should be retained in the Department case file.

607.4 DISCLOSURE OF PERSONNEL INFORMATION

Whenever it is determined that *Brady* information is located in the personnel file of a member of this department who is a material witness in a criminal case, the following procedure shall apply:

Culver City Police Department

Culver City PD Policy Manual

Brady Material Disclosure

- (a) In the event that a *Pitchess* motion has not already been filed by the criminal defendant or other party pursuant to Evidence Code § 1043, the prosecuting attorney shall be notified of the potential presence of *Brady* information in the officer's personnel file.
- (b) The prosecuting attorney should then be requested to file a *Pitchess* motion in order to initiate an in-camera review by the court.
- (c) Any member who is the subject of such a motion shall be notified in writing that a motion has been filed.
- (d) The Custodian of Records shall accompany all relevant files during any in-camera inspection and address any issues or questions raised by the court in determining whether any information contained in the files is both material and favorable to the criminal defendant.
- (e) If the court determines that there is relevant *Brady* information contained in the files, only that information ordered released will be copied and released to the parties filing the motion.
 - 1. Prior to the release of any information pursuant to this process, the Custodian of Records should request a protective order from the court limiting the use of such information to the involved case and requiring the return of all copies upon completion of the case.

607.5 INVESTIGATING BRADY ISSUES

If the Department receives information from any source that a member may have issues of credibility, dishonesty or has been engaged in an act of moral turpitude or criminal conduct, the information shall be investigated and processed in accordance with the Personnel Complaints Policy.

607.6 TRAINING

Department members should receive periodic training on the requirements of this policy.

Warrant Service

608.1 PURPOSE AND SCOPE

This policy establishes guidelines for the planning and serving of arrest and search warrants by members of this department. It is understood that this policy cannot address every variable or circumstance that can arise in the service of a search or arrest warrant, as these tasks can involve rapidly evolving and unique circumstances.

This policy is intended to be used in conjunction with the Operations Planning and Deconfliction Policy, which has additional guidance on planning and serving high-risk warrants.

This policy is not intended to address the service of search warrants on locations or property already secured or routine field warrant arrests by patrol officers.

608.2 POLICY

It is the policy of the Culver City Police Department to balance the safety needs of the public, the safety of department members, privacy interests and other relevant factors when making decisions related to the service of search and arrest warrants.

608.3 WARRANT PREPARATION

An officer who prepares a warrant should ensure the documentation in support of the warrant contains as applicable:

- (a) Probable cause to support the search or arrest, including relevant dates and times to demonstrate timeliness and facts to support any request for nighttime or no-knock warrant execution.
- (b) A clear explanation of the affiant's training, experience, and relevant education.
- (c) Adequately supported opinions, when relevant, that are not left to unsubstantiated conclusions.
- (d) A nexus between the place to be searched and the persons or items central to the investigation. The facts supporting this nexus should be clear and current. For example, the affidavit shall explain why there is probable cause to believe that a particular person is currently residing at a particular location or that the items sought are present at a particular location.
- (e) Full disclosure of known or suspected residents at the involved location and any indication of separate living spaces at the involved location. For example, it should be disclosed that several people may be renting bedrooms at a single location, even if the exact location of the rooms is not known.
- (f) A specific description of the location to be searched, including photographs of the location, if reasonably available.
- (g) A sufficient description of the items to be seized.
- (h) Full disclosure of any known exculpatory information relevant to the warrant application (refer to the Brady Material Disclosure Policy).

Culver City Police Department

Culver City PD Policy Manual

Warrant Service

608.4 HIGH-RISK WARRANT SERVICE

The operations director or the authorized designee shall coordinate the service of warrants that are categorized as high risk and shall have sole authority in determining the manner in which the warrant will be served, including the number of officers deployed.

The member responsible for directing the service should ensure the following as applicable:

- (a) When practicable and when doing so does not cause unreasonable risk, video or photographic documentation is made of the condition of the location prior to execution of a search warrant. The images should include the surrounding area and persons present.
- (b) The warrant service is audio- and video-recorded when practicable and reasonable to do so.
- (c) Evidence is handled and collected only by those members who are designated to do so. All other members involved in the service of the warrant should alert one of the designated members to the presence of potential evidence and not touch or disturb the items.
- (d) Reasonable efforts are made during the search to maintain or restore the condition of the location.
- (e) Persons who are detained as part of the warrant service are handled appropriately under the circumstances.
- (f) Reasonable care provisions are made for children and dependent adults (see the Child and Dependent Adult Safety Policy).
- (g) A list is made of all items seized and a copy provided to the person in charge of the premises if present or otherwise left in a conspicuous place.
- (h) A copy of the search warrant is left at the location.
- (i) The condition of the property is documented with video recording or photographs after the search.

608.5 SUPERVISORY RESPONSIBILITY

It is the responsibility of the affiant detective's supervisor to review all search and arrest warrants prior to submission to a judge or magistrate for review. The supervisor should ensure that thorough work-ups are completed on suspects and target locations. Supervisors should ensure that a comprehensive briefing is completed prior to warrant service.

The on-scene supervisor(s) shall take reasonable steps to ensure that unoccupied dwellings/structures are secured prior to leaving the location. The on-scene supervisor(s) shall ensure that a copy of the warrant and a receipt for the property taken are left at the location. The on-scene supervisor(s) shall that damage caused during the warrant service is photographed and/or video recorded, and is documented on an officer's report and in the sergeant's log.

If a supervisor determines a warrant to be high risk, he/she shall confer with the Investigations Bureau Commander or the ERU Commander to determine the best course of action.

Culver City Police Department

Culver City PD Policy Manual

Warrant Service

The supervisor shall ensure that all affidavits, warrants, receipts and returns, regardless of any associated cases, are filed with the issuing judge or magistrate as soon as reasonably possible, in any event no later than any date specified on the warrant.

608.6 OUTSIDE AGENCIES AND CROSS-JURISDICTIONAL WARRANTS

The operations director will ensure that cooperative efforts with other agencies in the service of warrants conform to existing mutual aid agreements or other memorandums of understanding and will work cooperatively to mitigate risks including, but not limited to, the following:

- Identity of team members
- Roles and responsibilities
- Familiarity with equipment
- Rules of engagement
- Asset forfeiture procedures

Any outside agency requesting assistance in the service of a warrant within this jurisdiction should be referred to the operations director. The director should review and confirm the warrant, including the warrant location, and should discuss the service with the appropriate supervisor from the other agency. The director should ensure that members of the Culver City Police Department are utilized appropriately. Any concerns regarding the requested use of Culver City Police Department members should be brought to the attention of the Chief of Police or the authorized designee. The actual service of the warrant will remain the responsibility of the agency requesting assistance.

If the operations director is unavailable, the Watch Commander should assume this role.

If officers intend to serve a warrant outside Culver City Police Department jurisdiction, the operations director should provide reasonable advance notice to the applicable agency, request assistance as needed and work cooperatively on operational planning and the mitigation of risks detailed in this policy.

Officers will remain subject to the policies of the Culver City Police Department when assisting outside agencies or serving a warrant outside Culver City Police Department jurisdiction.

608.7 DOCUMENTATION

Documentation related to the service of a warrant shall be maintained in accordance with the established records retention schedule.

608.8 NO-KNOCK ENTRIES

No-knock entries are only authorized if a no-knock warrant has been obtained or if exigent circumstances arise at the scene such that knocking and announcing the officer's presence would create an imminent threat of physical violence to the officer or another person.

Facial Recognition

609.1 PURPOSE AND SCOPE

The purpose of this policy is to establish procedures for the acceptable use of the images (probe and candidate), information, and tools within the facial recognition system. Facial recognition shall only be used when there is reasonable suspicion that such use will provide information relevant to an active investigation, imminent threat to health or safety, or to help in the identification of deceased persons or persons unable to identify themselves. This policy applies to all Department personnel who are granted access to the facial recognition system as well as personnel who are permitted to request facial recognition searches

609.2 DEFINITIONS

Definitions related to this policy include:

Facial Recognition – The automated searching of a facial image (probe) against a database of facial images resulting in a list of possible candidates. This is commonly referred to as a "one-to-many comparison."

Facial Reviewer – The reviewer of a candidate list to identify possible matches.

Probe Image – The facial image searched against the gallery (facial images in database) in a facial recognition system.

Candidate – A possible match(es) to the submitted probe image.

609.3 POLICY

Facial recognition technology shall only be utilized as an investigative tool to assist Department personnel conducting active criminal investigations, while recognizing the established privacy rights of the public.

Potential matches returned by the facial recognition system are to be considered investigative leads only and shall not be used as the sole basis for an arrest or identification.

609.4 RESPONSIBILITIES

The Department and users shall ensure that use or access of facial recognition databases is in accordance with local, state, federal laws and this policy.

609.5 PERMITTED USE

Department personnel shall only use facial recognition:

- In conjunction with an active criminal investigation;
- In response to an imminent threat to health or safety;
- To help in the identification of deceased persons or persons unable to identify themselves;
- In adherence with local, state, and federal law, as well as Department policy;

Culver City Police Department

Culver City PD Policy Manual

Facial Recognition

- Only by appropriately trained personnel.

609.6 PROHIBITED OR RESTRICTED USES

Department personnel shall not use facial recognition for the following:

- To conduct random surveillance or monitor any members of the public through any camera or video device;
- In conjunction with portable recorders, including Unmanned Aerial Vehicles (UAV) or Unmanned Ground Vehicle (UGV/Robot);
- In conjunction with an officer's body worn camera or data collected from an officer's body worn camera. (PC 832.19(b)); or
- For any type of predictive analysis and/or profiling.

609.7 FIRST AMENDMENT ACTIVITY

Department personnel shall not perform or request facial recognition searches of individuals or organizations based solely on the following:

- Their religious, political, or social views or activities;
- Their participation in a particular non-criminal organization;
- Their race, ethnicity, citizenship, place of origin, age, disability, gender, gender identity, sexual orientation, or other classification protected by law.

Facial recognition must be used in accordance with all local, state, and federal laws, as well as Department policy.

609.8 DATABASE AND DATA LIMITATIONS

The Culver City Police Department, and Department personnel shall not maintain or keep any image database for the purpose of conducting facial recognition searches.

609.9 DOCUMENTATION

All facial recognition searches will require appropriate documentation to include:

- Date/time of search;
- Investigator conducting the search;
- Case report number or Incident number;
- Associated criminal offense code;
- Purpose of search;
- Supervisor notification.

With any close match where an investigative lead is generated, the investigator shall complete a detailed report on the information they received. Any facial recognition matches will be considered investigative leads only. Facial recognition shall not be used as the sole basis for an arrest or identification.

Culver City Police Department

Culver City PD Policy Manual

Facial Recognition

609.10 INVESTIGATIVE SEARCHES

Probe images shall only be used from legally obtained sources (i.e. consent, court order, or search warrant) and/or open-source data.

609.11 TRAINING

Department personnel accessing any facial recognition system shall be properly trained prior to utilizing any facial recognition system.

609.12 SUPERVISOR RESPONSIBILITIES & AUDITS

Supervisors shall ensure all Department use of any facial recognition system shall be performed on a need-to-know and right-to-know basis.

All Departmental use of any facial recognition system, including search requests, will be tracked and periodically audited by the Investigations Sergeant and/or Lieutenant. Audits will ensure all facial recognition searches have been conducted with appropriate justification in accordance with all local, state, and federal laws, as well as Department policy.

609.13 LOS ANGELES COUNTY REGIONAL IDENTIFICATION SYSTEM (LACRIS)

The Los Angeles County Regional Identification System (LACRIS) is the California Department of Justice's CAL-ID program responsible for providing biometric identification services to Los Angeles County law enforcement agencies.

The Digital Mugshot System (DMS) is the repository of all criminal booking photos (mugshots) and includes a facial recognition application. The DMS database is supported by a fingerprint comparison conducted by the California Department of Justice.

The use of LACRIS facial recognition system is controlled by state law pertaining to the Criminal Offender Record Information (CORI) system. Section 11075 of the California Penal Code defines CORI as: records and data compiled by criminal justice agencies for purposes of identifying criminal offenders and of maintaining as to each such offender a summary of arrests, pre-trial proceedings, the nature and disposition of criminal charges, sentencing, incarceration, rehabilitation, and release.

Forensic Genetic Genealogy

610.1 PURPOSE AND SCOPE

This policy provides guidance for the use of forensic genetic genealogy (FGG) to generate investigative leads.

610.1.1 DEFINITIONS

Definitions related to this policy include:

Combined DNA Index System (CODIS) - An FBI computer software program that operates deoxyribonucleic acid (DNA) profile databases for law enforcement use.

DNA typing laboratory - A laboratory that analyzes biological samples, including extracted DNA, in order to provide various DNA profile types. State or local crime labs are generally not equipped to provide single nucleotide polymorphism (SNP) DNA profiles; therefore, the use of private DNA typing laboratories is often necessary for FGG.

Extracted DNA - The DNA isolated from a biological sample remaining after previous DNA testing has been completed.

Forensic genetic genealogy (FGG) - The process of obtaining a SNP DNA profile from a biological sample collected during an investigation; uploading the profile to a genetic genealogy site for comparison to the consumer profiles in the site's database to identify genetic relatives; and using the identified genetic relationships, as well as traditional genealogy research, to generate investigative leads.

Genetic genealogist - A genealogist who uses DNA testing with traditional genealogical research methods to assist law enforcement or private clients in identifying biological relatives of an individual.

Genetic genealogy site - A database of DNA profiles voluntarily submitted by public consumers for the purpose of identifying genetic relatives. The availability of genetic genealogy sites for law enforcement use varies depending on their terms of service.

Short tandem repeat (STR) DNA profile - The results of DNA typing in a format that can be processed through CODIS and state DNA databases. This is the type of DNA used in conventional non-FGG law enforcement investigations.

Single nucleotide polymorphism (SNP) DNA profile - The results of DNA typing in a format that enables an unknown DNA sample to be compared to the DNA profiles maintained by a genetic genealogy site. This is the DNA type used in FGG.

610.2 POLICY

The Culver City Police Department's use of FGG will be in coordination with prosecutors, the Coroner, and other appropriate resources only in qualifying cases after reasonable conventional investigative methods have been pursued. Members will take reasonable steps to maintain the

Culver City Police Department

Culver City PD Policy Manual

Forensic Genetic Genealogy

integrity of the FGG process and safeguard the privacy rights of individuals whose DNA profiles are analyzed.

610.3 CRITERIA FOR FGG USE

Before using FGG, the lead investigator should coordinate with the supervisor to determine whether the case meets the following requirements:

- (a) Biological evidence collected as part of the underlying investigation (or extracted DNA from the biological evidence) is available for additional testing and is reasonably believed to be attributable to:
 - 1. The perpetrator of an unsolved violent felony.
 - 2. The unidentified human remains of a suspected homicide victim.
- (b) All reasonable conventional investigative methods have been utilized and all reasonable investigative leads have been pursued (e.g., relevant case information entered in the National Missing and Unidentified Persons System (NamUs) and the Violent Criminal Apprehension Program (ViCAP) national database).
- (c) An STR DNA profile has been developed from the biological evidence collected in the case and, absent unusual circumstances, has been uploaded to CODIS and any applicable state DNA database for comparison with negative results.

610.4 COORDINATION

Once a preliminary determination has been made that a case may qualify for the use of FGG, the lead investigating member should consult with the appropriate prosecutor to address current and prospective legal issues and determine if a search warrant is required.

In the case of unidentified human remains, the lead investigator should also consult with the Coroner.

610.5 SUBMISSION OF SAMPLE

The biological evidence or extracted DNA should be submitted to a DNA typing laboratory approved by the Department in order to obtain a SNP DNA profile.

Once a SNP DNA profile has been obtained from the biological evidence or extracted DNA, the lead investigating member should arrange for it to be compared to the SNP DNA profiles contained in one or more genetic genealogy sites to identify possible genetic relatives. The lead investigator should work with a qualified genetic genealogist as needed during this process.

When submitting a SNP DNA profile for comparison, the lead investigator or the authorized designee (e.g., assigned genetic genealogist) shall notify the genetic genealogy site that the request for comparison is from a law enforcement agency and confirm that the site's terms of service permit FGG for the type of case being investigated. The use of the SNP DNA profile and any subsequent comparison shall be limited to the original underlying investigation.

If at any time during the FGG process the case no longer meets the criteria for FGG use, the lead investigator should promptly notify the DNA typing laboratory, genetic genealogy site, and/or

Culver City Police Department

Culver City PD Policy Manual

Forensic Genetic Genealogy

genetic genealogist to cease any further analysis and to return all evidence, data, and materials to the Department.

610.6 ANALYSIS OF FGG DATA

Once results of a comparison are received from a genetic genealogy site, the information should be evaluated by a genetic genealogist, who will assist the lead investigator in identifying potential investigative leads.

The lead investigator should promptly and diligently pursue each viable lead identified through the FGG process using traditional investigative methods, as appropriate, to:

- (a) Eliminate an individual as a potential suspect in the case.
- (b) Link an individual to the case as a potential suspect.
- (c) Identify human remains.

610.7 COLLECTION OF THIRD-PARTY DNA SAMPLE

If it is determined that a third-party DNA sample (i.e., from a person not likely to be a suspect in the investigation) should be collected and analyzed for FGG, consent from the third party should be obtained prior to collection.

If there is a reasonable belief that the integrity of the investigation would be compromised by seeking consent from the third party prior to collection, the lead investigator should consult with the prosecutor regarding applicable laws and procedures in both the jurisdiction of the investigation and the jurisdiction where the collection will occur, if different.

The use of a third-party DNA sample shall be limited to the original underlying investigation.

610.8 POST-IDENTIFICATION

Members shall not rely solely on FGG identification of a potential suspect for probable cause to make an arrest or obtain an arrest warrant. Unless there is sufficient evidence independent of the FGG data to support an arrest, a potential suspect identified through FGG should not be arrested until the suspect's identity is confirmed.

Members shall not rely solely on FGG to identify human remains unless there is sufficient evidence independent of the FGG data to declare the identification or confirmation testing has been completed.

Confirmatory DNA testing should be conducted by collecting a known DNA sample from the potential suspect or, in the case of unidentified human remains, from a close biological relative. This known DNA sample should be submitted for comparison to the original unknown STR DNA profile through conventional methods (e.g., in CODIS).

The lead investigator should consult with the prosecutor to determine the appropriate method of obtaining a known DNA sample.

Once the identity of a suspect or the identity of unidentified human remains has been confirmed through conventional DNA testing, the lead investigator should:

Culver City Police Department

Culver City PD Policy Manual

Forensic Genetic Genealogy

- (a) Consult with the prosecutor to evaluate the entire investigative file for consideration of criminal charges or further investigation.
- (b) If applicable, consult with the Coroner for an amendment to a certificate of death.

610.9 PRIVACY CONSIDERATIONS

Members should make reasonable efforts to respect and protect the privacy of non-suspect genetic relatives identified through the FGG process. The names and identifying information of any non-suspect genetic relatives should not be included in official reports, probable cause declarations, or affidavits for search warrants and should not be disclosed unless otherwise required by law or court order.

The lead investigator should formally request that the SNP DNA profile be removed from all genetic genealogy sites upon identity confirmation and should retain a copy of the request for department records. The lead investigator should request that all case-related records and data provided to, or generated by, a genetic genealogist during the FGG process be returned to the Department.

610.10 RETENTION OF DNA SAMPLES AND RELATED RECORDS

Genetic information, including any derivative profiles and genetic genealogy site user information, should be retained in accordance with the established records retention schedule. The lead investigator should coordinate with the Property Technician and provide adequate notice to the appropriate prosecutor's office before destroying any profiles or data obtained from the FGG process.

See the Property and Evidence Policy for guidelines regarding biological evidence, including DNA samples.

Chapter 7 - Equipment

Department Owned and Personal Property

700.1 PURPOSE AND SCOPE

Department employees are expected to properly care for department property assigned or entrusted to them. Employees may also suffer occasional loss or damage to personal or department property while performing their assigned duty. Certain procedures are required depending on the loss and ownership of the item.

700.2 CARE OF DEPARTMENTAL PROPERTY

Employees shall be responsible for the safekeeping, serviceable condition, proper care, use and replacement of department property assigned or entrusted to them. An employee's intentional or negligent abuse or misuse of department property may lead to discipline including, but not limited to the cost of repair or replacement.

- (a) Employees shall promptly report through their chain of command, any loss, damage to, or unserviceable condition of any department issued property or equipment assigned for their use.
- (b) The use of damaged or unserviceable department property should be discontinued as soon as practical and replaced with comparable Department property as soon as available and following notice to a supervisor.
- (c) Except when otherwise directed by competent authority or required by exigent circumstances, department property should only be used by those to whom it was assigned. Use should be limited to official purposes and in the capacity for which it was designed.
- (d) Department property shall not be thrown away, sold, traded, donated, destroyed, or otherwise disposed of without proper authority.
- (e) In the event that any Department property becomes damaged or unserviceable, no employee shall attempt to repair the property without prior approval of a supervisor.

700.3 FILING CLAIMS FOR PERSONAL PROPERTY

Claims for reimbursement for damage or loss of personal property must be made on the proper form. This form is submitted to the employee's immediate supervisor. The supervisor may require a separate written report of the loss or damage.

The supervisor shall direct a memo to the appropriate Bureau Commander, which shall include the results of his/her investigation and whether the employee followed proper procedures. The supervisor's report shall address whether reasonable care was taken to prevent the loss or damage.

Upon review by staff and a finding that no misconduct or negligence was involved, repair or replacement may be recommended by the Chief of Police who will then forward the claim to the Finance Department.

Culver City Police Department

Culver City PD Policy Manual

Department Owned and Personal Property

The Department will not replace or repair luxurious or overly expensive items (jewelry, exotic equipment, etc.) that are not reasonably required as a part of work.

700.3.1 REPORTING REQUIREMENT

A verbal report shall be made to the employee's immediate supervisor as soon as circumstances permit.

A written report shall be submitted before the employee goes off duty or within the time frame directed by the supervisor to whom the verbal report is made.

700.4 LOSS OR DAMAGE OF PROPERTY OF ANOTHER

Officers and other employees intentionally or unintentionally may cause damage to the real or personal property of another while performing their duties. Any employee who damages or causes to be damaged any real or personal property of another while performing any law enforcement functions, regardless of jurisdiction, shall report it as provided below.

- (a) A verbal report shall be made to the employee's immediate supervisor as soon as circumstances permit.
- (b) A written report shall be submitted before the employee goes off duty or within the time frame directed by the supervisor to whom the verbal report is made.

700.4.1 DAMAGE BY PERSON OF ANOTHER AGENCY

If employees of another jurisdiction cause damage to real or personal property belonging to the City, it shall be the responsibility of the employee present or the employee responsible for the property to make a verbal report to his/her immediate supervisor as soon as circumstances permit. The employee shall submit a written report before going off duty or as otherwise directed by the supervisor.

These written reports, accompanied by the supervisor's written report, shall promptly be forwarded to the appropriate Bureau Commander.

Personal Communication Devices

701.1 PURPOSE AND SCOPE

The purpose of this policy is to establish guidelines for the use of mobile telephones and communication devices, whether issued or funded by the Department or personally owned, while on-duty or when used for authorized work-related purposes.

This policy generically refers to all such devices as Personal Communication Devices (PCDs) but is intended to include all mobile telephones, personal digital assistants (PDAs), wireless capable tablets and similar wireless two-way communications and/or portable Internet access devices. PCD use includes, but is not limited to, placing and receiving calls, text messaging, blogging and microblogging, emailing, using video or camera features, playing games and accessing sites or services on the Internet.

701.2 POLICY

The Culver City Police Department allows members to utilize department-issued or funded PCDs and to possess personally owned PCDs in the workplace, subject to certain limitations. Any PCD used while on- or off-duty for business-related purposes, or reasonably associated with work-related misconduct, will be subject to monitoring and inspection consistent with applicable law and this policy.

Additionally, the use of a PCD either on-duty or after duty hours for business-related purposes, or reasonably associated with work-related misconduct, may subject the member and the member's PCD records to civil or criminal discovery or disclosure under applicable public records laws.

Members who have questions regarding the application of this policy or the guidelines contained herein are encouraged to seek clarification from supervisory personnel.

701.3 PRIVACY EXPECTATION

Members forfeit any expectation of privacy with regard to any communication accessed, transmitted, received, or reviewed on any PCD issued or funded by the Department and shall have no expectation of privacy in their location should the device be equipped with location-detection capabilities. This includes records of all keystrokes or web-browsing history made on the PCD. The fact that access to a database, service, or website requires a username or password will not create an expectation of privacy if it is accessed through department PCDs or networks (see the Information Technology Use Policy for additional guidance).

Members have no expectation of privacy regarding any communications while using a personally owned PCD for department-related business or when the use reasonably implicates work-related misconduct.

701.3.1 CALIFORNIA ELECTRONIC COMMUNICATIONS PRIVACY ACT (CALECPA)

No member is authorized to be the sole possessor of a department-issued PCD. Department-issued PCDs can be retrieved, reassigned, accessed or used by any member as directed by a supervisor without notice. Member use of a department-issued PCD and use of a personal PCD at

Culver City Police Department

Culver City PD Policy Manual

Personal Communication Devices

work or for work-related business constitutes specific consent for access for department purposes. Prior to conducting an administrative search of a PCD, supervisors should consult legal counsel to ensure access is consistent with CalECPA (Penal Code § 1546; Penal Code § 1546.1).

701.4 DEPARTMENT-ISSUED PCD

Depending on a member's assignment and the needs of the position, the Department may, at its discretion, issue or fund a PCD for the member's use to facilitate on-duty performance. Department-issued or funded PCDs may not be used for personal business either on- or off-duty unless authorized by the Chief of Police or the authorized designee. Such devices and the associated telephone number, if any, shall remain the sole property of the Department and shall be subject to inspection or monitoring (including all related records and content) at any time without notice and without cause.

Unless a member is expressly authorized by the Chief of Police or the authorized designee for off-duty use of the PCD, the PCD will be either secured in the workplace at the completion of the tour of duty or turned off when leaving the workplace.

701.5 PROHIBITED USE

Members are allowed to use PCDs to photograph or audio/video record any department related business but should only be considered if a department camera and/or recording device is not reasonably available. Work related photographs and audio/video recordings should be uploaded via the Mark43 application on the department approved PCD.

701.6 USE WHILE DRIVING

The use of a PCD while driving can adversely affect safety, cause unnecessary distractions and present a negative image to the public. Officers operating emergency vehicles should restrict the use of these devices to matters of an urgent nature and should, where practicable, stop the vehicle at an appropriate location to use the PCD.

Members who are operating department vehicles that are not authorized emergency vehicles shall not use a PCD while driving unless the device is specifically designed and configured to allow hands-free use. In an emergency, a wireless phone may be used to place an emergency call to the Department or other emergency services agency (Vehicle Code § 23123; Vehicle Code § 23123.5). Hands-free use should be restricted to business-related calls or calls of an urgent nature.

701.7 OFFICIAL USE

Members are reminded that PCDs are not secure devices and conversations may be intercepted or overheard. Caution should be exercised while utilizing PCDs to ensure that sensitive information is not inadvertently transmitted. As soon as reasonably possible, members shall conduct sensitive or private communications on a land-based or other department communications network.

Vehicle Maintenance

702.1 PURPOSE AND SCOPE

Employees are responsible for assisting in maintaining Department vehicles so that they are properly equipped, properly maintained, properly refueled and present a clean appearance.

702.2 DEFECTIVE VEHICLES

When a department vehicle becomes inoperative or in need of repair that affects the safety of the vehicle, that vehicle shall be removed from service for repair. Proper documentation shall be promptly completed by the employee who first becomes aware of the defective condition, describing the correction needed. The paperwork shall be promptly forwarded to vehicle maintenance for repair.

702.2.1 SEVERE USE

Vehicles operated under severe-use conditions, which include operations for which the vehicle is not designed or that exceed the manufacturer's parameters, should be removed from service and subjected to a safety inspection as soon as practicable. Such conditions may include rough roadway or off-road driving, hard or extended braking, pursuits or prolonged high-speed operation.

702.2.2 REMOVAL OF WEAPONS

All firearms, weapons and control devices shall be removed from a vehicle and properly secured in the department armory prior to the vehicle being released for maintenance, service or repair.

702.3 VEHICLE EQUIPMENT

Certain items shall be maintained in all department vehicles for emergency purposes and to perform routine duties.

702.3.1 PATROL VEHICLES

Officers shall inspect the patrol vehicle at the beginning of the shift, if circumstances do not prohibit it, and ensure that the following equipment, at a minimum, is present in the vehicle:

- 20 Emergency road flares
- 2 Sticks yellow crayon or chalk
- 1 Roll Crime Scene Barricade Tape
- 1 CPR mask
- 2 Emergency blankets
- 1 Fire extinguisher
- 1 "spit" hood
- Face masks
- Protective gloves

Culver City Police Department

Culver City PD Policy Manual

Vehicle Maintenance

- Hand sanitizing wipes or gel
- Bandages
- Trauma bandages
- 2 Sharps biohazard containers
- Evidence collection bags

702.3.2 UNMARKED VEHICLES

An employee driving unmarked department vehicles shall, unless circumstances prohibit it, ensure that it is stocked with the necessary equipment to effectively perform their duties.

702.4 VEHICLE REFUELING

Absent emergency conditions or supervisor approval, officers driving patrol vehicles shall not place a vehicle in service that has less than one-half tank of fuel. Vehicles shall only be refueled at the authorized location.

702.5 WASHING OF VEHICLES

All units shall be kept clean at all times and weather conditions permitting, shall be washed as necessary to enhance their appearance.

Officers in patrol shall obtain clearance from the dispatcher before responding to the car wash. Only one marked unit should be at the car wash at the same time unless otherwise approved by a supervisor.

Employees using a vehicle shall remove any trash or debris at the end of their shift. Confidential material should be placed in a designated receptacle provided for the shredding of this matter.

702.6 CIVILIAN EMPLOYEE USE

Civilian employees using marked vehicles shall ensure all weapons are removed from vehicles before going into service. Civilian employees shall not operate the emergency lights or siren of any vehicle unless expressly authorized by a supervisor.

Vehicle Use

703.1 PURPOSE AND SCOPE

The purpose of this policy is to establish a system of accountability to ensure department vehicles are used appropriately. This policy provides guidelines for on- and off-duty use of department vehicles and shall not be construed to create or imply any contractual obligation by the City of Culver City to provide assigned take-home vehicles.

Additional guidelines for member responsibilities when transporting persons in custody may be found in the Transporting Persons in Custody Policy.

703.2 POLICY

The Culver City Police Department provides vehicles for department-related business and may assign patrol and unmarked vehicles based on a determination of operational efficiency, economic impact to the Department, requirements for tactical deployments, and other considerations.

703.3 USE OF VEHICLES

703.3.1 SHIFT ASSIGNED VEHICLES

The Watch Commander shall ensure a copy of the shift assignment roster indicating member assignments and vehicle numbers is completed for each shift and retained in accordance with the established records retention schedule. If a member exchanges vehicles during the member's shift, the new vehicle number shall be documented on the roster.

703.3.2 OTHER USE OF VEHICLES

Members utilizing a vehicle for any purpose other than their normally assigned duties or normal vehicle assignment (e.g., transportation to training, community event) shall first notify the Watch Commander and a notation will be made.

This subsection does not apply to those who are assigned to vehicle transportation duties to and from the maintenance yard or carwash.

703.3.3 INSPECTIONS

Members shall be responsible for inspecting the interior and exterior of any assigned vehicle before taking the vehicle into service and at the conclusion of their shifts. Any previously unreported damage, mechanical problems, unauthorized contents, or other problems with the vehicle shall be promptly reported to a supervisor and documented as appropriate.

The interior of any vehicle that has been used to transport any person other than a member of this department should be inspected prior to placing another person in the vehicle and again after the person is removed. This is to ensure that unauthorized or personal items have not been left in the vehicle.

Culver City Police Department

Culver City PD Policy Manual

Vehicle Use

All department vehicles are subject to inspection and/or search at any time by a supervisor without notice and without cause. No member assigned to or operating such vehicle shall be entitled to any expectation of privacy with respect to the vehicle or its contents.

703.3.4 SECURITY AND UNATTENDED VEHICLES

Unattended vehicles should be locked and secured at all times. No key should be left in the vehicle except when it is necessary that the vehicle be left running (e.g., continued activation of emergency lights, canine safety, equipment charging). Officers who exit a vehicle rapidly in an emergency situation or to engage in a foot pursuit must carefully balance the need to exit the vehicle quickly with the need to secure the vehicle.

Members shall ensure all weapons are secured while the vehicle is unattended.

703.3.5 VEHICLE LOCATION SYSTEM

Patrol and other vehicles, at the discretion of the Chief of Police, may be equipped with a system designed to track the vehicle's location. While the system may provide vehicle location and other information, members are not relieved of their responsibility to use required communication practices to report their location and status.

Members shall not make any unauthorized modifications to the system. At the start of each shift, members shall verify that the system is on and report any malfunctions to their supervisor. If the member finds that the system is not functioning properly at any time during the shift, he/she should exchange the vehicle for one with a working system, if available.

System data may be accessed by supervisors at any time. However, access to historical data by other than supervisors will require Bureau Commander approval.

All data captured by the system shall be retained in accordance with the established records retention schedule.

703.3.6 KEYS

Members approved to operate marked patrol vehicles should be issued a copy of the key as part of their initial equipment distribution. Members who are assigned a specific vehicle should be issued keys for that vehicle.

Members shall not duplicate keys. The loss of a key shall be promptly reported in writing through the member's chain of command.

703.3.7 AUTHORIZED PASSENGERS

Members operating department vehicles shall not permit persons other than City personnel or persons required to be conveyed in the performance of duty, or as otherwise authorized, to ride as passengers in the vehicle, except as stated in the Ride-Along Policy.

Culver City Police Department

Culver City PD Policy Manual

Vehicle Use

703.3.8 ALCOHOL OR DRUGS

Members who have consumed alcohol or marijuana are prohibited from operating any department vehicle unless it is required by the duty assignment (e.g., task force, undercover work). Regardless of assignment, members may not violate state law regarding vehicle operation while intoxicated.

703.3.9 PARKING

Except when responding to an emergency or when urgent department-related business requires otherwise, members driving department vehicles should obey all parking regulations at all times.

Department vehicles should be parked in assigned stalls. Members shall not park privately owned vehicles in stalls assigned to department vehicles or in other areas of the parking lot that are not so designated unless authorized by a supervisor. Privately owned motorcycles shall be parked in designated areas.

703.3.10 ACCESSORIES AND/OR MODIFICATIONS

There shall be no modifications, additions or removal of any equipment or accessories without written permission from the assigned vehicle program manager.

703.3.11 PROFESSIONAL STAFF MEMBER USE

Professional Staff members using marked emergency vehicles shall ensure that all weapons have been removed before going into service. Professional Staff members shall prominently display the "out of service" placards or light bar covers at all times. Professional Staff members shall not operate the emergency lights or siren of any vehicle unless expressly authorized by a supervisor.

703.4 INDIVIDUAL MEMBER ASSIGNMENT TO VEHICLES

Department vehicles may be assigned to individual members at the discretion of the Chief of Police. Vehicles may be assigned for on-duty and/or take-home use. Assigned vehicles may be changed at any time. Permission to take home a vehicle may be withdrawn at any time.

The assignment of vehicles may be suspended when the member is unable to perform the member's regular assignment.

703.4.1 ON-DUTY USE

Vehicle assignments shall be based on the nature of the member's duties, job description and essential functions, and employment or appointment status. Vehicles may be reassigned or utilized by other department members at the discretion of the Chief of Police or the authorized designee.

703.4.2 UNSCHEDULED TAKE-HOME USE

Circumstances may arise where department vehicles must be used by members to commute to and from a work assignment. Members may take home department vehicles only with prior approval of a supervisor and shall meet the following criteria:

- (a) The circumstances are unplanned and were created by the needs of the department.
- (b) Other reasonable transportation options are not available.

Culver City Police Department

Culver City PD Policy Manual

Vehicle Use

- (c) The member lives within a reasonable distance (generally not to exceed a 60-minute drive time) of the Culver City City limits.
- (d) Off-street parking will be available at the member's residence.
- (e) Vehicles will be locked when not attended.
- (f) All firearms, weapons and control devices will be removed from the interior of the vehicle and properly secured in the residence when the vehicle is not attended, unless the vehicle is parked in a locked garage.

703.4.3 ASSIGNED VEHICLES

Assignment of take-home vehicles shall be based on the location of the member's residence, the nature of the member's duties, job description and essential functions, and employment or appointment status. Residence in the City of Culver City is a prime consideration for assignment of a take-home vehicle. Members who reside outside the City of Culver City may be required to secure the vehicle at a designated location or the Department at the discretion of the Chief of Police.

Members are cautioned that under federal and local tax rules, personal use of a City vehicle may create an income tax liability for the member. Questions regarding tax rules should be directed to the member's tax adviser.

Criteria for use of take-home vehicles include the following:

- (a) Vehicles shall only be used for work-related purposes and shall not be used for personal errands or transports, unless special circumstances exist and with the approval of an immediate supervisor.
- (b) Vehicles may be used to transport the member to and from the member's residence for work-related purposes.
- (c) Vehicles will not be used when off-duty except:
 - (a) In circumstances when a member has been placed on call by the Chief of Police or Bureau Commanders and there is a high probability that the member will be called back to duty.
 - (b) When the member is performing a work-related function during what normally would be an off-duty period, including vehicle maintenance or travelling to or from a work-related activity or function.
 - (c) When the member has received permission from the Chief of Police or Bureau Commanders.
 - (d) When the vehicle is being used by the Chief of Police, Assistant Chief of Police, Bureau Commanders or members who are in on-call administrative positions.
 - (e) When the vehicle is being used by on-call investigators.
- (d) While operating the vehicle, authorized members will carry and have accessible their duty firearms and be prepared to perform any function they would be expected to perform while on-duty.

Culver City Police Department

Culver City PD Policy Manual

Vehicle Use

- (e) The two-way communications radio, MDC and global positioning satellite device, if equipped, must be on and set to an audible volume when the vehicle is in operation.
- (f) Unattended vehicles are to be locked and secured at all times.
 - (a) No key should be left in the vehicle except when it is necessary that the vehicle be left running (e.g., continued activation of emergency lights, canine safety, equipment charging).
 - (b) All weapons shall be secured while the vehicle is unattended.
 - (c) All department identification, portable radios and equipment should be secured.
- (g) Vehicles are to be parked off-street at the member's residence unless prior arrangements have been made with the Chief of Police or the authorized designee. If the vehicle is not secured inside a locked garage, all firearms and kinetic impact weapons shall be removed and properly secured in the residence (see the Firearms Policy regarding safe storage of firearms at home).
- (h) Vehicles are to be secured at the member's residence or the appropriate department facility, at the discretion of the Department when a member will be away (e.g., on vacation) for periods exceeding one week.
 - 1. If the vehicle remains at the residence of the member, the Department shall have access to the vehicle.
 - 2. If the member is unable to provide access to the vehicle, it shall be parked at the Department.
- (i) The member is responsible for the care and maintenance of the vehicle.

703.4.4 ENFORCEMENT ACTIONS

When driving a take-home vehicle to and from work outside of the jurisdiction of the Culver City Police Department or while off-duty, an officer shall not initiate enforcement actions except in those circumstances where a potential threat to life or serious property damage exists (see the Off-Duty Law Enforcement Actions and Law Enforcement Authority policies).

Officers may render public assistance when it is deemed prudent (e.g., to a stranded motorist).

Officers driving take-home vehicles shall be armed, appropriately attired and carry their department-issued identification. Officers should also ensure that department radio communication capabilities are maintained to the extent feasible.

703.4.5 MAINTENANCE

Members are responsible for the cleanliness (exterior and interior) and overall maintenance of their assigned vehicles. Cleaning and maintenance supplies will be provided by the Department. Failure to adhere to these requirements may result in discipline and loss of vehicle assignment. The following should be performed as outlined below:

- (a) Members shall make daily inspections of their assigned vehicles for service/maintenance requirements and damage.

Culver City Police Department

Culver City PD Policy Manual

Vehicle Use

- (b) It is the member's responsibility to ensure that the assigned vehicle is maintained according to the established service and maintenance schedule.
- (c) All scheduled vehicle maintenance and car washes shall be performed as necessary at a facility approved by the department supervisor in charge of vehicle maintenance.
- (d) The Department shall be notified of problems with the vehicle and approve any major repairs before they are performed.
- (e) When leaving the vehicle at the maintenance facility, the member will complete a vehicle repair card explaining the service or repair, and leave it on the seat or dash.
- (f) All weapons shall be removed from any vehicle left for maintenance.
- (g) Supervisors shall make, at a minimum, monthly inspections of vehicles assigned to members under their command to ensure the vehicles are being maintained in accordance with this policy.

703.5 DAMAGE, ABUSE AND MISUSE

When any department vehicle is involved in a traffic collision or otherwise incurs damage, the involved member shall promptly notify a supervisor. Any traffic collision report shall be filed with the agency having jurisdiction (see the Traffic Collision Reporting Policy).

Damage to any department vehicle that was not caused by a traffic collision shall be immediately reported during the shift in which the damage was discovered, documented in memorandum format and forwarded to the Watch Commander. An administrative investigation should be initiated to determine if there has been any vehicle abuse or misuse.

703.6 TOLL ROAD USAGE

Law enforcement vehicles are not routinely exempted from incurring toll road charges.

To avoid unnecessary toll road charges, all members operating department vehicles on a toll road shall adhere to the following:

- (a) Members operating department vehicles for any reason other than in response to an emergency shall pay the appropriate toll charge or utilize the appropriate toll way transponder. Members may submit a request for reimbursement from the City for any toll fees incurred in the course of official business.
- (b) Members passing through a toll plaza or booth during a response to an emergency shall notify, in writing, the appropriate Bureau Commander within five working days explaining the circumstances.

703.7 ATTIRE AND APPEARANCE

When operating any department vehicle while off-duty, members may dress in a manner appropriate for their intended activity. Whenever in view of or in contact with the public, attire and appearance, regardless of the activity, should be suitable to reflect positively upon the Department.

Military Equipment Funding, Acquisition and Use Policy

704.1 PURPOSE AND SCOPE

The purpose of this policy is to provide guidelines for the approval, acquisition, and reporting requirements of "military equipment" as defined in the California Government Code. (See Government Code §§ 7070- 7072). The Culver City Police Department does not possess any tactical equipment that it has obtained from the military, nor does it possess any equipment that is designed solely for military use.

704.2 PHILOSOPHY

The acquisition of military equipment and its deployment in our communities may impact the public's safety and welfare. The public has a right to know about any funding, acquisition, or use of military equipment by local government officials, as well as a right to participate in any government agency's decision to fund, acquire, or use such equipment. Decisions on whether and how to fund, acquire, or use military equipment will be made with strong consideration for the public's welfare, safety, civil rights, and civil liberties and also account for the public's input.

Members of the Culver City Police Department will only use military equipment in compliance with federal and state legal authorities, including the Fourth and Fifth Amendments of the U.S. Constitution; Article 1, Section 1 of the California Constitution; Government Codes § 7286 and 12525.2; and California Penal Codes §§ 835a and 13652 as well as the Culver City Police Department's Duty Manual and General Orders. Members of the Culver City Police Department will only use military equipment consistent with applicable Department rules and regulations, including the Use of Force Policy (Section 300) contained in the Culver City Police Department Duty Manual.

704.3 APPROVAL OF THE GOVERNING BODY

The Chief of Police or his/her authorized designee shall seek approval for this policy from the governing body in the form of an ordinance adopting the policy. As part of the approval-seeking process, the Chief of Police, or his/her authorized designee, will submit the proposed military equipment policy to the governing body and make it available on the Department website at least 30 days prior to any public hearing concerning the military equipment at issue (Government Code § 7071).

The governing body must approve the policy prior to the Department or its members engaging in any of the following (Government Code § 7071):

- (a) Requesting military equipment made available by the U.S. Department of Defense pursuant to 10 USC § 2576a.
- (b) Seeking funds for military equipment, including but not limited to applying for a grant, soliciting, or accepting private, local, state, or federal funds, in-kind donations, or other donations or transfers.

Culver City Police Department

Culver City PD Policy Manual

Military Equipment Funding, Acquisition and Use Policy

- (c) Acquiring military equipment either permanently or temporarily, including by borrowing or leasing.
- (d) Collaborating with another law enforcement agency in the deployment or other use of military equipment within the jurisdiction of this department.
- (e) Using any new or existing military equipment for a purpose, in a manner, or by a person not previously approved by the governing body.
- (f) Soliciting or responding to a proposal for, or entering into an agreement with, any other person or entity to seek funds for, apply to receive, acquire, use, or collaborate in the use of military equipment.
- (g) Acquiring military equipment through any means not provided above.

704.4 DEFINITIONS

Definitions related to this policy include (Government Code § 7070):

Governing body – The City Council of Culver City.

Military equipment categories– Includes the following:

- Unmanned, remotely piloted, powered aerial or ground vehicles.
- Mine-resistant ambush-protected (MRAP) vehicles or armored personnel carriers.
- High mobility multipurpose wheeled vehicles (HMMWV), two-and-one-half-ton trucks, five-ton trucks, or wheeled vehicles that have a breaching or entry apparatus attached.
- Tracked armored vehicles that provide ballistic protection to their occupants
- Command and control vehicles that are either built or modified to facilitate the operational control and direction of public safety units.
- Weaponized aircraft, vessels, or vehicles of any kind.
- Battering rams, slugs, and breaching apparatuses that are explosive in nature. This does not include a handheld, one-person ram.
- Firearms and ammunition of .50 caliber or greater, excluding standard-issue shotguns and standard-issue shotgun ammunition.
- Specialized firearms and ammunition of less than .50 caliber, including firearms and accessories identified as assault weapons in Penal Code § 30510 and Penal Code § 30515, with the exception of standard-issue handguns.
- Any firearm or firearm accessory that is designed to launch explosive projectiles.
- Noise-flash diversionary devices and explosive breaching tools.
- Munitions containing tear gas or OC, excluding standard, service-issued handheld pepper spray.
- TASER® Shockwave, microwave weapons, water cannons, and long-range acoustic devices (LRADs).
- Kinetic energy weapons and munitions.

Culver City Police Department

Culver City PD Policy Manual

Military Equipment Funding, Acquisition and Use Policy

- Any other equipment as determined by a governing body or a state agency to require additional oversight.

704.5 POLICY

It is the policy of the Culver City Police Department that there are legally enforceable safeguards, including transparency, oversight, and accountability measures in place to protect the public's welfare, safety, civil rights, and civil liberties before military equipment is funded, acquired, or used.

The Department, through the designated Military Equipment Coordinator, will train members of the Department to use military equipment only in accordance with this Policy, the Culver City Police Department Duty Manual, as well as federal, state, and local laws and ordinances. Members using military equipment for uses not identified as approved uses in the Military Equipment Inventory are subject to discipline, up to and including termination. All instances of non-compliance will be reported to City Council via the annual military equipment report.

The City Council has independent oversight of the Department's compliance with this Policy.

704.6 MILITARY EQUIPMENT COORDINATOR

The Chief of Police will designate a member of this Department to act as the Military Equipment Coordinator ("Coordinator"). The responsibilities of the Coordinator include:

- (a) Acting as a liaison to the governing body for matters related to the requirements of this policy.
- (b) Identifying Department equipment that qualifies as "military equipment" as defined in Government Code § 7070, in the current possession of the Department, or the equipment the Department intends to acquire, that requires approval by the governing body.
- (c) Conducting an inventory of all military equipment at least annually.
- (d) Collaborating with any allied agency that may use military equipment within the jurisdiction of Culver City Police Department (Government Code § 7071).
- (e) Preparing for, scheduling, and coordinating the annual community engagement meeting to include:
 1. Publicizing the details of the meeting.
 2. Preparing for public questions regarding the department's funding, acquisition, and use of equipment.
- (f) Preparing the annual military equipment report for submission to the Chief of Police Use of force and ensuring that the report is made available on the department website (Government Code § 7072).
- (g) Receive and timely response to public concerns, complaints, or questions regarding the use of military equipment.

704.7 PUBLIC COMPLAINTS, CONCERNS, AND QUESTIONS

Concerns, complaints, and questions regarding the use of military equipment may be submitted in writing to:

Culver City Police Department

Culver City PD Policy Manual

Military Equipment Funding, Acquisition and Use Policy

Attn: Military Equipment Coordinator

4040 Duquesne Ave, Culver City, CA 90232

Email: Chief.police@culvercity.org

Telephonic complaints regarding the use of military equipment may be made by calling the Culver City Police Department Professional Standards Unit at (310) 253-6211.

Whenever practical, the Coordinator will respond to concerns, complaints, and questions within 30 calendar days of receipt. As outlined in Culver City Duty Manual Section 1008, all complaints will be thoroughly investigated in accordance with federal, state, local laws, and ordinances.

The Coordinator will track complaints, concerns, questions received, and the responses provided, in order to be able to include the information in the Annual Report described below.

704.8 MILITARY EQUIPMENT INVENTORY

The following constitutes a list of qualifying equipment in the possession of the Department:

[AB 481 Equipment Inventory](#)

704.9 COORDINATION WITH OTHER JURISDICTIONS

Culver City Police Department will not collaborate with other law enforcement agencies to use military equipment in this jurisdiction unless the military equipment is approved for use and used in accordance with this policy. The following constitutes a list of qualifying equipment in the Department's possession that may be used in collaboration with another Department:

See attachment: MILITARY EQUIPMENT NOT OWNED BY DEPARTMENT SUBJECT TO COLLABORATIVE USE.pdf

704.10 ANNUAL REPORT

Upon approval of the military equipment policy, the Chief of Police or their authorized designee will submit a military equipment report to the governing body for each type of military equipment approved within one year of approval and annually thereafter, for as long as the military equipment is available for use (Government Code § 7072).

The annual military use equipment report will include, for each type of military equipment:

- (a) A summary of how the military equipment was used and the purpose of its use.
- (b) A summary of any complaints or concerns received concerning the military equipment.
- (c) The results of any internal audits, any information about violations of the military equipment use policy, and any actions taken in response.
- (d) The total annual costs for each type of military equipment, including acquisition, personnel, training, transportation, maintenance, storage, upgrade, and other ongoing costs, and from what source funds will be provided for the military equipment in the calendar year following submission of the annual military equipment report.
- (e) The quantity possessed for each type of military equipment.

Culver City Police Department

Culver City PD Policy Manual

Military Equipment Funding, Acquisition and Use Policy

- (f) If the law enforcement agency intends to acquire additional military equipment in the next year, the quantity sought for each type of military equipment.

The Chief of Police or the authorized designee will make each annual military equipment report publicly available on the department website for as long as the military equipment is available for use. The report shall include all information required by Government Code § 7072 for the preceding calendar year for each type of military equipment in department inventory.

704.11 COMMUNITY ENGAGEMENT

Within 30 days of submitting and publicly releasing the annual report, the Department will hold at least one well-publicized and conveniently located community engagement meeting, at which the Department will discuss the report and respond to public questions regarding the funding, acquisition, or use of military equipment.

NOISE FLASH DIVERSIONARY DEVICE (Flashbangs)

705.1 PURPOSE AND SCOPE

This policy provides guidelines for the use and maintenance of Noise Flash Diversionary Devices (NFDDs) that are described in this policy.

705.2 POLICY

During specified Emergency Response Team operations and during high-risk field operations involving violent suspect(s), the Culver City Police Department authorizes officers to use NFDDs in accordance with the guidelines in this policy.

705.3 USER RESPONSIBILITIES

All normal maintenance shall remain the responsibility of the Range Master (and/or ERT armorer). Any damaged, inoperative, or outdated, NFDDs, along with documentation explaining the cause of the damage, shall be returned to the Rangemaster for disposition. Damage to City property forms shall also be prepared and forwarded through the chain of command, when appropriate, explaining the cause of damage.

705.4 RANGEMASTER RESPONSIBILITIES

The Rangemaster (and/or ERT Armorer) shall control the inventory and issuance of all NFDDs and shall ensure that all damaged, inoperative, or outdated, NFDDs are properly disposed of, repaired, or replaced.

All NFDDs will be periodically inspected by the Rangemaster or the designated instructor. The inspection shall be documented and forwarded up the Chain of Command.

705.5 NOISE FLASH DIVERSIONARY DEVICE (NFDD)

A Noise Flash Diversionary Device (NFDD) is a device that creates a bright flash and loud sound to temporarily divert the attention of subjects in the immediate area. NFDDs are used to distract and temporarily disorient dangerous suspects by overwhelming their senses of vision and hearing. The distraction allows officers to seize a moment of opportunity to take control of high-risk situations.

705.6 GUIDELINES FOR USE

Diversionary Devices shall only be used:

- (a) During encounters with self-destructive, violent, dangerous and/or combative subjects.
- (b) Circumstances where the Emergency Response Team members can obtain a tactical advantage during the following critical incidents: Barricaded violent felony suspect, vehicle barricade of a felony suspect, active shooter, or a hostage rescue operation.
- (c) During high-risk warrant (search/arrest) service.
- (d) During department-approved training exercises.

Culver City Police Department

Culver City PD Policy Manual

NOISE FLASH DIVERSIONARY DEVICE (Flashbangs)

705.7 AUTHORIZED USE

- (a) By ERT officers who have been trained in their proper use in accordance with POST guidelines and have received annual training by a POST-certified instructor.
- (b) NFDDs shall not be used for crowd dispersal.
- (c) All uses of NFDDs must first be approved by a Bureau Captain.
- (d) In compliance with federal, state, and local laws and ordinances.

705.8 REPORTING GUIDELINES

Whenever NFDDs are carried by personnel in an actual situation or incident, that fact shall be noted in an appropriate report. In the event devices are deployed, the circumstances surrounding their deployment shall be fully documented in appropriate reports. The ERT Commander shall be responsible for reviewing any deployment of NFDDs to ensure that policy and procedure were adhered to. The ERT Commander shall document their review and submit the review to the ERU Commander. Additionally, deployment of an NFDD system shall also be documented in the Annual Military Equipment report as outlined in policy #704.

705.9 TRAINING FOR NFDD

The Emergency Response Team Commander shall ensure that all personnel who are authorized to carry NFDDs have been properly trained and certified.

Proficiency training shall be monitored and documented by a certified NFDD instructor.

- (a) All training and proficiency for NFDDs will be documented in the officer's training file.

705.10 ATF GUIDELINES

Noise flash diversionary devices are registered by serial number with the Bureau of Alcohol Tobacco and Firearms (ATF). Typically, the Department's purchase of new devices is reported directly (by case-lot serial numbers) to ATF by the device manufacturer via ATF Form 5. The National Firearms Act requires the Department to notify ATF upon the use/expenditure of NFDDs. An Emergency Response Team Leader shall be responsible for submitting written notification to ATF when all devices listed on a single ATF Form 5 have been used/expended.

Bureau of Alcohol, Tobacco, and Firearms

National Firearms Branch

244 Neely Road Martinsburg, WV 25405

(304) 616-4500

Armored Vehicle

706.1 PURPOSE AND SCOPE

The purpose of this policy is to provide direction for the use, training, and storage of the Armored Vehicle (AV).

706.2 USE OF THE ARMORED VEHICLE

The use of the AV is to assist with the preservation of life and enhance the safety of citizens and officers. The AV shall be deployed in situations where its use would enhance the advantage of police personnel, aid in the rescue of injured persons, and improve the likelihood that an incident can be resolved without the use of deadly force.

Use of the AV shall be authorized by the Emergency Response Unit (ERU) Captain. If the ERU Captain cannot be reached, the Watch Commander can approve the use of the AV in emergency situations. The ERU Captain shall be notified following any emergency AV deployments and advised of the circumstances surrounding the incident.

The Emergency Response Team Commander, along with the Military Equipment Coordinator, shall be notified following all AV deployments.

706.3 AUTHORIZED DEPLOYMENTS

The AV shall only be deployed for critical incidents involving actual, threatened, or suspected violence related to loss of life or serious bodily injury. Such incidents include, but are not limited to:

- Active shooter/mass casualty Incidents
- Rescue operations
- Supporting search and arrest warrant operations
- Barricaded suspect operations
- Hostage operations
- During encounters with self-destructive, violent, dangerous, and/or combative subjects.
- During department-approved training exercises.
- Perimeter Searches for Armed and/or Felony Suspects

The AV, with approval granted by the Chief of Police or his/her designee, can be used for community events, public relations display, and mutual aid assistance.

706.4 PROHIBITED USE OF ARMORED VEHICLE

The AV shall not be used for routine patrol functions or details. The AV at no time, will be used for intimidation purposes during peaceful protests or demonstrations.

Culver City Police Department

Culver City PD Policy Manual

Armored Vehicle

706.5 USE OF THE ARMORED VEHICLE BY OUTSIDE AGENCIES

The use of the Department's AV by outside agencies shall be authorized by the ERU Commander, or his/her designee.

706.6 ARMORED VEHICLE OPERATOR TRAINING

Armored vans will be deployed by officers who have received department training in the vans' operation.

706.7 ARMORED VEHICLE STORAGE

The Department's AV will be stored at the Culver City Police Department. It may be stored in the City Maintenance yard when repairs are necessary.

706.8 ARMORED VEHICLE MAINTENANCE

Maintenance of the AV is the responsibility of the ERT Commander or his/her designee. Officers from the Emergency Response Team will routinely check the AV, ensuring its equipment is properly stored and in good working order.

706.9 ARMORED VEHICLE DEPLOYMENT RECORDS

All deployment and training records associated with the Armored Vehicle will be the responsibility of the Military Equipment Coordinator. The Military Equipment Coordinator will track each deployment incident, to include any/all non-ERT related deployments and additional maintenance/repair costs associated with the AV.

Chapter 8 - Support Services

Crime Analysis

800.1 PURPOSE AND SCOPE

Crime analysis should provide currently useful information to aid operational personnel in meeting their tactical crime control and prevention objectives by identifying and analyzing methods of operation of individual criminals, providing crime pattern recognition, and providing analysis of data from field interrogations and arrests. Crime analysis can be useful to the Department's long range planning efforts by providing estimates of future crime trends and assisting in the identification of enforcement priorities.

800.2 DATA SOURCES

Crime analysis data is extracted from many sources including, but not limited to:

- Crime reports
- Field Interview cards
- Parole and Probation records
- Computer Aided Dispatch data
- Shared regional crime data
- Statewide Integrated Traffic Reporting System (SWITRS)

800.3 CRIME ANALYSIS FACTORS

The following minimum criteria should be used in collecting data for Crime Analysis:

- Frequency by type of crime
- Geographic factors
- Temporal factors
- Victim and target descriptors
- Suspect descriptors
- Suspect vehicle descriptors
- Modus operandi factors
- Physical evidence information

800.4 CRIME ANALYSIS DISSEMINATION

For a crime analysis system to function effectively, information should be disseminated to the appropriate units or persons on a timely basis. Information that is relevant to the operational and tactical plans of specific line units should be sent directly to them. Information relevant to the development of the Department's strategic plans should be provided to the appropriate staff units. When information pertains to tactical and strategic plans, it should be provided to all affected units.

Telecommunications Evidence

801.1 PURPOSE AND SCOPE

The purpose of this policy is to establish the protocol for maintaining recorded telecommunications evidence.

Currently, the Department contracts its telecommunications services with the Southbay Regional Communications Center (Southbay RCC), located in the City of Hawthorne, and adheres to their existing policies regarding the preservation and production of telecommunications evidence.

801.1.1 REQUIREMENTS

- (a) Recording of radio frequencies and telephone lines shall be maintained as there is space available.
- (b) A copy of subpoenaed evidence will be made to a media useable in court.

801.2 TELECOMMUNICATIONS EVIDENCE

Circumstances that may require securing telecommunication evidence include, but are not limited to:

- (a) A crime in which, in the investigating officer's opinion, the telecommunications evidence is relevant to the guilt or innocence of a suspect.
- (b) If, in the Watch Commander's opinion, an incident occurs which will likely result in civil action in which the City may be a party.
- (c) All officer involved shooting incidents.
- (d) Pursuits involving injury or significant property damage.
- (e) A use of force wherein the person being taken into custody sustains major injuries, or if significant property damage occurs.
- (f) During acts of civil disobedience or unrest.
- (g) As a result of a complaint alleging misconduct or negligence on the part of a member of this department.
- (h) Any time a supervisor determines that the telecommunications evidence would be beneficial as a training tool and retrieval of the evidence is approved by the Communications Supervisor.
- (i) Any other time in which a supervisor determines that review of the telecommunications evidence is needed and retrieval of the evidence is approved by the Communications Supervisor.

801.3 SUBPOENAED TELECOMMUNICATIONS EVIDENCE

If a subpoena is received for a telecommunication recording prior to the recording being purged or recorded over, that data will be copied and retained in the appropriate manner.

Culver City Police Department

Culver City PD Policy Manual

Telecommunications Evidence

Department personnel should contact a Southbay RCC Supervisor to make the appropriate request, which should include the following information:

- (a) Event date
- (b) Defendant/ victim name
- (c) Requestor name/ title
- (d) Preparer
- (e) Time
- (f) Request date
- (g) Completion date
- (h) Investigator
- (i) Incident/ DR Number

801.4 AUTHORIZED TELECOMMUNICATIONS REQUESTS, USE AND REVIEW OF TELECOMMUNICATIONS EVIDENCE

Telecommunications requests in the course of departmental or criminal investigations may be made with a Southbay RCC Supervisor.

1. The requesting employee shall complete the appropriate request via the Southbay RCC website.
2. The Southbay RCC supervisor or designee will handle the request and return the information to the requestor via email.

Property and Evidence Section

802.1 PURPOSE AND SCOPE

This policy provides for the proper collection, storage, and security of evidence and other property. Additionally, this policy provides for the protection of the chain of evidence and identifies those persons authorized to remove and/or destroy property.

802.1.1 DEFINITIONS

Definitions related to this policy include:

Property - All articles placed in secure storage within the Property and Evidence Section, including the following:

- Evidence - Items taken or recovered in the course of an investigation that may be used in the prosecution of a case, including photographs and latent fingerprints.
- Found property - Items found by members of the Department or the public that have no apparent evidentiary value and where the owner cannot be readily identified or contacted.
- Safekeeping - Items received by the Department for safekeeping, such as a firearm, the personal property of an arrestee that has been not taken as evidence, and items taken for safekeeping under authority of law.

802.2 PROPERTY HANDLING

Any employee who first comes into possession of any property shall retain such property in his/her possession until it is properly tagged and placed in the designated property locker or storage room along with the property form. Care shall be taken to maintain the chain of custody for all evidence.

Where ownership can be established as to found property with no apparent evidentiary value, such property may be released to the owner without the need for booking. The property release form should be completed to document the release of property not booked and the owner shall sign the form acknowledging receipt of the items.

802.2.1 PROPERTY BOOKING PROCEDURE

All property must be booked prior to the employee going off-duty unless otherwise approved by a supervisor. Employees booking property shall observe the following guidelines:

- (a) Ensure mention of booked property in the report narrative including description, owner's name, and finder's name.
- (b) Complete the property report describing each item of property separately, listing all serial numbers, owner's name, and other identifying information or markings.
 1. Note: all items with serial numbers must receive an FCN number from a Records Technician.
- (c) Complete an evidence/property label and attach it to each package or envelope in which the property is stored, and complete all preprinted information requested on

Culver City Police Department

Culver City PD Policy Manual

Property and Evidence Section

the evidence/property envelope itself. Information should include, at a minimum, Case number, booking officer's name and serial number, property description, owner name (if known), date/time of seizure, and whether item(s) are to be held as Evidence, Safekeeping, or Found.

- (d) The property report shall be submitted with the case report.
- (e) When the property is too large to be placed in a locker, the item may be retained in an otherwise secure room. Submit the completed property record into a numbered locker indicating the location of the property.

802.2.2 NARCOTICS AND DANGEROUS DRUGS

All narcotics and dangerous drugs shall be booked separately using a separate property envelope. Narcotics envelopes shall be completely filled out including drug type, weight, date, time, who found it, where it was found and suspect's full name. Paraphernalia as defined by Health and Safety Code § 11364 shall also be booked separately, and housed in an appropriate biohazard container.

802.2.3 EXPLOSIVES

Officers who encounter a suspected explosive device shall promptly notify their immediate supervisor or the Watch Commander. The bomb squad will be called to handle explosive-related incidents and will be responsible for the handling, storage, sampling and disposal of all suspected explosives.

Explosives will not be retained in the police facility. Only fireworks that are considered stable and safe and road flares or similar signaling devices may be booked into property. All such items shall be stored in proper containers and in an area designated for the storage of flammable materials. The Property Technician is responsible for transporting to the Fire Department, on a regular basis, any fireworks or signaling devices that are not retained as evidence.

802.2.4 EXCEPTIONAL HANDLING

Certain property items require a separate booking/handling process. The following items should be processed in the described manner:

- (a) Bodily fluids such as blood or semen stains shall be air-dried prior to booking.
- (b) License plates found not to be stolen or connected with a known crime, should be released directly to the Property Technician, or placed in the designated container for return to the Department of Motor Vehicles. No formal property booking process is required.
- (c) All bicycles and bicycle frames require a property record. Property tags will be securely attached to each bicycle or bicycle frame. The property may be released directly to the Property Technician, or placed in the bicycle storage area until a Property Technician can log the property.
- (d) All cash in excess of \$100 shall be counted in the presence of a supervisor and the envelope initialed by the booking officer and the supervisor.

Culver City Police Department

Culver City PD Policy Manual

Property and Evidence Section

802.2.5 RELINQUISHED FIREARMS

Individuals who relinquish firearms pursuant to the provisions of Penal Code § 29850 shall be issued a receipt that describes the firearm, the serial number or other identification of the firearm at the time of relinquishment (Penal Code § 29810).

Relinquished firearms shall be retained for 30 days, after which time they may be destroyed, retained, sold or otherwise transferred, unless (Penal Code § 29810):

- (a) A certificate is issued by a judge of a court of record or the District Attorney stating the firearms shall be retained; or
- (b) The convicted person provides written notice of an intent to appeal the conviction that necessitated the relinquishment; or
- (c) The Automated Firearms System indicates that the firearm was reported lost or stolen.
 1. In such event, the firearm shall be restored to the lawful owner as soon as it is no longer needed as evidence, the lawful owner has identified the weapon and provided proof of ownership, and the Department has complied with the requirements of Penal Code § 33850 et seq.

The Property Technician shall ensure the Records Supervisor is notified of the relinquished firearm for purposes of updating the Automated Firearms System and the disposition of the firearm for purposes of notifying the California Department of Justice (DOJ) (See the Records Section Policy).

802.3 PACKAGING OF PROPERTY

Certain items require special consideration and shall be booked separately as follows:

- (a) Narcotics and dangerous drugs (Must be K-packed)
- (b) Firearms (ensure they are unloaded and booked separately from ammunition)
- (c) Property with more than one known owner
- (d) Paraphernalia as described in Health and Safety Code § 11364
- (e) Fireworks
- (f) Contraband

802.3.1 PACKAGING CONTAINER

Employees shall package all property, except narcotics and dangerous drugs in a suitable container available for its size. Knife boxes should be used to package knives, and syringe tubes should be used to package syringes and needles.

A property tag shall be securely attached to the outside of all items or group of items packaged together.

802.3.2 PACKAGING NARCOTICS

The officer seizing narcotics and dangerous drugs shall retain such property in his/her possession until it is properly weighed, packaged, tagged, and placed in the designated narcotics locker, accompanied by two copies of the property record. Prior to packaging and if the quantity allows, a

Culver City Police Department

Culver City PD Policy Manual

Property and Evidence Section

presumptive test should be made on all suspected narcotics. If conducted, the results of this test shall be included in the officer's report.

Narcotics and dangerous drugs shall be packaged in an envelope of appropriate size available in the report room. The booking officer shall initial the sealed envelope and the initials covered with cellophane tape. Narcotics and dangerous drugs shall not be packaged with other property.

A completed property tag shall be attached to the outside of the container. The chain of evidence shall be recorded on the back of this tag.

802.4 RECORDING OF PROPERTY

The Property Technician receiving custody of evidence or property shall record his/her signature, the date and time the property was received and where the property will be stored on the property control card.

A property number shall be obtained for each item or group of items. This number shall be recorded on the property tag and the property control card.

Any changes in the location of property held by the Culver City Police Department shall be noted in the property logbook.

802.5 PROPERTY CONTROL

Each time the Property Technician receives property or releases property to another person, he/she shall enter this information on the property control card. Officers desiring property for court shall contact the Property Technician at least one day prior to the court day.

802.5.1 RESPONSIBILITY OF OTHER PERSONNEL

Every time property is released or received, an appropriate entry on the evidence package shall be completed to maintain the chain of evidence. No property or evidence is to be released without first receiving written authorization from a supervisor or detective.

Request for analysis for items other than narcotics or drugs shall be completed on the appropriate forms and submitted to the Property Technician. This request may be filled out any time after booking of the property or evidence.

802.5.2 TRANSFER OF EVIDENCE TO CRIME LABORATORY

The transporting employee will check the evidence out of property, indicating the date and time on the property control card and the request for laboratory analysis.

The Property Technician releasing the evidence must complete the required information on the property control card and the evidence. The lab forms will be transported with the property to the examining laboratory. Upon delivering the item involved, the officer will record the delivery time on both copies, and indicate the locker in which the item was placed or the employee to whom it was delivered. The original copy of the lab form will remain with the evidence and the copy will be returned to the Records Section for filing with the case.

Culver City Police Department

Culver City PD Policy Manual

Property and Evidence Section

802.5.3 STATUS OF PROPERTY

Each person receiving property will make the appropriate entry to document the chain of evidence. Temporary release of property to officers for investigative purposes, or for court, shall be noted on the property control card, stating the date, time and to whom released.

The Property Technician shall obtain the signature of the person to whom property is released, and the reason for release. Any employee receiving property shall be responsible for such property until it is properly returned to property or properly released to another authorized person or entity.

The return of the property should be recorded on the property control card, indicating date, time, and the person who returned the property.

802.5.4 AUTHORITY TO RELEASE PROPERTY

The Detective Bureau shall authorize the disposition or release of all evidence and property coming into the care and custody of the Department.

802.5.5 RELEASE OF PROPERTY

All reasonable attempts shall be made to identify the rightful owner of found property or evidence not needed for an investigation.

Release of property shall be made upon receipt of an authorized release form, listing the name and address of the person to whom the property is to be released. The release authorization shall be signed by the authorizing supervisor or detective and must conform to the items listed on the property form or must specify the specific item(s) to be released. Release of all property shall be documented on the property form.

With the exception of firearms and other property specifically regulated by statute, found property and property held for safekeeping shall be held for a minimum of 90 days. During such period, property personnel shall attempt to contact the rightful owner by telephone and/or mail when sufficient identifying information is available. Property not held for any other purpose and not claimed within 90 days after notification (or receipt, if notification is not feasible) may be auctioned to the highest bidder at a properly published public auction. If such property is not sold at auction or otherwise lawfully claimed, it may thereafter be destroyed (Civil Code § 2080.6). The final disposition of all such property shall be fully documented in related reports.

A Property Technician shall release the property upon proper identification being presented by the owner for which an authorized release has been received. A signature of the person receiving the property shall be recorded on the original property form. After release of all property entered on the property control card, the card shall be forwarded to the Records Section for filing with the case. If some items of property have not been released, the property card will remain with the Property and Evidence Section. Upon release, the proper entry shall be documented in the Property Log.

Under no circumstances shall any firearm, magazine, or ammunition be returned to any individual unless and until such person presents valid identification and written notification from the California Department of Justice that conforms to the provisions of Penal Code § 33865.

Culver City Police Department

Culver City PD Policy Manual

Property and Evidence Section

The Property and Evidence Section Supervisor should also make reasonable efforts to determine whether the person is the subject of any court order preventing the person from possessing a firearm and, if so, the firearm should not be released to the person while the order is in effect.

The Department is not required to retain any firearm, magazine, or ammunition longer than 180 days after notice has been provided to the owner that such items are available for return. At the expiration of such period, the firearm, magazine, or ammunition may be processed for disposal in accordance with applicable law (Penal Code § 33875).

802.5.6 DISPUTED CLAIMS TO PROPERTY

Occasionally more than one party may claim an interest in property being held by the Department, and the legal rights of the parties cannot be clearly established. Such property shall not be released until one party has obtained a valid court order or other undisputed right to the involved property.

All parties should be advised that their claims are civil and in extreme situations, legal counsel for the Department may wish to file an interpleader to resolve the disputed claim (Code of Civil Procedure § 386(b)).

802.5.7 RELEASE OF FIREARMS IN DOMESTIC VIOLENCE MATTERS

Within five days of the expiration of a restraining order issued in a domestic violence matter that required the relinquishment of a firearm or ammunition, the Property Technician shall return the weapon or ammunition to the owner if the requirements of Penal Code § 33850 and Penal Code § 33855 are met, unless the firearm or ammunition is determined to be stolen, evidence in a criminal investigation, another successive order has been issued against the individual, or the individual is otherwise prohibited from possessing a firearm (Family Code § 6389(g); Penal Code § 29825.5; Penal Code § 33855).

802.5.8 RELEASE OF FIREARMS AND WEAPONS IN MENTAL ILLNESS MATTERS

Firearms, other deadly weapons, or ammunition confiscated or relinquished from an individual detained for an evaluation by a mental health professional or subject to the provisions of Welfare and Institutions Code § 8100 or Welfare and Institutions Code § 8103 shall be released or disposed of as follows:

- (a) If a petition for a hearing regarding the return of a firearm or a weapon has been initiated pursuant to Welfare and Institutions Code § 8102(c), the firearm or weapon shall be released or disposed of as provided by an order of the court. If the court orders a firearm returned, the firearm shall not be returned unless and until the person presents valid identification and written notification from the California Department of Justice (DOJ) that conforms to the provisions of Penal Code § 33865.
- (b) If no petition has been initiated pursuant to Welfare and Institutions Code § 8102(c) and the firearm or weapon is not retained as evidence, the Department shall make the firearm or weapon available for return. No firearm will be returned unless and until the person presents valid identification and written notification from the California DOJ that conforms to the provisions of Penal Code § 33865.

Culver City Police Department

Culver City PD Policy Manual

Property and Evidence Section

- (c) Unless the person contacts the Department to facilitate the sale or transfer of the firearm to a licensed dealer pursuant to Penal Code § 33870, firearms not returned should be sold, transferred, destroyed, or retained as provided in Welfare and Institutions Code § 8102.

802.5.9 RELEASE OF FIREARMS IN GUN VIOLENCE RESTRAINING ORDER MATTERS

Firearms and ammunition that were taken into temporary custody or surrendered pursuant to a gun violence restraining order shall be returned to the restrained person upon the expiration of the order, verification that the person is not otherwise legally prohibited from possessing a firearm, and in accordance with the requirements of Penal Code § 33850 et seq. (Penal Code § 18108; Penal Code § 18120).

If the restrained person who owns the firearms or ammunition does not wish to have the firearm or ammunition returned, they are entitled to sell or transfer title to a licensed dealer, provided that the firearms or ammunition are legal to own or possess and the restrained person has right to title of the firearms or ammunition (Penal Code § 18120).

If a person other than the restrained person claims title to the firearms or ammunition surrendered pursuant to Penal Code § 18120 and the Culver City Police Department determines the person to be the lawful owner, the firearms or ammunition shall be returned in accordance with the requirements of Penal Code § 33850 et seq. (Penal Code § 18120).

Firearms and ammunition that are not claimed are subject to the requirements of Penal Code § 34000.

802.5.10 RELEASE OF FIREARMS, MAGAZINES, AND AMMUNITION

The Department shall not return any firearm, magazine, or ammunition taken into custody to any individual unless all requirements of Penal Code § 33855 are met.

802.6 DISPOSITION OF PROPERTY

All property not held for evidence in a pending criminal investigation or proceeding, and held for six months or longer where the owner has not been located or fails to claim the property, may be disposed of in compliance with existing laws upon receipt of proper authorization for disposal. The Property Technician shall request a disposition or status on all property which has been held in excess of 120 days, and for which no disposition has been received from a supervisor or detective.

802.6.1 EXCEPTIONAL DISPOSITIONS

The following types of property shall be destroyed or disposed of in the manner, and at the time prescribed by law, unless a different disposition is ordered by a court of competent jurisdiction:

- Weapons declared by law to be nuisances (Penal Code § 25700; Penal Code § 26110; Penal Code § 26395; Penal Code § 29300; Penal Code § 18010; Penal Code § 32750)
- Animals, birds, and related equipment that have been ordered forfeited by the court (Penal Code § 599a)
- Counterfeiting equipment (Penal Code § 480)

Culver City Police Department

Culver City PD Policy Manual

Property and Evidence Section

- Gaming devices (Penal Code § 335a)
- Obscene matter ordered to be destroyed by the court (Penal Code § 312)
- Altered vehicles or component parts (Vehicle Code § 10751)
- Narcotics (Health and Safety Code § 11474 et seq.)
- Unclaimed, stolen, or embezzled property (Penal Code § 1411)
- Destructive devices (Penal Code § 19000)
- Sexual assault evidence (Penal Code § 680)

802.6.2 UNCLAIMED MONEY

If found or seized money is no longer required as evidence and remains unclaimed after three years, the Department shall cause a notice to be published each week for a period of two consecutive weeks in a local newspaper of general circulation (Government Code § 50050). Such notice shall state the amount of money, the fund in which it is held and that the money will become the property of the agency on a designated date not less than 45 days and not more than 60 days after the first publication (Government Code § 50051).

Any individual item with a value of less than \$15.00, or any amount if the depositor/owner's name is unknown, which remains unclaimed for a year or by order of the court, may be transferred to the general fund without the necessity of public notice (Government Code § 50055).

If the money remains unclaimed as of the date designated in the published notice, the money will become the property of this department to fund official law enforcement operations. Money representing restitution collected on behalf of victims shall either be deposited into the Restitution Fund or used for purposes of victim services.

802.6.3 RETENTION OF BIOLOGICAL EVIDENCE

The Property and Evidence Section Supervisor shall ensure that no biological evidence held by the Department is destroyed without adequate notification to the following persons, when applicable:

- (a) The defendant
- (b) The defendant's attorney
- (c) The appropriate prosecutor and Attorney General
- (d) Any sexual assault victim
- (e) The Investigations Bureau Bureau supervisor

Biological evidence shall be retained for either a minimum period that has been established by law (Penal Code § 1417.9) or that has been established by the Property and Evidence Section Supervisor, or until the expiration of any imposed sentence that is related to the evidence, whichever time period is greater. Following the retention period, notifications should be made by certified mail and should inform the recipient that the evidence will be destroyed after a date specified in the notice unless a motion seeking an order to retain the sample is filed and served on

Culver City Police Department

Culver City PD Policy Manual

Property and Evidence Section

the Department within 180 days of the date of the notification. A record of all certified mail receipts shall be retained in the appropriate file. Any objection to, or motion regarding, the destruction of the biological evidence should be retained in the appropriate file and a copy forwarded to the Investigations Bureau Bureau supervisor.

Biological evidence related to a homicide shall be retained indefinitely and may only be destroyed with the written approval of the Chief of Police and the head of the applicable prosecutor's office.

Biological evidence or other crime scene evidence from an unsolved sexual assault should not be disposed of prior to expiration of the statute of limitations and shall be retained as required in Penal Code § 680. Even after expiration of an applicable statute of limitations, the Investigations Bureau Bureau supervisor should be consulted and the sexual assault victim shall be notified at least 60 days prior to the disposal (Penal Code § 680). Reasons for not analyzing biological evidence shall be documented in writing (Penal Code § 680.3).

802.6.4 DESTRUCTION OF FIREARMS AND OTHER WEAPONS

The Property and Evidence Section supervisor or the authorized designee shall develop and maintain guidelines and procedures relating to the destruction of firearms and other weapons that includes but is not limited to the following (Penal Code § 18005):

- (a) Identification of firearms and other weapons that need to be destroyed
- (b) Maintenance of records of firearms and other weapons that need to be destroyed, including entry into the Automated Firearms System, as applicable, and records of the destruction and disposal of those firearms and other weapons
- (c) Identification of any law enforcement agency that the Department contracts with or has an agreement with related to the storage or destruction of firearms or other weapons that outlines the responsibilities of this department and the other agency
 - 1. If the Department contracts with a third-party for destruction of firearms or other weapons, the contract must explicitly prohibit the sale of any firearm or weapon or any part or attachment to the firearm or weapon.

The Property and Evidence Section supervisor or the authorized designee should ensure guidelines and procedures relating to the destruction of firearms and other weapons are posted on the Culver City Police Department website (Penal Code § 18005).

802.7 INSPECTIONS OF THE EVIDENCE ROOM

- (a) On a monthly basis, the Property supervisor of the evidence custodian shall make an inspection of the evidence storage facilities and practices to ensure adherence to appropriate policies and procedures.
- (b) Unannounced inspections of evidence storage areas shall be conducted annually as directed by the Chief of Police.
- (c) An annual audit of evidence held by the Department shall be conducted by a Bureau Commander (as appointed by the Chief of Police) not routinely or directly connected with evidence control.

Culver City Police Department

Culver City PD Policy Manual

Property and Evidence Section

- (d) Whenever a change is made in personnel who have access to the evidence room, an inventory of all evidence/property should be made by an individual not associated to the property room or function to ensure that records are correct and all evidence property is accounted for.

802.8 POLICY

It is the policy of the Culver City Police Department to process and store all property in a manner that will protect it from loss, damage, or contamination, while maintaining documentation that tracks the chain of custody, the location of property, and its disposition.

Records Section

803.1 PURPOSE AND SCOPE

This policy establishes the guidelines for the operational functions of the Culver City Police Department Records Section. The policy addresses department file access and internal requests for case reports.

803.2 POLICY

It is the policy of the Culver City Police Department to maintain department records securely, professionally, and efficiently.

803.3 RESPONSIBILITIES

803.3.1 RECORDS SUPERVISOR

The Chief of Police shall appoint and delegate certain responsibilities to a Records Supervisor. The Records Supervisor shall be directly responsible to the Administration Bureau Bureau Commander or the authorized designee.

The responsibilities of the Records Supervisor include but are not limited to:

- (a) Overseeing the efficient and effective operation of the Records Section.
- (b) Scheduling and maintaining Records Section time records.
- (c) Supervising, training, and evaluating Records Section staff.
- (d) Maintaining and updating a Records Section procedure manual.
- (e) Ensuring compliance with established policies and procedures.
- (f) Supervising the access, use, and release of protected information (see the Protected Information Policy).
- (g) Establishing security and access protocols for case reports designated as sensitive, where additional restrictions to access have been implemented. Sensitive reports may include but are not limited to:
 1. Homicides.
 2. Cases involving department members or public officials.
 3. Any case where restricted access is prudent.

803.3.2 RECORDS SECTION

The responsibilities of the Records Section include but are not limited to:

- (a) Maintaining a records management system for case reports.
 1. The records management system should include a process for numbering, identifying, tracking, and retrieving case reports.
- (b) Entering case report information into the records management system.
 1. Modification of case reports shall only be made when authorized by a supervisor.

Culver City Police Department

Culver City PD Policy Manual

Records Section

- (c) Providing members of the Department with access to case reports when needed for investigation or court proceedings.
- (d) Maintaining compliance with federal, state, and local regulations regarding reporting requirements of crime statistics. This includes reporting statistical data to the California Department of Justice (DOJ) for:
 - 1. All officer-involved shootings and incidents involving use of force resulting in serious bodily injury (Government Code § 12525.2).
 - 2. Suspected hate crimes (Penal Code § 13023).
 - 3. Complaints of racial bias against officers (Penal Code § 13012; Penal Code § 13020).
 - 4. Civilian complaints made against officers (Penal Code § 832.5; Penal Code § 13012).
 - 5. Stop data required by Government Code § 12525.5 and 11 CCR 999.226.
 - (a) The reported information must not contain personally identifiable information of the person stopped or other information exempt from disclosure pursuant to Government Code § 12525.5 (11 CCR 999.228).
 - 6. Anti-reproductive rights crime information required by Penal Code § 13777.
- (e) Maintaining compliance with federal, state, and local regulations regarding criminal history reports and auditing.
- (f) Identifying missing case reports and notifying the responsible member's supervisor.
- (g) Establishing a process for collecting and submitting data to appropriate federal data collection authorities (e.g., FBI National Use-of-Force Data Collection, U.S. Department of Justice's National Law Enforcement Accountability Database), as applicable, for the following types of occurrences:
 - (a) Officer suicides
 - (b) Officer misconduct
 - (c) Uses of force
 - (d) Officer deaths or assaults
 - (e) Crime incidents
 - (f) Deaths in custody
- (h) Updating the Automated Firearms System to reflect any firearms relinquished to the Department and the subsequent disposition to the California DOJ pursuant to Penal Code § 34010 (Penal Code § 29810).
- (i) Entering into the Automated Firearms System information about each firearm that has been reported stolen, lost, found, recovered, held for safekeeping, surrendered in relation to a private party firearms transaction or registration, relinquished pursuant to a court order, or under observation, within seven calendar days of the precipitating event (Penal Code § 11108.2).

Culver City Police Department

Culver City PD Policy Manual

Records Section

- (j) Entering into the California DOJ automated property system descriptions of serialized property, or non-serialized property that has been uniquely inscribed, which has been reported stolen, lost, found, recovered, held for safekeeping, or under observation (Penal Code § 11108).
- (k) Maintaining compliance with quarterly California DOJ reporting requirements regarding the department's efforts to verify an individual listed in the Armed and Prohibited Persons System (APPS) is no longer in possession of a firearm (Penal Code § 29813).
- (l) Maintaining compliance with the state and California DOJ reporting requirements regarding the number of transfers of individuals to immigration authorities and offenses that allowed for the transfers (Government Code § 7284.6(c)(2)).
- (m) Transmitting data to the Joint Regional Information Exchange System on any suspected multi-mission extremist crimes.

803.3.3 RECORDS SECTION PROCEDURE MANUAL

The Records Supervisor should establish procedures that address:

- (a) Identifying by name persons in reports.
- (b) Classifying reports by type of incident or crime.
- (c) Tracking reports through the approval process.
- (d) Assigning alpha-numerical records to all arrest records.
- (e) Managing a warrant and wanted persons file.

803.4 DETERMINATION OF FACTUAL INNOCENCE

In any case where a person has been arrested by officers of the Culver City Police Department and no accusatory pleading has been filed, the person arrested may petition the Department to destroy the related arrest records. Petitions should be forwarded to the Custodian of Records. The Custodian of Records shall review the case and determine if the petitioner is factually innocent of the charges (Penal Code § 851.8). Factual innocence means the accused person did not commit the crime.

Upon determination that a finding of factual innocence is appropriate, the Custodian of Records shall ensure that the arrest record and petition are sealed for later destruction and the required notifications are made to the California DOJ and other law enforcement agencies (Penal Code § 851.8).

The Custodian of Records should respond to a petition with the Department's decision within 45 days of receipt. Responses should include only the decision of the Department, not an explanation of the analysis leading to the decision.

803.5 ARREST WITHOUT FILING OF ACCUSATORY PLEADING

The Operations Bureau Commander should ensure a process is in place for when an individual is arrested and released and no accusatory pleading is filed so that the following occurs (Penal Code § 849.5; Penal Code § 851.6):

Culver City Police Department

Culver City PD Policy Manual

Records Section

- (a) The individual is issued a certificate describing the action as a detention.
- (b) All references to an arrest are deleted from the arrest records of the Department and the record reflects only a detention.
- (c) The California DOJ is notified.

803.6 FILE ACCESS AND SECURITY

The security of files in the Records Section must be a high priority and shall be maintained as mandated by state or federal law. All case reports including but not limited to initial, supplemental, follow-up, evidence, and any other reports related to a police department case, including field interview (FI) cards, criminal history records, and publicly accessible logs, shall be maintained in a secure area within the Records Section, accessible only by authorized members of the Records Section. Access to case reports or files when Records Section staff is not available may be obtained through the Watch Commander.

The Records Section will also maintain a secure file for case reports deemed by the Chief of Police as sensitive or otherwise requiring extraordinary access restrictions.

803.7 CONFIDENTIALITY

Records Section staff has access to information that may be confidential or sensitive in nature. Records Section staff shall not access, view, or distribute, or allow anyone else to access, view, or distribute any record, file, or report, whether in hard copy or electronic file format, or any other confidential, protected, or sensitive information except in accordance with the Records Maintenance and Release and Protected Information policies and the Records Section procedure manual.

Records Maintenance and Release

804.1 PURPOSE AND SCOPE

This policy provides guidance on the maintenance and release of department records. Protected information is separately covered in the Protected Information Policy.

804.1.1 MANAGER RESPONSIBILITIES

The Professional Standards Unit Lieutenant is responsible for the handling of all requests for personnel information (Pitchess Motions).

The Litigation Liaison/Records Manager Lieutenant is responsible for ensuring that all applicable laws related to public records requests are being adhered to by Culver City Police Department Employees.

804.2 POLICY

The Culver City Police Department is committed to providing public access to records in a manner that is consistent with the California Public Records Act (Government Code § 7920.000 et seq.).

804.3 CUSTODIAN OF RECORDS RESPONSIBILITIES

The Chief of Police shall designate a Custodian of Records. The responsibilities of the Custodian of Records include but are not limited to:

- (a) Managing the records management system for the Department, including the retention, archiving, release, and destruction of department public records.
- (b) Maintaining and updating the department records retention schedule including:
 1. Identifying the minimum length of time the Department must keep records.
 2. Identifying the department bureau responsible for the original record.
- (c) Establishing rules regarding the inspection and copying of department public records as reasonably necessary for the protection of such records (Government Code § 7922.525; Government Code § 7922.530).
- (d) Identifying records or portions of records that are confidential under state or federal law and not open for inspection or copying.
- (e) Establishing rules regarding the processing of subpoenas for the production of records.
- (f) Ensuring a current schedule of fees for public records as allowed by law is available (Government Code § 7922.530).
- (g) Determining how the department's website may be used to post public records in accordance with Government Code § 7922.545.
- (h) Ensuring that all department current standards, policies, practices, operating procedures, and education and training materials are posted on the department website in accordance with Penal Code § 13650.

Culver City Police Department

Culver City PD Policy Manual

Records Maintenance and Release

- (i) Ensuring that public records posted on the Department website meet the requirements of Government Code § 7922.680 including but not limited to posting in an open format where a record may be retrieved, downloaded, indexed, and searched by a commonly used internet search application.
- (j) Ensuring that a list and description, when applicable, of enterprise systems (as defined by Government Code § 7922.700) is publicly available upon request and posted in a prominent location on the Department's website (Government Code § 7922.710; Government Code § 7922.720).

804.4 PROCESSING REQUESTS FOR PUBLIC RECORDS

Any department member who receives a request for any record shall route the request to the Custodian of Records or the authorized designee.

804.4.1 REQUESTS FOR RECORDS

Any member of the public, including the media and elected officials, may access unrestricted records of this department, during regular business hours by submitting a written and signed request that reasonably describes each record sought and paying any associated fees (Government Code § 7922.530).

The processing of requests for any record is subject to the following (Government Code § 7922.530; Government Code § 7922.535):

- (a) The Department is not required to create records that do not exist.
- (b) Victims of an incident or their authorized representative shall not be required to show proof of legal presence in the United States to obtain department records or information. If identification is required, a current driver's license or identification card issued by any state in the United States, a current passport issued by the United States or a foreign government with which the United States has a diplomatic relationship or current Matricula Consular card is acceptable (Government Code § 7923.655).
- (c) Either the requested record or the reason for non-disclosure will be provided promptly, but no later than 10 days from the date of request, unless unusual circumstances preclude doing so. If more time is needed, an extension of up to 14 additional days may be authorized by the Custodian of Records or the authorized designee. If an extension is authorized, the Department shall provide the requester written notice that includes the reason for the extension and the anticipated date of the response.
 - 1. When the request does not reasonably describe the records sought, the Custodian of Records shall assist the requester in making the request focused and effective in a way to identify the records or information that would be responsive to the request including providing assistance for overcoming any practical basis for denying access to the records or information. The Custodian of Records shall also assist in describing the information technology and physical location in which the record exists (Government Code § 7922.600).
 - 2. If the record requested is available on the department website, the requester may be directed to the location on the website where the record is posted. If the

Culver City Police Department

Culver City PD Policy Manual

Records Maintenance and Release

requester is unable to access or reproduce the record, a copy of the record shall be promptly provided.

- (d) Upon request, a record shall be provided in an electronic format utilized by the Department. Records shall not be provided only in electronic format unless specifically requested (Government Code § 7922.570; Government Code § 7922.580).
- (e) When a record contains material with release restrictions and material that is not subject to release restrictions, the restricted material shall be redacted and the unrestricted material released.
 - 1. A copy of the redacted release should be maintained in the case file for proof of what was actually released and as a place to document the reasons for the redactions. If the record is audio or video, a copy of the redacted audio/video release should be maintained in the department-approved media storage system and a notation should be made in the case file to document the release and the reasons for the redacted portions.
- (f) If a record request is denied in whole or part, the requester shall be provided a written response that includes the statutory exemption for withholding the record or facts that the public interest served by nondisclosure outweighs the interest served by disclosure. The written response shall also include the names, titles, or positions of each person responsible for the denial (Government Code § 7922.000; Government Code § 7922.540).

804.5 RELEASE RESTRICTIONS

Examples of release restrictions include:

- (a) Personal identifying information, including an individual's photograph; Social Security and driver identification numbers; name, address, and telephone number; and medical or disability information that is contained in any driver license record, motor vehicle record, or any department record, including traffic collision reports, are restricted except as authorized by the Department, and only when such use or disclosure is permitted or required by law to carry out a legitimate law enforcement purpose (18 USC § 2721; 18 USC § 2722).
- (b) Social Security numbers (Government Code § 7922.200).
- (c) Personnel records, medical records, and similar records that would involve an unwarranted invasion of personal privacy except as allowed by law (Government Code § 7927.700; Penal Code § 832.7; Penal Code § 832.8; Evidence Code § 1043 et seq.).
 - 1. Peace officer personnel records that are deemed confidential shall not be made public or otherwise released to unauthorized individuals or entities absent a valid court order.
 - 2. The identity of any officer subject to any criminal or administrative investigation shall not be released without the consent of the involved officer, prior approval of the Chief of Police, or as required by law.
- (d) Victim information that may be protected by statutes, including victims of certain crimes who have requested that their identifying information be kept confidential, victims who are minors, and victims of certain offenses (e.g., sex crimes or human trafficking (Penal

Culver City Police Department

Culver City PD Policy Manual

Records Maintenance and Release

Code § 293)). Addresses and telephone numbers of a victim or a witness shall not be disclosed to any arrested person or to any person who may be a defendant in a criminal action unless it is required by law (Government Code § 7923.615; Penal Code § 841.5).

1. Victims of certain offenses (e.g., domestic violence, sexual assault, stalking, human trafficking, elder and dependent adult abuse) or their representatives shall be provided, upon request and without charge, one copy of all incident report face sheets, one copy of all incident reports, a copy of any accompanying or related photographs of the victim's injuries, property damage, or any other photographs that are noted in the incident report, and a copy of 9-1-1 recordings, if any, pursuant to the requirements and time frames of Family Code § 6228.
 2. Victims of sexual assault, upon written request, shall be provided a free copy of the initial crime report regardless of whether the report has been closed. Personal identifying information may be redacted (Penal Code § 680.2(b)).
- (e) Video or audio recordings created during the commission or investigation of the crime of rape, incest, sexual assault, domestic violence, or child abuse that depicts the face, intimate body part, or voice of a victim of the incident except as provided by Government Code § 7923.750.
- (f) Information involving confidential informants, intelligence information, information that would endanger the safety of any person involved, or information that would endanger the successful completion of the investigation or a related investigation. This includes analysis and conclusions of investigating officers (Evidence Code § 1041; Government Code § 7923.605).
1. Absent a statutory exemption to the contrary or other lawful reason to deem information from reports confidential, information from unrestricted agency reports shall be made public as outlined in Government Code § 7923.605.
- (g) Local criminal history information including but not limited to arrest history and disposition, and fingerprints shall only be subject to release to those agencies and individuals set forth in Penal Code § 13300.
1. All requests from criminal defendants and their authorized representatives (including attorneys) shall be referred to the [District/CountyAttorney], the City Attorney, or the courts pursuant to Penal Code § 1054.5.
- (h) Certain types of reports involving but not limited to child abuse and molestation (Penal Code § 11167.5), elder and dependent abuse (Welfare and Institutions Code § 15633), and juveniles (Welfare and Institutions Code § 827).
- (i) Sealed autopsy and private medical information concerning a murdered child with the exceptions that allow dissemination of those reports to law enforcement agents, prosecutors, defendants, or civil litigants under state and federal discovery laws (Code of Civil Procedure § 130).
- (j) Information contained in applications for licenses to carry firearms or other files that indicates when or where the applicant is vulnerable or which contains medical or psychological information (Government Code § 7923.800).

Culver City Police Department

Culver City PD Policy Manual

Records Maintenance and Release

- (k) Traffic collision reports (and related supplemental reports) shall be considered confidential and subject to release only to the California Highway Patrol, Department of Motor Vehicles (DMV), other law enforcement agencies, and those individuals and their authorized representatives set forth in Vehicle Code § 20012.
- (l) Any record created exclusively in anticipation of potential litigation involving this department (Government Code § 7927.200).
- (m) Any memorandum from legal counsel until the pending litigation has been adjudicated or otherwise settled (Government Code § 7927.205).
- (n) Records relating to the security of the department's electronic technology systems (Government Code § 7929.210).
- (o) A record of a complaint, or the investigations, findings, or dispositions of that complaint if the complaint is frivolous, as defined by Code of Civil Procedure § 128.5, or if the complaint is unfounded (Penal Code § 832.7 (b)(9)).
- (p) Any other record not addressed in this policy shall not be subject to release where such record is exempt or prohibited from disclosure pursuant to state or federal law, including but not limited to provisions of the Evidence Code relating to privilege (Government Code § 7927.705).
- (q) Information connected with juvenile court proceedings or the detention or custody of a juvenile. Federal officials may be required to obtain a court order to obtain certain juvenile information (Welfare and Institutions Code § 827.9; Welfare and Institutions Code § 827.95; Welfare and Institutions Code § 831).

804.6 SUBPOENAS AND DISCOVERY REQUESTS

Any member who receives a subpoena duces tecum or discovery request for records should promptly contact a supervisor and the Custodian of Records for review and processing. While a subpoena duces tecum may ultimately be subject to compliance, it is not an order from the court that will automatically require the release of the requested information.

Generally, discovery requests and subpoenas from criminal defendants and their authorized representatives (including attorneys) should be referred to the District Attorney, City Attorney or the courts.

All questions regarding compliance with any subpoena duces tecum or discovery request should be promptly referred to legal counsel for the Department so that a timely response can be prepared.

804.7 RELEASED RECORDS TO BE MARKED

Each report of any written record released pursuant to this policy should be documented within the Records Management System (RMS) to indicate the department name and to whom the record was released.

Each audio/video recording released should include the department name and to whom the record was released.

Culver City Police Department

Culver City PD Policy Manual

Records Maintenance and Release

804.8 SEALED RECORD ORDERS

Sealed record orders received by the Department shall be reviewed for appropriate action by the Custodian of Records. The Custodian of Records shall seal such records as ordered by the court. Records may include but are not limited to a record of arrest, investigation, detention, or conviction. Once the record is sealed, members shall respond to any inquiry as though the record did not exist (Penal Code § 851.8; Welfare and Institutions Code § 781).

When an arrest record is sealed pursuant to Penal Code § 851.87, Penal Code § 851.90, Penal Code § 851.91, Penal Code § 1000.4, or Penal Code § 1001.9, the Records Supervisor shall ensure that the required notations on local summary criminal history information and police investigative reports are made. Sealed records may be disclosed or used as authorized by Penal Code § 851.92.

804.8.1 SEALING JUVENILE RECORDS

Upon receiving notice from a probation department to seal a citation, juvenile arrest records, or other related records pursuant to Welfare and Institutions Code § 786.5, the Records Supervisor should ensure that the records are sealed within 60 days of that notice and that the probation department is notified once the records have been sealed (Welfare and Institutions Code § 786.5).

Upon receiving a list of juvenile arrest records that are eligible to be sealed from the California Department of Justice (DOJ), the Records Supervisor or the authorized designee shall review the records identified in the list and determine if the records are eligible to be sealed in accordance with Welfare and Institutions Code § 781.2. Within six months of receiving the list, the Records Supervisor or the authorized designee shall electronically report to the DOJ which records were sealed (Welfare and Institutions Code § 781.2).

804.9 SECURITY BREACHES

The Records Supervisor shall ensure notice is given anytime there is a reasonable belief an unauthorized person has acquired either unencrypted personal identifying information or encrypted personal information along with the encryption key or security credential stored in any Department information system (Civil Code § 1798.29).

Notice shall be given as soon as reasonably practicable to all individuals whose information may have been acquired. The notification may be delayed if the Department determines that notification will impede a criminal investigation or any measures necessary to determine the scope of the breach and restore the reasonable integrity of the data system.

For the purposes of this requirement, personal identifying information includes an individual's first name or first initial and last name in combination with any one or more of the following (Civil Code § 1798.29):

- (a) Social Security number
 - 1. Driver license number, California identification card number, tax identification number, passport number, military identification number, or other unique

Culver City Police Department

Culver City PD Policy Manual

Records Maintenance and Release

identification number issued on a government document commonly used to verify the identity of a specific individual

2. Account number or credit or debit card number, in combination with any required security code, access code or password that would permit access to an individual's financial account
 3. Medical information
 4. Health insurance information
 5. Information or data collected by Automated License Plate Reader (ALPR) technology
 6. Unique biometric data
 7. Genetic data
- (b) A username or email address, in combination with a password or security question and answer that permits access to an online account

804.9.1 FORM OF NOTICE

- (a) The notice shall be written in plain language, be consistent with the format provided in Civil Code § 1798.29 and include, to the extent possible, the following:
1. The date of the notice.
 2. Name and contact information for the Culver City Police Department.
 3. A list of the types of personal information that were or are reasonably believed to have been acquired.
 4. The estimated date or date range within which the security breach occurred.
 5. Whether the notification was delayed as a result of a law enforcement investigation.
 6. A general description of the security breach.
 7. The toll-free telephone numbers and addresses of the major credit reporting agencies, if the breach exposed a Social Security number or a driver license or California identification card number.
- (b) The notice may also include information about what the Culver City Police Department has done to protect individuals whose information has been breached and may include information on steps that the person whose information has been breached may take to protect him/herself (Civil Code § 1798.29).
- (c) When a breach involves an online account, and only a username or email address in combination with either a password or security question and answer that would permit access to an online account, and no other personal information has been breached (Civil Code § 1798.29):
1. Notification may be provided electronically or in another form directing the person to promptly change either his/her password or security question and answer, as applicable, or to take other appropriate steps to protect the online

Culver City Police Department

Culver City PD Policy Manual

Records Maintenance and Release

account with the Department in addition to any other online accounts for which the person uses the same username or email address and password or security question and answer.

2. When the breach involves an email address that was furnished by the Culver City Police Department, notification of the breach should not be sent to that email address but should instead be made by another appropriate medium as prescribed by Civil Code § 1798.29.

804.9.2 MANNER OF NOTICE

- (a) Notice may be provided by one of the following methods (Civil Code § 1798.29):
 1. Written notice.
 2. Electronic notice if the notice provided is consistent with the provisions regarding electronic records and signatures set forth in 15 USC § 7001.
 3. Substitute notice if the cost of providing notice would exceed \$250,000, the number of individuals exceeds 500,000 or the Department does not have sufficient contact information. Substitute notice shall consist of all of the following:
 - (a) Email notice when the Department has an email address for the subject person.
 - (b) Conspicuous posting of the notice on the department's webpage for a minimum of 30 days.
 4. Notification to major statewide media and the California Information Security Office within the California Department of Technology.
- (b) If a single breach requires the Department to notify more than 500 California residents, the Department shall electronically submit a sample copy of the notification, excluding any personally identifiable information, to the Attorney General.

804.10 RELEASE OF AUDIO OR VIDEO RECORDINGS RELATED TO CRITICAL INCIDENTS

Video and audio recordings related to critical incidents shall be released upon a proper public record request and subject to delayed release, redaction, and other release restrictions as provided by law (Government Code § 7923.625).

For purposes of this section, a video or audio recording relates to a critical incident if it depicts an incident involving the discharge of a firearm at a person by an officer, or depicts an incident in which the use of force by an officer against a person resulted in death or in great bodily injury (as defined by Penal Code § 243(f)(4)) (Government Code § 7923.625).

The Custodian of Records should work as appropriate with the Chief of Police or the Professional Standards Unit supervisor in determining what recordings may qualify for disclosure when a request for a recording is received and if the requested recording is subject to delay from disclosure, redaction, or other release restrictions.

Culver City Police Department

Culver City PD Policy Manual

Records Maintenance and Release

804.10.1 DELAY OF RELEASE

Disclosure of critical incident recordings during active criminal or administrative investigations may be delayed as follows if disclosure would substantially interfere with the investigation, such as by endangering the safety of a witness or a confidential source:

- (a) Disclosure may be delayed up to 45 days from the date the Department knew or reasonably should have known about the incident.
- (b) Delay of disclosure may continue after the initial 45 days and up to one year if the Department demonstrates that disclosure would substantially interfere with the investigation.
- (c) Any delay of disclosure longer than one year must be supported by clear and convincing evidence that disclosure would substantially interfere with the investigation (Government Code § 7923.625).

804.10.2 NOTICE OF DELAY OF RELEASE

When there is justification to delay disclosure of a recording, the Custodian of Records shall provide written notice to the requester as follows (Government Code § 7923.625):

- (a) During the initial 45 days, the Custodian of Records shall provide the requester with written notice of the specific basis for the determination that disclosure would substantially interfere with the investigation. The notice shall also include the estimated date for the disclosure.
- (a) When delay is continued after the initial 45 days, the Custodian of Records shall promptly provide the requester with written notice of the specific basis for the determination that the interest in preventing interference with an active investigation outweighs the public interest in the disclosure, and the estimated date for the disclosure. The Custodian of Records should work with the Chief of Police in reassessing the decision to continue withholding a recording and notify the requester every 30 days.

Recordings withheld shall be disclosed promptly when the specific basis for withholding the recording is resolved.

804.10.3 REDACTION

If the Custodian of Records, in consultation with the Chief of Police or the authorized designee, determines that specific portions of the recording may violate the reasonable expectation of privacy of a person depicted in the recording, the Department should use redaction technology to redact portions of recordings made available for release. The redaction should not interfere with the viewer's ability to fully, completely, and accurately comprehend the events captured in the recording, and the recording should not otherwise be edited or altered (Government Code § 7923.625).

If any portions of a recording are withheld to protect the reasonable expectation of privacy of a person depicted in the recording, the Custodian of Records shall provide in writing to the requester the specific basis for the expectation of privacy and the public interest served (Government Code § 7923.625).

Culver City Police Department

Culver City PD Policy Manual

Records Maintenance and Release

804.10.4 RECORDINGS WITHHELD FROM PUBLIC DISCLOSURE

If the reasonable expectation of privacy of a person depicted in the recording cannot adequately be protected through redaction, and that interest outweighs the public interest in disclosure, the Department may withhold the recording from the public, except that the recording, either redacted or unredacted, shall be disclosed promptly, upon request, to any of the following (Government Code § 7923.625):

- (a) The person in the recording whose privacy is to be protected, or the person's authorized representative.
- (b) If the person is a minor, the parent or legal guardian of the person whose privacy is to be protected.
- (c) If the person whose privacy is to be protected is deceased, an heir, beneficiary, designated immediate family member, or authorized legal representative of the deceased person whose privacy is to be protected.

If the Department determines that this disclosure would substantially interfere with an active criminal or administrative investigation, the Custodian of Records shall provide the requester with written notice of the specific basis for the determination and the estimated date of disclosure (Government Code § 7923.625).

The Department may continue to delay release of the recording from the public for 45 days with extensions as provided in this policy (Government Code § 7923.625).

Protected Information

805.1 PURPOSE AND SCOPE

The purpose of this policy is to provide guidelines for the access, transmission, release and security of protected information by members of the Culver City Police Department. This policy addresses the protected information that is used in the day-to-day operation of the Department and not the public records information covered in the Records Maintenance and Release Policy.

805.1.1 DEFINITIONS

Definitions related to this policy include:

Protected information - Any information or data that is collected, stored or accessed by members of the Culver City Police Department and is subject to any access or release restrictions imposed by law, regulation, order or use agreement. This includes all information contained in federal, state or local law enforcement databases that is not accessible to the public.

805.2 POLICY

Members of the Culver City Police Department will adhere to all applicable laws, orders, regulations, use agreements and training related to the access, use, dissemination and release of protected information.

805.3 RESPONSIBILITIES

The Chief of Police shall select a member of the Department to coordinate the use of protected information.

The responsibilities of this position include, but are not limited to:

- (a) Ensuring member compliance with this policy and with requirements applicable to protected information, including requirements for the National Crime Information Center (NCIC) system, National Law Enforcement Telecommunications System (NLETS), Department of Motor Vehicle (DMV) records and California Law Enforcement Telecommunications System (CLETS).
- (b) Developing, disseminating and maintaining procedures that adopt or comply with the U.S. Department of Justice's current Criminal Justice Information Services (CJIS) Security Policy.
- (c) Developing, disseminating and maintaining any other procedures necessary to comply with any other requirements for the access, use, dissemination, release and security of protected information.
- (d) Developing procedures to ensure training and certification requirements are met.
- (e) Resolving specific questions that arise regarding authorized recipients of protected information.
- (f) Ensuring security practices and procedures are in place to comply with requirements applicable to protected information.

Culver City Police Department

Culver City PD Policy Manual

Protected Information

805.4 ACCESS TO PROTECTED INFORMATION

Protected information shall not be accessed in violation of any law, order, regulation, user agreement, Culver City Police Department policy or training. Only those members who have completed applicable training and met any applicable requirements, such as a background check, may access protected information, and only when the member has a legitimate work-related reason for such access.

Unauthorized access, including access for other than a legitimate work-related purpose, is prohibited and may subject a member to administrative action pursuant to the Personnel Complaints Policy and/or criminal prosecution.

805.4.1 PENALTIES FOR MISUSE OF RECORDS

It is a misdemeanor to furnish, buy, receive or possess Department of Justice criminal history information without authorization by law (Penal Code § 11143).

Authorized persons or agencies violating state regulations regarding the security of Criminal Offender Record Information (CORI) maintained by the California Department of Justice may lose direct access to CORI (11 CCR 702).

Each suspected incident of unauthorized or improper use of CLETS equipment or criminal justice information, or of failure to take physical security measures to protect CLETS equipment or criminal justice information, will be investigated by the department. Sustained violations could result in prosecution and/or disciplinary action up to and including termination.

805.4.2 RELEASE OF CORI

Only the persons listed below are authorized to release CORI. Each authorized person releasing CORI is responsible to ensure that each request granted appears legitimate and that the requester is an authorized recipient with a right and need to know.

- (a) Criminal Records Security Officer
- (b) Records Manager
- (c) Full-time employees of the Records Section
- (d) Personnel specifically designated in writing by Bureau Commanders with the concurrence of the Records Lieutenant

805.4.3 RELEASE OF CORI TO FIELD PERSONNEL

Personnel shall not have access to CORI until a background investigation has been completed and approved.

CORI shall not generally be transmitted by radio, cellular phone, or through computer terminals to field personnel or vehicles except in cases where circumstances reasonably indicate that the immediate safety of the officer or the public are at significant risk. Examples of situations where the transmission of summary criminal history information would be justified include a hostage

Culver City Police Department

Culver City PD Policy Manual

Protected Information

situation or an armed suspect however a routine investigation or traffic enforcement stop would not be sufficient justification.

Nothing in this procedure is intended to prohibit broadcasting warrant information concerning wanted persons.

805.5 RELEASE OR DISSEMINATION OF PROTECTED INFORMATION

Protected information may be released only to authorized recipients who have both a right to know and a need to know.

A member who is asked to release protected information that should not be released should refer the requesting person to a supervisor or to the Records Supervisor for information regarding a formal request.

Unless otherwise ordered or when an investigation would be jeopardized, protected information maintained by the Department may generally be shared with authorized persons from other law enforcement agencies who are assisting in the investigation or conducting a related investigation. Any such information should be released through the Records Section to ensure proper documentation of the release (see the Records Maintenance and Release Policy).

805.5.1 REVIEW OF CRIMINAL OFFENDER RECORD

Individuals requesting to review their own California criminal history information shall be referred to the Department of Justice (Penal Code § 11121).

Individuals shall be allowed to review their arrest or conviction record on file with the Department after complying with all legal requirements regarding authority and procedures in Penal Code § 11120 through Penal Code § 11127 (Penal Code § 13321).

805.5.2 TRANSMISSION GUIDELINES

Protected information, such as restricted Criminal Justice Information (CJI), which includes Criminal History Record Information (CHRI), should not be transmitted via unencrypted radio. When circumstances reasonably indicate that the immediate safety of officers, other department members, or the public is at risk, only summary information may be transmitted.

In cases where the transmission of protected information, such as Personally Identifiable Information, is necessary to accomplish a legitimate law enforcement purpose, and utilization of an encrypted radio channel is infeasible, a MDC or department-issued cellular telephone should be utilized when practicable. If neither are available, unencrypted radio transmissions shall be subject to the following:

- Elements of protected information should be broken up into multiple transmissions, to minimally separate an individual's combined last name and any identifying number associated with the individual, from either first name or first initial.
- Additional information regarding the individual, including date of birth, home address, or physical descriptors, should be relayed in separate transmissions.

Nothing in this policy is intended to prohibit broadcasting warrant information.

Culver City Police Department

Culver City PD Policy Manual

Protected Information

805.6 SECURITY OF PROTECTED INFORMATION

The Chief of Police will select a member of the Department to oversee the security of protected information.

The responsibilities of this position include, but are not limited to:

- (a) Developing and maintaining security practices, procedures and training.
- (b) Ensuring federal and state compliance with the CJIS Security Policy and the requirements of any state or local criminal history records systems.
- (c) Establishing procedures to provide for the preparation, prevention, detection, analysis and containment of security incidents including computer attacks.
- (d) Tracking, documenting and reporting all breach of security incidents to the Chief of Police and appropriate authorities.

805.6.1 MEMBER RESPONSIBILITIES

Members accessing or receiving protected information shall ensure the information is not accessed or received by persons who are not authorized to access or receive it. This includes leaving protected information, such as documents or computer databases, accessible to others when it is reasonably foreseeable that unauthorized access may occur (e.g., on an unattended table or desk; in or on an unattended vehicle; in an unlocked desk drawer or file cabinet; on an unattended computer terminal).

805.7 TRAINING

All members authorized to access or release protected information shall complete a training program that complies with any protected information system requirements and identifies authorized access and use of protected information, as well as its proper handling and dissemination.

805.7.1 COMPUTER TERMINAL SECURITY

Computer terminal equipment capable of providing access to automated criminal offender record information is located in the Records Section, watch commander's office, and in the Detective Bureau to preclude access by unauthorized persons. Computer terminals capable of accessing CORI shall not be housed or located anywhere on the premises that do not have controlled access, by either keyed entry, keypad-controlled entry, or 24/7 camera surveillance.

No employee shall be authorized to operate computer terminal equipment with access to CORI until the operator has completed the appropriate training.

805.7.2 DESTRUCTION OF CORI

When any document providing CORI has served the purpose for which it was obtained, it shall be destroyed and/or shredded in the following manner:

Culver City Police Department

Culver City PD Policy Manual

Protected Information

Printed material: Printed material shall be placed in Confidential Destroy bins and subsequently destroyed on-site by a contracted vendor while being supervised by a Culver City Police Department employee.

Electronic media: Electronic records on decommissioned servers or other storage devices shall be securely erased using DOD approved methods or the physical media shall be destroyed. Break/destroy the hard drive (ex. drill several holes through platters, shred, smash to point where platters and PCBs are broken, etc.)

CD/DVD media: Break/destroy CD/DVD media prior to being placed in Confidential Destroy bins for disposal by shredding.

Flash drives: Break/destroy the device. Electronic media may be placed in Confidential Destroy bins where a contracted vendor destroys them for the department while being supervised by a CCPD employee.

Transportation: Printed material, electronic media, or containers with CJI may only be handled or transported by approved persons who have been fingerprint background checked.

Storage: Printed material, electronic media, or containers with CJI may only be stored at approved locations staffed by persons who have been fingerprint background checked.

Each employee shall be responsible for destroying the CORI documents they receive.

805.7.3 CUSTODIAN OF CRIMINAL RECORDS

The Records Manager, unless otherwise directed by the Administration and Investigations Bureau Commander, shall be the Department's official Custodian of Criminal Records. The Custodian of Criminal Records shall be responsible for the security, storage, dissemination and destruction of criminal records, and will serve as a primary contact for the California Department of Justice for any related issues. The Administration and Investigations Bureau Commander may appoint other department employees to the role of Custodian of Criminal Records, who will share the same responsibilities regarding criminal records.

The Administration and Investigations Bureau Commander will ensure that he/she makes the appropriate applications and notifications to the California Department of Justice regarding the Department's Custodian of Criminal Record appointments, per the requirements of Penal Code § 11102.2.

This subsection is not intended to interfere with any other employee acting as a custodian of records for other statutory purposes but is narrowly tailored to address issues of criminal history records.

805.8 TRAINING PROGRAM

All personnel authorized to process or release CORI shall be required to complete a training program prescribed by the agency California Law Enforcement Telecommunication System (CLETS) Coordinator (ACC). The ACC shall coordinate the course to provide training in the proper use, control, and dissemination of CORI.

Culver City Police Department

Culver City PD Policy Manual

Protected Information

805.9 CALIFORNIA RELIGIOUS FREEDOM ACT

Members shall not release personal information from any agency database for the purpose of investigation or enforcement of any program compiling data on individuals based on religious belief, practice, affiliation, national origin or ethnicity (Government Code § 8310.3).

Animal Control

806.1 PURPOSE AND SCOPE

The purpose of this policy is to establish guidelines for interacting with animals and responding to calls for service that involve animals.

806.2 ANIMAL SERVICES OFFICER RESPONSIBILITIES

Animal control services are generally the primary responsibility of Animal Services Officer and include:

- (a) Animal-related matters during periods when Animal Services Officer is available.
- (b) Ongoing or persistent animal nuisance complaints. Such complaints may be scheduled, if reasonable, for handling during periods that Animal Services Officer is available for investigation and resolution.
- (c) Follow-up on animal-related calls, such as locating owners of injured animals.

806.3 MEMBER RESPONSIBILITIES

Members who respond to or assist with animal-related calls for service should evaluate the situation to determine the appropriate actions to control the situation.

Due to the hazards of handling animals without proper training and equipment, responding members generally should not attempt to capture or pick up any animal, but should keep the animal under observation until the arrival of appropriate assistance.

Members may consider acting before the arrival of such assistance when:

- (a) There is a threat to public safety.
- (b) An animal has bitten someone. Members should take measures to confine the animal and prevent further injury.
- (c) An animal is creating a traffic hazard.
- (d) An animal is seriously injured.
- (e) The owner/handler of an animal has been arrested or is incapacitated. In such circumstances, the member should find appropriate placement for the animal.
 - 1. This is only necessary when the arrestee is expected to be in custody for a time period longer than would reasonably allow him/her to properly care for the animal.
 - 2. With the owner's consent, locating appropriate placement may require contacting relatives or neighbors to care for the animal.
 - 3. If no person can be found or the owner does not or cannot give consent, the animal should be taken to a designated animal care facility.

Culver City Police Department

Culver City PD Policy Manual

Animal Control

806.4 DECEASED ANIMALS

When a member becomes aware of a deceased animal, all reasonable attempts should be made to preliminarily determine if the death of the animal is related to criminal activity.

Deceased animals on public property should be removed, sealed in a plastic bag, and properly disposed of by the responding member.

Members should not climb onto or under any privately owned structure for the purpose of removing a deceased animal.

When handling deceased animals, members should attempt to identify and notify the owner of the final disposition of the animal.

806.5 INJURED ANIMALS

When a member becomes aware of an injured domesticated animal, all reasonable attempts should be made to contact an owner or responsible handler. If an owner or responsible handler cannot be located, the animal should be taken to a veterinarian and notice shall be given to the owner pursuant to the requirements of Penal Code § 597.1.

806.5.1 VETERINARY CARE

The injured animal should be taken to a veterinarian as follows:

- (a) During normal business hours, the animal should be taken to an authorized veterinary care clinic.
- (b) If after normal business hours, the animal should be taken to the authorized Veterinary Emergency and Critical Care Services Clinic.
- (c) An exception to the above exists when the animal is an immediate danger to the community or the owner of the animal is identified and takes responsibility for the injured animal.

Each incident shall be documented and, at minimum, include the name of the reporting party and veterinary hospital and/or person to whom the animal is released.

If Animal Services Officer is not available, the information will be forwarded for follow-up.

806.5.2 INJURED WILDLIFE

Injured wildlife should be transferred to any city approved veterinary hospital. Once the animal is stabilized, it can be transported to the city approved animal shelter. Depending on the animal's condition, it can be taken directly to the shelter or released back into the wild.

806.5.3 RESCUE OF ANIMALS IN VEHICLES

If an animal left unattended in a vehicle appears to be in distress, members may enter the vehicle for the purpose of rescuing the animal. Members should (Penal Code § 597.7(d)):

- (a) Make a reasonable effort to locate the owner before entering the vehicle.
- (b) Take steps to minimize damage to the vehicle.

Culver City Police Department

Culver City PD Policy Manual

Animal Control

- (c) Refrain from searching the vehicle or seizing items except as otherwise permitted by law.
- (d) Leave notice on or in the vehicle identifying the location where the animal has been taken and the name and Department of the member involved in the rescue.
- (e) Make reasonable efforts to contact the owner or secure the vehicle before leaving the scene.
- (f) Take the animal to an animal care facility, a place of safekeeping or, if necessary, a veterinary hospital for treatment.

806.6 POLICY

It is the policy of the Culver City Police Department to be responsive to the needs of the community regarding animal-related issues. This includes enforcing local, state and federal laws relating to animals and appropriately resolving or referring animal-related problems, as outlined in this policy.

806.7 ANIMAL CRUELTY COMPLAINTS

Laws relating to the cruelty to animals should be enforced, including but not limited to Penal Code § 597 et seq. (cruelty to animals, failure to care for animals).

- (a) An investigation should be conducted on all reports of animal cruelty.
- (b) Legal steps should be taken to protect an animal that is in need of immediate care or protection from acts of cruelty.

806.8 ANIMAL BITE REPORTS

Members investigating an animal bite should obtain as much information as possible for follow-up with the appropriate health or animal authorities. Efforts should be made to capture or otherwise have the animal placed under control. Members should attempt to identify and notify the owner of the final disposition of the animal.

806.9 STRAY DOGS

If a stray dog has a license or can otherwise be identified, the owner should be contacted, if possible. If the owner is contacted, the dog should be released to the owner and a citation may be issued, if appropriate. If a dog is taken into custody, it shall be transported to the appropriate animal care facility.

Members shall provide reasonable treatment to animals in their care (e.g., food, water, shelter).

806.10 DANGEROUS ANIMALS

In the event responding members cannot fulfill a request for service because an animal is difficult or dangerous to handle, the Watch Commander will be contacted to determine available resources, including requesting the assistance of animal control services from the Los Angeles County Animal Care and Control.

Culver City Police Department

Culver City PD Policy Manual

Animal Control

806.11 PUBLIC NUISANCE CALLS RELATING TO ANIMALS

Members should diligently address calls related to nuisance animals (e.g., barking dogs), as such calls may involve significant quality-of-life issues.

806.12 DESTRUCTION OF ANIMALS

When it is necessary to use a firearm to euthanize a badly injured animal or stop an animal that poses an imminent threat to human safety, the Firearms Policy shall be followed. A badly injured animal shall only be euthanized with the approval of a supervisor.

Additional Support Units and Personnel

807.1 PURPOSE AND SCOPE

The purpose of this section is to identify Department entities that have been established to support the efficient functioning of the Department as well as enhance the quality of services provided to the community.

807.1.1 TYPES OF SUPPORT UNITS AND PERSONNEL

Support Units and Personnel include but are not limited to:

- (a) Crime Impact Team
- (b) K9 Unit
- (c) Special Enforcement Team (SET)
- (d) Mental Health Evaluation Team (CCMET)
- (e) Drone Team
- (f) Partnerships in Policing Team (PIP)
- (g) Emergency Response Team (ERT)
- (h) Crisis Negotiation Team (CNT)
- (i) Peer Support Unit
- (j) Community Service Officer
- (k) Crossing Guard Unit
- (l) Forensic Unit
- (m) Homeless Committee Sergeant
- (n) Honor Guard
- (o) Facility Maintenance
- (p) Automated Enforcement Section
- (q) Filming Permits
- (r) Law Enforcement Task Forces
- (s) Budget and Grants
- (t) School Resource Officer

Chapter 9 - Custody

Jail-Type One Facility

900.1 JAIL-TYPE ONE FACILITY

Refer to the Culver City Police Department's Jail Policy and Procedures Manual for all jail related policies. The manual is located in the jail.

Custodial Searches

901.1 PURPOSE AND SCOPE

This policy provides guidance regarding searches of individuals in custody. Such searches are necessary to eliminate the introduction of contraband, intoxicants, or weapons into the Culver City Police Department facility. Such items can pose a serious risk to the safety and security of department members, individuals in custody, contractors, and the public.

Guidance for custody searches when transporting a person in custody may be found in the Transporting Persons in Custody Policy.

Nothing in this policy is intended to prohibit the otherwise lawful collection of evidence from an individual in custody.

901.1.1 DEFINITIONS

Definitions related to this policy include:

Custody search - An in-custody search of an individual and of the individual's property, shoes, and clothing, including pockets, cuffs, and folds on the clothing, to remove all weapons, dangerous items, and contraband.

Physical body cavity search - A search that includes a visual inspection and may include a physical intrusion into a body cavity. Body cavity means the stomach, rectal cavity, or vagina of an individual.

Strip search - A search that requires an individual to remove or rearrange some or all of the individual's clothing to permit a visual inspection of the underclothing, breasts, buttocks, anus, or outer genitalia. This includes monitoring an individual who is changing clothes, where the individual's underclothing, buttocks, genitalia, or female breasts are visible.

901.2 POLICY

All searches shall be conducted with concern for safety, dignity, courtesy, respect for privacy and hygiene, and in compliance with policy and law to protect the rights of those who are subject to any search.

Searches shall not be used for intimidation, harassment, punishment or retaliation.

901.3 FIELD AND TRANSPORTATION SEARCHES

An officer should conduct a custody search of an individual immediately after the individual's arrest, when receiving an individual from the custody of another, and before transporting a person who is in custody in any department vehicle.

Whenever practicable, a custody search should be conducted by an officer of the same sex as the person being searched. If an officer of the same sex is not reasonably available, a witnessing officer should be present during the search.

Culver City Police Department

Culver City PD Policy Manual

Custodial Searches

901.4 SEARCHES AT POLICE FACILITIES

Custody searches shall be conducted on all individuals in custody, upon entry to the Culver City Police Department facilities. Except in exigent circumstances, the search should be conducted by a member of the same sex as the individual being searched. If a member of the same sex is not available, a witnessing member must be present during the search.

Custody searches should also be conducted any time an individual in custody enters or re-enters a secure area, or any time it is reasonably believed that a search is necessary to maintain the safety and security of the facility.

901.4.1 PROPERTY

Members shall take reasonable care in handling the property of an individual in custody to avoid discrepancies or losses. Property retained for safekeeping shall be kept in a secure location until the individual is released or transferred.

Some property may not be accepted by a facility or agency that is taking custody of an individual from this department, such as weapons or large items. These items should be retained for safekeeping in accordance with the Property and Evidence Policy.

All property shall be inventoried by objective description (this does not include an estimated value). The individual from whom it was taken shall be required to sign the completed inventory. If the individual's signature cannot be obtained, the inventory shall be witnessed by another department member. The inventory should include the case number, date, time, member's Culver City Police Department identification number and information regarding how and when the property may be released.

901.4.2 VERIFICATION OF MONEY

All money shall be counted in front of the individual from whom it was received. When possible, the individual shall initial the dollar amount on the inventory. Additionally, all money should be placed in a separate envelope and sealed. Negotiable checks or other instruments and foreign currency should also be sealed in an envelope with the amount indicated but not added to the cash total. All envelopes should clearly indicate the contents on the front. The department member sealing it should place the member's initials across the sealed flap. Should any money be withdrawn or added, the member making such change shall enter the amount below the original entry and initial it. The amount of money in the envelope should always be totaled and written on the outside of the envelope.

901.5 STRIP SEARCHES

No individual in temporary custody at any Culver City Police Department facility shall be subjected to a strip search unless there is reasonable suspicion based upon specific and articulable facts to believe the individual has a health condition requiring immediate medical attention or is concealing a weapon or contraband. Factors to be considered in determining reasonable suspicion include, but are not limited to:

Culver City Police Department

Culver City PD Policy Manual

Custodial Searches

- (a) The detection of an object during a custody search that may be a weapon or contraband and cannot be safely retrieved without a strip search.
- (b) Circumstances of a current arrest that specifically indicate the individual may be concealing a weapon or contraband.
 - 1. A felony arrest charge or being under the influence of a controlled substance should not suffice as reasonable suspicion absent other facts.
- (c) Custody history (e.g., past possession of contraband while in custody, assaults on department members, escape attempts).
- (d) The individual's actions or demeanor.
- (e) Criminal history (i.e., level of experience in a custody setting).

No transgender or intersex individual shall be searched or examined for the sole purpose of determining the individual's genital status. If the individual's genital status is unknown, it may be determined during conversations with the person, by reviewing medical records, or as a result of a broader medical examination conducted in private by a medical practitioner (28 CFR 115.115).

901.5.1 STRIP SEARCH PROCEDURES

Strip searches at Culver City Police Department facilities shall be conducted as follows (28 CFR 115.115; Penal Code § 4030):

- (a) Written authorization from the Watch Commander shall be obtained prior to the strip search.
- (b) All members involved with the strip search shall be of the same sex as the individual being searched, unless the search is conducted by a medical practitioner.
- (c) All strip searches shall be conducted in a professional manner under sanitary conditions and in a secure area of privacy so that it cannot be observed by those not participating in the search. The search shall not be reproduced through a visual or sound recording.
- (d) Whenever possible, a second member of the same sex should also be present during the search, for security and as a witness to the finding of evidence.
- (e) Members conducting a strip search shall not touch the breasts, buttocks, or genitalia of the individual being searched.
- (f) The primary member conducting the search shall prepare a written report to include:
 - 1. The facts that led to the decision to perform a strip search.
 - 2. The reasons less intrusive methods of searching were not used or were insufficient.
 - 3. The written authorization for the search, obtained from the Watch Commander.
 - 4. The name of the individual who was searched.
 - 5. The name and sex of the members who conducted the search.
 - 6. The name, sex, and role of any person present during the search.

Culver City Police Department

Culver City PD Policy Manual

Custodial Searches

7. The time and date of the search.
 8. The place at which the search was conducted.
 9. A list of the items, if any, that were recovered.
 10. The facts upon which the member based the member's belief that the individual was concealing a weapon or contraband.
- (g) No member should view an individual's private underclothing, buttocks, genitalia, or breasts while that individual is showering, performing bodily functions, or changing clothes, unless the individual would otherwise qualify for a strip search. However, if serious hygiene or health issues make it reasonably necessary to assist the individual with a shower or a change of clothes, a supervisor should be contacted to ensure reasonable steps are taken to obtain the individual's consent and/or otherwise protect the individual's privacy and dignity.
- (h) If the individual has been arrested for a misdemeanor or infraction offense, the written authorization from the Watch Commander shall include specific and articulable facts and circumstances upon which the reasonable suspicion determination for the search was made.
- (i) A copy of the written authorization shall be retained and made available upon request to the individual or the individual's authorized representative. A record of the time, date, place of the search, the name, and sex of the person conducting the search, and a statement of the results of the search shall also be retained and made available upon request to the individual or the individual's authorized representative.

901.5.2 SPECIAL CIRCUMSTANCE FIELD STRIP SEARCHES

A strip search may be conducted in the field only with Watch Commander authorization and only in exceptional circumstances, such as when:

- (a) There is probable cause to believe that the individual is concealing a weapon or other dangerous item that cannot be recovered by a more limited search.
- (b) There is probable cause to believe that the individual is concealing controlled substances or evidence that cannot be recovered by a more limited search, and there is no reasonable alternative to ensure the individual cannot destroy or ingest the substance during transportation.

These special-circumstance field strip searches shall only be authorized and conducted under the same restrictions as the strip search procedures in this policy, except that the Watch Commander authorization does not need to be in writing.

901.6 PHYSICAL BODY CAVITY SEARCH

Physical body cavity searches shall be subject to the following (Penal Code § 4030):

- (a) No individual shall be subjected to a physical body cavity search without written approval of the Watch Commander and only upon a search warrant. A copy of any search warrant and the results of the physical body cavity search shall be included with

Culver City Police Department

Culver City PD Policy Manual

Custodial Searches

the related reports and made available, upon request, to the individual or authorized representative (except for those portions of the warrant ordered sealed by a court).

- (b) Only a physician, nurse practitioner, registered nurse, licensed vocational nurse or Emergency Medical Technician Level II licensed to practice in California may conduct a physical body cavity search.
- (c) Except for the physician or licensed medical personnel conducting the search, persons present must be of the same sex as the individual being searched. Only the necessary department members needed to maintain the safety and security of the medical personnel shall be present.
- (d) Privacy requirements, including restricted touching of body parts and sanitary condition requirements, are the same as required for a strip search.
- (e) All such searches shall be documented, including:
 - 1. The facts that led to the decision to perform a physical body cavity search of the individual.
 - 2. The reasons less intrusive methods of searching were not used or were insufficient.
 - 3. The Watch Commander's approval.
 - 4. A copy of the search warrant.
 - 5. The time, date and location of the search.
 - 6. The medical personnel present.
 - 7. The names, sex and roles of any department members present.
 - 8. Any contraband or weapons discovered by the search.
- (f) Copies of the written authorization and search warrant shall be retained and shall be provided to the individual who was searched or other authorized representative upon request. A record of the time, date, place of the search, the name and sex of the person conducting the search and a statement of the results of the search shall also be retained and made available upon request to the individual or the individual's authorized representative.

901.7 TRAINING

The Personnel and Training Lieutenant shall ensure members have training that includes (28 CFR 115.115):

- (a) Conducting searches of cross-gender individuals.
- (b) Conducting searches of transgender and intersex individuals.
- (c) Conducting searches in a professional and respectful manner, and in the least intrusive manner possible, consistent with security needs.

Culver City Police Department

Culver City PD Policy Manual

Custodial Searches

901.8 BODY SCANNER SEARCH

If a body scanner is available, a body scan search should be performed on all persons in custody upon entering the secure booking area of the facility. Members (Penal Code § 4030):

- (a) Within sight of the visual display of a body scanner that is depicting the body during a scan shall be of the same sex as the person being scanned, except for physicians or licensed medical personnel.
- (b) Should ask persons in custody if they are pregnant prior to a body scan and should not knowingly use a body scanner on a pregnant person.

Prison Rape Elimination

902.1 PURPOSE AND SCOPE

This policy provides guidance for complying with the Prison Rape Elimination Act of 2003 (PREA) and the implementing regulation that establishes standards (PREA Rule) to prevent, detect, and respond to sexual abuse, harassment, and retaliation against individuals in custody in the Culver City Police Department Temporary Holding Facilities (28 CFR 115.111; 15 CCR 1029).

902.1.1 DEFINITIONS

Definitions related to this policy include:

Intersex - A person whose sexual or reproductive anatomy or chromosomal pattern does not seem to fit typical definitions of male or female. Intersex medical conditions are sometimes referred to as disorders of sex development (28 CFR 115.5).

Sexual abuse - Any of the following acts, if the detainee does not consent, is coerced into such act by overt or implied threats of violence, or is unable to consent or refuse (28 CFR 115.6; 15 CCR 1006):

- Contact between the penis and the vulva or the penis and the anus, including penetration, however slight
- Contact between the mouth and the penis, vulva, or anus
- Penetration of the anal or genital opening of another person, however slight, by a hand, finger, object, or other instrument
- Any other intentional touching, either directly or through the clothing, of the genitalia, anus, groin, breast, inner thigh, or the buttocks of another person, excluding contact incidental to a physical altercation

Sexual abuse also includes abuse by a staff member, contractor, or volunteer as follows, with or without consent of the individual in custody:

- Contact between the penis and the vulva or the penis and the anus, including penetration, however slight
- Contact between the mouth and the penis, vulva, or anus
- Contact between the mouth and any body part where the staff member, contractor, or volunteer has the intent to abuse, arouse, or gratify sexual desire
- Penetration of the anal or genital opening, however slight, by a hand, finger, object, or other instrument, that is unrelated to official duties, or where the staff member, contractor, or volunteer has the intent to abuse, arouse, or gratify sexual desire
- Any other intentional contact, either directly or through the clothing, of or with the genitalia, anus, groin, breast, inner thigh, or the buttocks, that is unrelated to official duties, or where the staff member, contractor, or volunteer has the intent to abuse, arouse, or gratify sexual desire

Culver City Police Department

Culver City PD Policy Manual

Prison Rape Elimination

- Any attempt, threat, or request by a staff member, contractor, or volunteer to engage in the activities described above
- Any display by a staff member, contractor, or volunteer of the staff member's uncovered genitalia, buttocks, or breast in the presence of an individual in custody
- Voyeurism by a staff member, contractor, or volunteer

Sexual harassment - Repeated and unwelcome sexual advances; requests for sexual favors; verbal comments, gestures, or actions of a derogatory or offensive sexual nature by an individual in custody that are directed toward another; repeated verbal comments or gestures of a sexual nature to an individual in custody by a staff member, contractor, or volunteer, including demeaning references to gender, sexually suggestive or derogatory comments about body or clothing, or obscene language or gestures (28 CFR 115.6; 15 CCR 1006).

Transgender - A person whose gender identity (i.e., internal sense of feeling male or female) is different from the person's assigned sex at birth (28 CFR 115.5).

902.2 POLICY

The Culver City Police Department has zero tolerance toward all forms of sexual abuse and sexual harassment (28 CFR 115.111). The Department will not tolerate retaliation against any person who reports sexual abuse or sexual harassment or who cooperates with a sexual abuse or sexual harassment investigation.

The Culver City Police Department will take immediate action to protect those in its custody who are reasonably believed to be subject to a substantial risk of imminent sexual abuse (28 CFR 115.162; 15 CCR 1029).

902.3 PREA COORDINATOR

The Chief of Police shall appoint an upper-level manager with sufficient time and authority to develop, implement, and oversee department efforts to comply with PREA standards in the Culver City Police Department Temporary Holding Facilities (28 CFR 115.111). The PREA Coordinator's responsibilities shall include:

- (a) Developing and maintaining procedures to comply with the PREA Rule.
- (b) Ensuring that any contract for the confinement of individuals in custody includes the requirement to adopt and comply with applicable PREA standards and the PREA Rule, including the obligation to provide incident-based and aggregated data, as required in 28 CFR 115.187 (28 CFR 115.112).
- (c) Developing a staffing plan to provide adequate levels of staffing and video monitoring, where applicable, in order to protect those in custody from sexual abuse (28 CFR 115.113; 15 CCR 1029). This includes documenting deviations and the reasons for deviations from the staffing plan, as well as reviewing the staffing plan a minimum of once per year.
- (d) Developing methods for staff to privately report sexual abuse and sexual harassment of individuals in custody (28 CFR 115.151).

Culver City Police Department

Culver City PD Policy Manual

Prison Rape Elimination

- (e) Developing a written plan to coordinate response among staff first responders, medical and mental health practitioners, investigators, and department leadership to an incident of sexual abuse (28 CFR 115.165).
- (f) Ensuring a protocol is developed for investigating allegations of sexual abuse in the Temporary Holding Facility. The protocol shall include (28 CFR 115.121; 28 CFR 115.122):
 - 1. Evidence collection practices that maximize the potential for obtaining usable physical evidence based on the most recent edition of the U.S. Department of Justice's (DOJ) Office on Violence Against Women publication, "A National Protocol for Sexual Assault Medical Forensic Examinations, Adults/Adolescents" or a similarly comprehensive and authoritative protocol.
 - 2. A process to ensure a criminal or administrative investigation is completed on all allegations of sexual abuse or sexual harassment.
 - 3. A process to document all referrals to other law enforcement agencies.
 - 4. Access to forensic medical examinations, without financial cost, for all victims of sexual abuse where appropriate. Such examinations shall be performed by Sexual Assault Forensic Examiners (SAFEs) or Sexual Assault Nurse Examiners (SANEs) where possible. If SAFEs or SANEs cannot be made available, the examination can be performed by other qualified medical practitioners. The efforts to provide SAFEs or SANEs shall be documented.
 - 5. In accordance with security needs, provisions to give, to the extent available, individuals in custody access to victim advocacy services if the individual is transported for a forensic examination to an outside hospital that offers such services.
- (g) Ensuring that individuals with limited English proficiency and disabilities have an equal opportunity to understand and benefit from efforts to prevent, detect, and respond to sexual abuse and sexual harassment. This includes, as appropriate, access to interpreters and written materials in formats or through methods that provide effective communication to those with disabilities (e.g., limited reading skills, intellectual, hearing, or vision disabilities) (28 CFR 115.116).
 - 1. The agency shall not rely on other individuals in custody for assistance except in limited circumstances where an extended delay in obtaining an interpreter could compromise the individual's safety, the performance of first-response duties under this policy, or the investigation of an individual's allegations of sexual abuse, harassment, or retaliation.
- (h) Publishing on the department's website:
 - 1. Information on how to report sexual abuse and sexual harassment on behalf of an individual in custody (28 CFR 115.154).
 - 2. A protocol describing the responsibilities of the Department and any other investigating agency that will be responsible for conducting sexual abuse or sexual harassment investigations (28 CFR 115.122).

Culver City Police Department

Culver City PD Policy Manual

Prison Rape Elimination

- (i) Establishing a process that includes the use of a standardized form and set of definitions to ensure accurate, uniform data is collected for every allegation of sexual abuse at facilities under this agency's direct control (28 CFR 115.187; 34 USC § 30303; 15 CCR 1041).
 - 1. The data collected shall include, at a minimum, the data necessary to answer all questions from the most recent version of the Survey of Sexual Violence, conducted by DOJ, or any subsequent form developed by DOJ and designated for lockups.
 - 2. The data shall be aggregated at least annually.
- (j) Ensuring audits are conducted pursuant to 28 CFR 115.401 through 28 CFR 115.405 for all Temporary Holding Facilities used to house individuals in custody overnight (28 CFR 115.193).
- (k) Ensuring contractors or others who work in the Temporary Holding Facility are informed of the agency's zero-tolerance policy regarding sexual abuse and sexual harassment (28 CFR 115.132).
- (l) Ensuring that information for uninvolved incarcerated persons, family, community members, and other interested third parties to report sexual abuse or sexual harassment is publicly posted at the facility (15 CCR 1029).

902.4 REPORTING SEXUAL ABUSE, HARASSMENT, AND RETALIATION

Individuals in custody may make reports to any staff member verbally, in writing, privately, or anonymously of any of the following (28 CFR 115.151; 15 CCR 1029):

- Sexual abuse
- Sexual harassment
- Retaliation by other individuals in custody or staff for reporting sexual abuse or sexual harassment
- Staff neglect or violation of responsibilities that may have contributed to sexual abuse or sexual harassment

Individuals in custody shall be notified of the department zero-tolerance policy regarding sexual abuse and sexual harassment, and of at least one way to report abuse or harassment to a public or private entity that is not part of the Department and that is able to receive and immediately forward a report of sexual abuse and sexual harassment to agency officials. This allows the individual to remain anonymous (28 CFR 115.132; 28 CFR 115.151).

902.4.1 MEMBER RESPONSIBILITIES

Department members shall accept reports from individuals in custody and third parties and shall promptly document all reports (28 CFR 115.151; 15 CCR 1029).

All members shall report immediately to the Watch Commander any knowledge, suspicion, or information regarding:

Culver City Police Department

Culver City PD Policy Manual

Prison Rape Elimination

- (a) An incident of sexual abuse or sexual harassment that occurs in the Temporary Holding Facility.
- (b) Retaliation against individuals in custody or the member who reports any such incident.
- (c) Any neglect or violation of responsibilities on the part of any department member that may have contributed to an incident or retaliation (28 CFR 115.161).

No member shall reveal any information related to a sexual abuse report to anyone other than to the extent necessary to make treatment and investigation decisions.

902.4.2 WATCH COMMANDER RESPONSIBILITIES

The Watch Commander shall report to the department's designated investigators all allegations of sexual abuse, harassment, retaliation, neglect, or violations leading to sexual abuse, harassment, or retaliation. This includes third-party and anonymous reports (28 CFR 115.161).

If the alleged victim is under the age of 18 or considered a vulnerable adult, the Watch Commander shall also report the allegation as required under mandatory reporting laws and department policy.

Upon receiving an allegation that an individual in custody was sexually abused while confined at another facility, the Watch Commander shall notify the head of the facility or the appropriate office of the agency where the alleged abuse occurred. The notification shall be made as soon as possible but no later than 72 hours after receiving the allegation. The Watch Commander shall document such notification (28 CFR 115.163).

If an alleged victim is transferred from the Temporary Holding Facility to a jail, prison, or medical facility, the Department shall, as permitted by law, inform the receiving facility of the incident and the individual's potential need for medical or social services, unless the individual requests otherwise (28 CFR 115.165).

902.5 INVESTIGATIONS

The Department shall promptly, thoroughly and objectively investigate all allegations, including third-party and anonymous reports, of sexual abuse or sexual harassment. Only investigators who have received department-approved special training shall conduct sexual abuse investigations (28 CFR 115.171).

902.5.1 FIRST RESPONDERS

The first officer to respond to a report of sexual abuse or sexual assault shall (28 CFR 115.164):

- (a) Separate the parties.
- (b) Establish a crime scene to preserve and protect any evidence. Identify and secure witnesses until steps can be taken to collect any evidence.
- (c) If the abuse occurred within a time period that still allows for the collection of physical evidence, request that the alleged victim not take any actions that could destroy physical evidence, including, as appropriate, washing, brushing teeth, changing clothes, urinating, defecating, smoking, drinking or eating.

Culver City Police Department

Culver City PD Policy Manual

Prison Rape Elimination

- (d) If the abuse occurred within a time period that still allows for the collection of physical evidence, ensure that the alleged abuser does not take any actions that could destroy physical evidence, including, as appropriate, washing, brushing teeth, changing clothes, urinating, defecating, smoking, drinking or eating.

If the first responder is not an officer the responder shall request that the alleged victim not take any actions that could destroy physical evidence and should then notify a law enforcement staff member (28 CFR 115.164).

902.5.2 INVESTIGATOR RESPONSIBILITIES

Investigators shall (28 CFR 115.171):

- (a) Gather and preserve direct and circumstantial evidence, including any available physical and biological evidence and any available electronic monitoring data.
- (b) Interview alleged victims, suspects, and witnesses.
- (c) Review any prior complaints and reports of sexual abuse involving the suspect.
- (d) Conduct compelled interviews only after consulting with prosecutors as to whether compelled interviews may be an obstacle for subsequent criminal prosecution.
- (e) Assess the credibility of the alleged victim, suspect, or witness on an individual basis and not by the person's status as a detainee or a member of the Culver City Police Department.
- (f) Document in written reports a description of physical, testimonial, documentary, and other evidence, the reasoning behind any credibility assessments, and investigative facts and findings.
- (g) Refer allegations of conduct that may be criminal to the District Attorney for possible prosecution, including any time there is probable cause to believe an individual in custody sexually abused another individual in custody in the Temporary Holding Facility (28 CFR 115.178).
- (h) Cooperate with outside investigators and remain informed about the progress of any outside investigation.

902.5.3 ADMINISTRATIVE INVESTIGATIONS

Administrative investigations shall include an effort to determine whether staff actions or failures to act contributed to the abuse. The departure of the alleged abuser or victim from the employment or control of this department shall not be used as a basis for terminating an investigation (28 CFR 115.171).

902.5.4 SEXUAL ASSAULT AND SEXUAL ABUSE VICTIMS

No individual in custody who alleges sexual abuse shall be required to submit to a polygraph examination or other truth-telling device as a condition for proceeding with the investigation of such an allegation (28 CFR 115.171(e)).

Victims of sexual abuse shall receive timely, unimpeded access to emergency medical treatment. Treatment services shall be provided to the victim without financial cost and regardless of whether

Culver City Police Department

Culver City PD Policy Manual

Prison Rape Elimination

the victim names the abuser or cooperates with any investigation arising out of the incident (28 CFR 115.182).

902.5.5 CONCLUSIONS AND FINDINGS

All completed investigations shall be forwarded to the Chief of Police, or if the allegations may reasonably involve the Chief of Police, to the City Council. The Chief of Police or the City Council shall review the investigation and determine whether any allegations of sexual abuse or sexual harassment have been substantiated by a preponderance of the evidence (28 CFR 115.172).

All personnel shall be subject to disciplinary sanctions up to and including termination for violating this policy. Termination shall be the presumptive disciplinary sanction for department members who have engaged in sexual abuse. All discipline shall be commensurate with the nature and circumstances of the acts committed, the member's disciplinary history, and the sanctions imposed for comparable offenses by other members with similar histories (28 CFR 115.176).

All terminations for violations of this policy, or resignations by members who would have been terminated if not for their resignation, shall be criminally investigated unless the activity was clearly not criminal and reported to any relevant licensing body (28 CFR 115.176).

Any contractor or volunteer who engages in sexual abuse shall be prohibited from contact with individuals in custody and reported to any relevant licensing bodies (28 CFR 115.177). The Chief of Police shall take appropriate remedial measures and consider whether to prohibit further contact with individuals in custody by a contractor or volunteer.

902.6 RETALIATION PROHIBITED

All individuals in custody and members who report sexual abuse or sexual harassment or who cooperate with sexual abuse or sexual harassment investigations shall be protected from retaliation (28 CFR 115.167). If any other individual who cooperates with an investigation expresses a fear of retaliation, appropriate measures shall be taken to protect that individual.

The Watch Commander or the authorized designee shall employ multiple protection measures, such as housing changes or transfers for victims or abusers, removal of alleged abusers from contact with victims, and emotional support services for individuals in custody or members who fear retaliation for reporting sexual abuse or sexual harassment or for cooperating with investigations.

The Watch Commander or the authorized designee shall identify a staff member to monitor the conduct and treatment of individuals in custody or members who have reported sexual abuse and of those who were reported to have suffered sexual abuse. The staff member shall act promptly to remedy any such retaliation. In the case of individuals in custody, such monitoring shall also include periodic status checks.

902.7 REVIEWS AND AUDITS

Culver City Police Department

Culver City PD Policy Manual

Prison Rape Elimination

902.7.1 INCIDENT REVIEWS

An incident review shall be conducted at the conclusion of every sexual abuse investigation, unless the allegation has been determined to be unfounded. The review should occur within 30 days of the conclusion of the investigation. The review team shall include upper-level management officials and seek input from line supervisors and investigators (28 CFR 115.186).

The review shall (28 CFR 115.186):

- (a) Consider whether the allegation or investigation indicates a need to change policy or practice to better prevent, detect or respond to sexual abuse.
- (b) Consider whether the incident or allegation was motivated by race; ethnicity; gender identity; lesbian, gay, bisexual, transgender or intersex identification, status or perceived status; gang affiliation; or was motivated or otherwise caused by other group dynamics at the facility.
- (c) Examine the area in the facility where the incident allegedly occurred to assess whether physical barriers in the area may enable abuse.
- (d) Assess the adequacy of staffing levels in that area during different shifts.
- (e) Assess whether monitoring technology should be deployed or augmented to supplement supervision by staff.

The review team shall prepare a report of its findings, including any determinations made pursuant to this section and any recommendations for improvement. The report shall be submitted to the Chief of Police and the PREA Coordinator. The Chief of Police or the authorized designee shall implement the recommendations for improvement or shall document the reasons for not doing so (28 CFR 115.186).

902.7.2 DATA REVIEWS

The facility shall conduct an annual review of collected and aggregated incident-based sexual abuse data. The review should include, as needed, data from incident-based documents, including reports, investigation files and sexual abuse incident reviews (28 CFR 115.187).

The purpose of these reviews is to assess and improve the effectiveness of sexual abuse prevention, detection and response policies, practices and training. An annual report shall be prepared that includes (28 CFR 115.188):

- (a) Identification of any potential problem areas.
- (b) Identification of any corrective actions taken.
- (c) Recommendations for any additional corrective actions.
- (d) A comparison of the current year's data and corrective actions with those from prior years.
- (e) An assessment of the Department's progress in addressing sexual abuse.

The report shall be approved by the Chief of Police and made readily available to the public through the department website or, if it does not have one, through other means. Material may be

Culver City Police Department

Culver City PD Policy Manual

Prison Rape Elimination

redacted from the reports when publication would present a clear and specific threat to the safety and security of the Temporary Holding Facility. However, the nature of the redacted material shall be indicated.

All aggregated sexual abuse data from Culver City Police Department facilities and private facilities with which it contracts shall be made readily available to the public at least annually through the department website or, if it does not have one, through other means. Before making aggregated sexual abuse data publicly available, all personal identifiers shall be removed (28 CFR 115.189).

902.8 RECORDS

The Department shall retain all written reports from administrative and criminal investigations pursuant to this policy for as long as the alleged abuser is held or employed by the Department, plus five years (28 CFR 115.171).

All other data collected pursuant to this policy shall be securely retained for at least 10 years after the date of the initial collection unless federal, state or local law requires otherwise (28 CFR 115.189).

902.9 TRAINING

All department members and contractors who may have contact with individuals in custody shall receive department-approved training on the prevention and detection of sexual abuse and sexual harassment within this facility. The Personnel and Training Lieutenant shall be responsible for developing and administering this training as appropriate, covering at a minimum (28 CFR 115.131):

- The Department's zero-tolerance policy and the right of individuals in custody to be free from sexual abuse and sexual harassment, and from retaliation for reporting sexual abuse or harassment.
- The dynamics of sexual abuse and harassment in confinement settings, including which individuals in custody are most vulnerable.
- The right of individuals in custody and staff members to be free from sexual abuse and sexual harassment, and from retaliation for reporting sexual abuse or harassment.
- Detecting and responding to signs of threatened and actual abuse.
- Communicating effectively and professionally with all individuals in custody.
- Compliance with relevant laws related to mandatory reporting of sexual abuse to outside authorities.

Investigators assigned to sexual abuse investigations shall also receive training in conducting such investigations in confinement settings. Training should include (28 CFR 115.134):

- Techniques for interviewing sexual abuse victims.
- Proper use of *Miranda* and *Garrity* warnings.
- Sexual abuse evidence collection in confinement settings.

Culver City Police Department

Culver City PD Policy Manual

Prison Rape Elimination

- Criteria and evidence required to substantiate a case for administrative action or prosecution referral.

The Personnel and Training Lieutenant shall maintain documentation that employees, volunteers, contractors, and investigators have completed required training and that they understand the training. This understanding shall be documented through individual signature or electronic verification.

All current department members who may have contact with individuals in custody shall be trained within one year of the effective date of the PREA standards. The agency shall provide annual refresher information to all such members to ensure that they understand the current sexual abuse and sexual harassment policies and procedures.

Chapter 10 - Personnel

Recruitment and Selection

1000.1 PURPOSE AND SCOPE

This policy provides a framework for employee recruiting efforts and identifying job-related standards for the selection process. This policy supplements the rules that govern employment practices for the Culver City Police Department and that are promulgated and maintained by the Personnel and Training.

1000.2 POLICY

In accordance with applicable federal, state, and local law, the Culver City Police Department provides equal opportunities for applicants and employees regardless of actual or perceived race, ethnicity, national origin, religion, sex, sexual orientation, gender identity or expression, age, disability, pregnancy, genetic information, veteran status, marital status, and any other classification or status protected by law. The Department does not show partiality or grant any special status to any applicant, employee, or group of employees unless otherwise required by law.

The Department will recruit and hire only those individuals who demonstrate a commitment to service and who possess the traits and characteristics that reflect personal integrity and high ethical standards.

1000.3 RECRUITMENT

The Administration Bureau Bureau Commander should employ a comprehensive recruitment and selection strategy to recruit and select employees from a qualified and diverse pool of candidates.

The strategy should include:

- (a) Identification of racially and culturally diverse target markets.
- (b) Use of marketing strategies to target diverse applicant pools.
- (c) Expanded use of technology and maintenance of a strong internet presence. This may include an interactive department website and the use of department-managed social networking sites, if resources permit.
- (d) Expanded outreach through partnerships with media, community groups, citizen academies, local colleges, universities, and the military.
- (e) Employee referral and recruitment incentive programs.
- (f) Consideration of shared or collaborative regional testing processes.

The Administration Bureau Bureau Commander shall avoid advertising, recruiting and screening practices that tend to stereotype, focus on homogeneous applicant pools or screen applicants in a discriminatory manner.

The Department should strive to facilitate and expedite the screening and testing process, and should periodically inform each candidate of his/her status in the recruiting process.

Culver City Police Department

Culver City PD Policy Manual

Recruitment and Selection

1000.4 SELECTION PROCESS

The Department shall actively strive to identify a diverse group of candidates who have in some manner distinguished themselves as being outstanding prospects. Minimally, the Department shall employ a comprehensive screening, background investigation, and selection process that assesses cognitive and physical abilities and includes review and verification of the following:

- (a) A comprehensive application for employment (including previous employment, references, current and prior addresses, education, military record)
 - 1. The personnel records of any applicant with prior peace officer experience in this state shall be requested from the appropriate law enforcement agency and reviewed prior to extending an offer of employment (Penal Code § 832.12).
 - 2. This includes review of prior law enforcement employment information maintained by POST (Penal Code § 13510.9).
- (b) Driving record
- (c) Personal and professional reference checks
- (d) Employment eligibility, including U.S. Citizenship and Immigration Services (USCIS) Employment Eligibility Verification Form I-9 and acceptable identity and employment authorization documents consistent with Labor Code § 1019.1. This required documentation should not be requested until a candidate is hired. This does not prohibit obtaining documents required for other purposes.
- (e) Information obtained from public internet sites
 - 1. This review should include the identification of any activity that promotes or supports unlawful violence or unlawful bias against persons based on protected characteristics (e.g., race, ethnicity, national origin, religion, gender, gender identity, sexual orientation, disability).
- (f) Financial history consistent with the Fair Credit Reporting Act (FCRA) (15 USC § 1681 et seq.)
- (g) Local, state, and federal criminal history record checks
- (h) Lie detector test (when legally permissible) (Labor Code § 432.2)
- (i) Medical and psychological examination (may only be given after a conditional offer of employment)
 - 1. The Medical Suitability Declaration (POST form 2-363) provided by the evaluating physician shall be maintained in the candidate's background investigation file (11 CCR 1954).
 - 2. The Psychological Suitability Declaration (POST form 2-364) provided by the evaluator shall be maintained in the candidate's background investigation file (11 CCR 1955).
- (j) Review board or selection committee assessment
- (k) Relevant national and state decertification records, if available, including the National Decertification Index

Culver City Police Department

Culver City PD Policy Manual

Recruitment and Selection

- (l) Any relevant information in the National Law Enforcement Accountability Database

1000.4.1 VETERAN'S PREFERENCE

Qualifying veterans of the United States Armed Forces who receive a passing score on an entrance examination shall be ranked in the top rank of any resulting eligibility list. The veteran's preference shall also apply to a widow or widower of a veteran or a spouse of a 100 percent disabled veteran (Government Code § 18973.1).

1000.5 BACKGROUND INVESTIGATION

Every candidate shall undergo a thorough background investigation to verify his/her personal integrity and high ethical standards, and to identify any past behavior that may be indicative of the candidate's unsuitability to perform duties relevant to the operation of the Culver City Police Department (11 CCR 1953).

The narrative report and any other relevant background information shall be shared with the psychological evaluator. Information shall also be shared with others involved in the hiring process if it is relevant to their respective evaluations (11 CCR 1953).

1000.5.1 NOTICES

Background investigators shall ensure that investigations are conducted and notices provided in accordance with the requirements of the FCRA and the California Investigative Consumer Reporting Agencies Act (15 USC § 1681d; Civil Code § 1786.16).

1000.5.2 STATE NOTICES

If information disclosed in a candidate's criminal offender record information (CORI) is the basis for an adverse employment decision, a copy of the CORI shall be provided to the applicant (Penal Code § 11105).

1000.5.3 REVIEW OF SOCIAL MEDIA SITES

All peace officer candidates shall be subject to a social media search for statements, postings, and/or endorsements made by the candidate that are relevant to suitability for peace officer employment, including bias-relevant information consistent with the requirements of 11 CCR 1955(d)(3) and any public expression of hate made in an online forum, as defined in Penal Code § 13680(g) (11 CCR 1953(e)(12)).

Due to the potential for accessing unsubstantiated, private, or protected information, the Administration Bureau Bureau Commander shall not require candidates to provide passwords, account information, or access to password-protected social media accounts (Labor Code § 980).

The Administration Bureau Bureau Commander should consider utilizing the services of an appropriately trained and experienced third party to conduct open source, internet-based searches, and/or review information from social media sites to ensure that:

- (a) The legal rights of candidates are protected.
- (b) Material and information to be considered are verified, accurate, and validated.

Culver City Police Department

Culver City PD Policy Manual

Recruitment and Selection

- (c) The Department fully complies with applicable privacy protections and local, state, and federal law.

Regardless of whether a third party is used, the Administration Bureau Bureau Commander should ensure that potentially impermissible information is not available to any person involved in the candidate selection process.

1000.5.4 DOCUMENTING AND REPORTING

The background investigator shall summarize the results of the background investigation in a narrative report that includes sufficient information to allow the reviewing authority to decide whether to extend a conditional offer of employment. The report shall include sections that summarize relevant Background Investigation Dimensions and include any findings of behaviors, traits, and/or attributes relevant to bias per the Bias Assessment Framework as described in the POST Background Investigation Manual. The report shall identify the data sources reviewed for the findings, regardless of weight given. The report shall include narrative information in the format described in 11 CCR 1953(g)(1). The report shall also include whether the candidate has engaged or is engaging in membership in a hate group, participation in hate group activity, or advocacy or public expressions of hate, pursuant to Penal Code § 13680 et seq. (11 CCR 1953).

The report shall not include any information that is prohibited from use, including that from social media sites, in making employment decisions. The report and all supporting documentation including relevant documentation of bias-related findings and documentation obtained through the social media search shall be included in the candidate's background investigation file (11 CCR 1953).

The background investigator shall document proof of verification of qualification for peace officer appointment on the Verification of Qualification for Peace Officer Appointment form and forward to the Administration Bureau Bureau Commander for final review and submission to POST (11 CCR 1953).

The background investigation file shall be made available during POST compliance inspections (11 CCR 1953).

1000.5.5 RECORDS RETENTION

The background report and all supporting documentation shall be maintained according to the established records retention schedule and at a minimum as follows (Government Code § 12946; 11 CCR 1953):

- (a) Reports and documentation for candidates hired by the Department shall be retained for the entire term of employment and a for a minimum of four years after separation from the Department.
- (b) Reports and documentation for candidates not hired by the Department for a minimum of four years.

Culver City Police Department

Culver City PD Policy Manual

Recruitment and Selection

1000.5.6 BACKGROUND INVESTIGATION UPDATE

A background investigation update may, at the discretion of the Chief of Police, be conducted in lieu of a complete new background investigation on a peace officer candidate who is reappointed within 180 days of voluntary separation from the Culver City Police Department, or who is an interim police chief meeting the requirements contained in 11 CCR 1953(f).

1000.5.7 INVESTIGATOR TRAINING

Background investigators shall complete POST-certified background investigation training prior to conducting investigations (11 CCR 1953; 11 CCR 1959).

1000.5.8 CONFIDENTIAL POST RECORDS

Records released to the Department from POST that were previously withheld from the candidate by POST shall be kept confidential as provided in Penal Code § 13510.9.

1000.6 DISQUALIFICATION GUIDELINES

As a general rule, performance indicators and candidate information and records shall be evaluated by considering the candidate as a whole, and taking into consideration the following:

- Age at the time the behavior occurred
- Passage of time
- Patterns of past behavior
- Severity of behavior
- Probable consequences if past behavior is repeated or made public
- Likelihood of recurrence
- Relevance of past behavior to public safety employment
- Aggravating and mitigating factors
- Other relevant considerations

A candidate's qualifications will be assessed on a case-by-case basis, using a totality-of-the-circumstances framework.

1000.7 EMPLOYMENT STANDARDS

All candidates shall meet the minimum standards required by state law (Government Code § 1029; Government Code § 1031; Penal Code § 13510.1; 11 CCR 1950 et seq.). Candidates will be evaluated based on merit, ability, competence, and experience, in accordance with the high standards of integrity and ethics valued by the Department and the community. The California Commission on Peace Officer Standards and Training (POST) developed a Job Dimensions list, which is used as a professional standard in background investigations.

Validated, job-related, and nondiscriminatory employment standards shall be established for each job classification and shall minimally identify the training, abilities, knowledge, and skills required to perform the position's essential duties in a satisfactory manner. Each standard should include

Culver City Police Department

Culver City PD Policy Manual

Recruitment and Selection

performance indicators for candidate evaluation. The Personnel and Training should maintain validated standards for all positions.

1000.7.1 STANDARDS FOR OFFICERS

Candidates shall meet the minimum standards established by POST or required by state law (Government Code § 1029; Government Code § 1031; 11 CCR 1950 et seq.):

- (a) Free of any felony convictions
- (b) Be legally authorized to work in the United States under federal law
- (c) At least 21 years of age except as provided by Government Code § 1031.4
- (d) Fingerprinted for local, state, and national fingerprint check
- (e) Good moral character as determined by a thorough background investigation (11 CCR 1953)
- (f) High school graduate, passed the GED or other high school equivalency test, or obtained a two-year, four-year, or advanced degree from an accredited or approved institution
- (g) Free from any physical, emotional, or mental condition, including bias against race or ethnicity, gender, nationality, religion, disability, or sexual orientation which might adversely affect the exercise of police powers (11 CCR 1954; 11 CCR 1955)
- (h) Free of hate group memberships, participation in hate group activities, or advocacy of public expressions of hate within the previous seven years, and since 18 years of age, as determined by a background investigation (Penal Code § 13681)
- (i) Candidates must also satisfy the POST selection requirements, including (11 CCR 1950 et seq.):
 - 1. Reading and writing ability assessment (11 CCR 1951)
 - 2. Oral interview to determine suitability for law enforcement service (11 CCR 1952)
- (j) POST certification that has not been revoked, denied, or voluntarily surrendered pursuant to Penal Code § 13510.8(f)
- (k) Not identified in the National Decertification Index of the International Association of Directors of Law Enforcement Standards and Training or similar federal government database that reflects revoked certification for misconduct or reflects misconduct that would result in a revoked certification in California.

In addition to the above minimum POST required standards, candidates may be subjected to additional standards established by the Department (Penal Code § 13510(d)).

1000.7.2 STANDARDS FOR DISPATCHER

Candidates shall satisfy the POST selection requirements, including (11 CCR 1956):

- (a) A verbal, reasoning, memory, and perceptual abilities assessment (11 CCR 1957)
- (b) An oral communication assessment (11 CCR 1958)

Culver City Police Department

Culver City PD Policy Manual

Recruitment and Selection

- (c) A medical evaluation (11 CCR 1960)

1000.8 PROBATIONARY PERIODS

The Administration Bureau Bureau Commander should coordinate with the Culver City Personnel and Training to identify positions subject to probationary periods and procedures for:

- (a) Appraising performance during probation.
- (b) Assessing the level of performance required to complete probation.
- (c) Extending probation.
- (d) Documenting successful or unsuccessful completion of probation.

Evaluation of Employees

1001.1 PURPOSE AND SCOPE

The Department's employee performance evaluation system is designed to record work performance for both the Department and the employee, providing recognition for good work and developing a guide for improvement.

1001.2 POLICY

The Culver City Police Department utilizes a performance evaluation report to measure performance and to use as a factor in making personnel decisions that relate to merit increases, promotion, reassignment, discipline, demotion, and termination. The evaluation report is intended to serve as a guide for work planning and review by the supervisor and employee. It gives supervisors a way to create an objective history of work performance based on job standards.

The Department evaluates employees in a non-discriminatory manner based upon job-related factors specific to the employee's position, without regard to actual or perceived race, ethnicity, national origin, religion, sex, sexual orientation, gender identity or expression, age, disability, pregnancy, genetic information, veteran status, marital status, and any other classification or status protected by law.

1001.3 EVALUATION PROCESS

Evaluation reports will cover a specific period of time and should be based on documented performance during that period. Evaluation reports will be completed by each employee's immediate supervisor. Other supervisors directly familiar with the employee's performance during the rating period should be consulted by the immediate supervisor for their input.

All sworn and professional staff supervisory personnel shall attend an approved supervisory course that includes training on the completion of performance evaluations within one year of the supervisory appointment.

Each supervisor should discuss the tasks of the position, standards of performance expected and the evaluation criteria with each employee at the beginning of the rating period. Supervisors should document this discussion in the prescribed manner.

Assessment of an employee's job performance is an ongoing process. Continued coaching and feedback provides supervisors and employees with opportunities to correct performance issues as they arise.

Non-probationary employees demonstrating substandard performance shall be notified in writing of such performance as soon as possible in order to have an opportunity to remediate the issues. Such notification should occur at the earliest opportunity, with the goal being a minimum of 90 days written notice prior to the end of the evaluation period.

Employees who disagree with their evaluation and who desire to provide a formal response or a rebuttal may do so in writing in the prescribed format and time period.

Culver City Police Department

Culver City PD Policy Manual

Evaluation of Employees

1001.3.1 RESERVE OFFICER EVALUATIONS

Reserve officer evaluations are covered under the Reserve Officers Policy.

1001.4 FULL TIME PROBATIONARY PERSONNEL

Professional Staff personnel are on probation for 12 months before being eligible for certification as permanent employees. An evaluation is completed quarterly for all full-time professional staff personnel during the probationary period.

Sworn personnel are on probation for 12 months before being eligible for certification as permanent employees. Probationary officers are evaluated daily and quarterly during the probationary period.

1001.5 FULL-TIME PERMANENT STATUS PERSONNEL

Permanent employees are subject to three types of performance evaluations:

Regular - An Employee Performance Evaluation shall be completed once each year by the employee's immediate supervisor on the anniversary of the employee's date of hire except for employees who have been promoted in which case an Employee Performance Evaluation shall be completed on the anniversary of the employee's date of last promotion.

Transfer - If an employee is transferred from one assignment to another in the middle of an evaluation period and less than six months have transpired since the transfer, then an evaluation shall be completed by the current supervisor with input from the previous supervisor.

Special - A special evaluation may be completed any time the rater and the rater's supervisor feel one is necessary due to employee performance that is deemed less than standard. Generally, the special evaluation will be the tool used to demonstrate those areas of performance deemed less than standard when follow-up action is planned (action plan, remedial training, retraining, etc.). The evaluation form and the attached documentation shall be submitted as one package.

1001.5.1 RATINGS

When completing the Employee Performance Evaluation, the rater will place a check mark in the column that best describes the employee's performance. The definition of each rating category is as follows:

Excellent - Is actual performance well beyond that required for the position. It is exceptional performance, definitely superior or extraordinary.

Very Good - Represents performance that is better than expected of a fully competent employee. It is superior to what is expected, but is not of such rare nature to warrant outstanding.

Satisfactory - Is the performance of a fully competent employee. It means satisfactory performance that meets the standards required of the position.

Needs Improvement - Is a level of performance less than that expected of a fully competent employee and less than standards required of the position. A needs improvement rating must be thoroughly discussed with the employee.

Culver City Police Department

Culver City PD Policy Manual

Evaluation of Employees

Unacceptable - Performance is inferior to the standards required of the position. It is very inadequate or undesirable performance that cannot be tolerated. An unacceptable rating must be thoroughly discussed with the employee.

Space for written comments is provided at the end of the evaluation in the rater comments section. This section allows the rater to document the employee's strengths, weaknesses, and suggestions for improvement. Any rating under satisfactory shall be substantiated in the rater comments section.

1001.6 EVALUATION INTERVIEW

When the supervisor has completed the preliminary evaluation, arrangements shall be made for a private discussion of the evaluation with the employee. The supervisor should discuss the results of the just completed rating period and clarify any questions the employee may have. If the employee has valid and reasonable protests of any of the ratings, the supervisor may make appropriate changes to the evaluation. Areas needing improvement and goals for reaching the expected level of performance should be identified and discussed. The supervisor should also provide relevant counseling regarding advancement, specialty positions and training opportunities. The supervisor and employee will sign and date the evaluation. Permanent employees may also write comments in the Employee Comments section of the performance evaluation report.

1001.6.1 DISCRIMINATORY HARASSMENT FORM

At the time of each employee's annual evaluation, the reviewing supervisor shall require the employee to read the City and Department harassment and discrimination policies. Following such policy review, the supervisor shall provide the employee a form to be completed and returned by the employee certifying the following:

- (a) That the employee understands the harassment and discrimination policies.
- (b) Whether any questions the employee has have been sufficiently addressed.
- (c) That the employee knows how and where to report harassment policy violations.
- (d) Whether the employee has been the subject of, or witness to, any conduct that violates the discrimination or harassment policy which has not been previously reported.

The completed form should be returned to the supervisor (or other authorized individual if the employee is uncomfortable returning the form to the presenting supervisor) within one week.

The employee's completed answers shall be attached to the evaluation. If the employee has expressed any questions or concerns, the receiving supervisor or other authorized individual shall insure that appropriate follow up action is taken.

1001.7 EVALUATION REVIEW

After the supervisor completes their assigned evaluation, the review process will begin as set forth by the City's Human Resources department with the use of NeoGov.

Culver City Police Department

Culver City PD Policy Manual

Evaluation of Employees

1001.8 EVALUATION DISTRIBUTION

The original performance evaluation shall be maintained by Human Resources within the evaluation program's on-line database. A copy will be given to the employee and is accessible by the employee on-line.

Grievance Procedure

1002.1 PURPOSE AND SCOPE

It is the policy of this department that all grievances be handled quickly and fairly without discrimination against employees who file a grievance whether or not there is a basis for the grievance. Our Department's philosophy is to promote a free verbal communication between employees and supervisors.

1002.1.1 GRIEVANCE DEFINED

A grievance is any difference of opinion concerning terms or conditions of employment or the dispute involving the interpretation or application of any of the following documents by the person(s) affected:

- The employee bargaining agreement (Memorandum of Understanding)
- This Policy Manual
- City rules and regulations covering personnel practices or working conditions

Grievances may be brought by an individual affected employee or by a group representative.

Specifically outside the category of grievance are complaints related to alleged acts of sexual, racial, ethnic or other forms of unlawful harassment, as well as complaints related to allegations of discrimination on the basis of sex, race, religion, ethnic background and other lawfully protected status or activity are subject to the complaint options set forth in the Discriminatory Harassment Policy, and personnel complaints consisting of any allegation of misconduct or improper job performance against any department employee that, if true, would constitute a violation of department policy, federal, state or local law set forth in the Personnel Complaint Policy.

1002.2 PROCEDURE

Except as otherwise required under a collective bargaining agreement, if an employee believes that he or she has a grievance as defined above, then that employee shall observe the following procedure:

- (a) Attempt to resolve the issue through informal discussion with immediate supervisor.
- (b) If after a reasonable amount of time, generally seven days, the grievance cannot be settled by the immediate supervisor, the employee may request an interview with the Bureau Commander of the affected bureau or bureau.
- (c) If a successful resolution is not found with the Bureau Commander, the employee may request a meeting with the Chief of Police.
- (d) If the employee and the Chief of Police are unable to arrive at a mutual solution, then the employee shall proceed as follows:

Culver City Police Department

Culver City PD Policy Manual

Grievance Procedure

1. Submit in writing a written statement of the grievance and deliver one copy to the Chief of Police and another copy to the immediate supervisor and include the following information:
 - (a) The basis for the grievance (i.e., what are the facts of the case?).
 - (b) Allegation of the specific wrongful act and the harm done.
 - (c) The specific policies, rules or regulations that were violated.
 - (d) What remedy or goal is being sought by this grievance.
- (e) The employee shall receive a copy of the acknowledgment signed by the supervisor including the date and time of receipt.
- (f) The Chief of Police will receive the grievance in writing. The Chief of Police and the City Council will review and analyze the facts or allegations and respond to the employee within 14 calendar days. The response will be in writing, and will affirm or deny the allegations. The response shall include any remedies if appropriate. The decision of the City Council is considered final.

1002.3 EMPLOYEE REPRESENTATION

Employees are entitled to have representation during the grievance process. The representative may be selected by the employee from the appropriate employee bargaining group.

1002.4 GRIEVANCE RECORDS

At the conclusion of the grievance process, all documents pertaining to the process shall be forwarded to Administration Bureau for inclusion into a secure file for all written grievances. A second copy of the written grievance will be maintained by the City Council's office to monitor the grievance process.

Reporting of Arrests, Convictions, and Court Orders

1003.1 PURPOSE AND SCOPE

The purpose of this policy is to describe the notification requirements and procedures that members must follow when certain arrests, convictions, and court orders restrict their ability to perform the official duties and responsibilities of the Culver City Police Department. This policy will also describe the notification requirements and procedures that certain retired officers must follow when an arrest, conviction, or court order disqualifies them from possessing a firearm.

1003.2 DOMESTIC VIOLENCE CONVICTIONS AND COURT ORDERS

Federal and California law prohibit individuals convicted of, or having an outstanding warrant for, certain offenses and individuals convicted of certain offenses and individuals subject to certain court orders from lawfully possessing firearms. Such convictions and court orders often involve allegations of the use or attempted use of force, or threatened use of a weapon on any individual in a domestic relationship (e.g., spouse, cohabitant, parent, child) (18 USC § 922; Penal Code § 29805).

All members and retired officers with identification cards issued by the Department are responsible for ensuring that they have not been disqualified from possessing firearms by any such conviction or court order, and shall promptly report any such conviction or court order to a supervisor, as provided in this policy.

1003.3 OTHER CRIMINAL CONVICTIONS AND COURT ORDERS

Government Code § 1029 prohibits any person convicted of a felony from being a peace officer in the State of California. This prohibition applies regardless of whether the guilt was established by way of a verdict, guilty, or nolo contendere plea.

Convictions of certain violations of the Vehicle Code and other provisions of law may also place restrictions on a member's ability to fully perform the duties of the job.

Outstanding warrants as provided in Penal Code § 29805 also place restrictions on a member's ability to possess a firearm.

While legal restrictions may or may not be imposed by statute or by the courts upon conviction of any criminal offense, criminal conduct by members of this department may be inherently in conflict with law enforcement duties and the public trust, and shall be reported as provided in this policy.

1003.4 REPORTING

All members and all retired officers with an identification card issued by the Department shall immediately notify their supervisors (retired officers should immediately notify the Watch Commander or the Chief of Police) in writing of any past or current criminal detention, arrest, charge, or conviction in any state or foreign country, regardless of whether or not the matter

Culver City Police Department

Culver City PD Policy Manual

Reporting of Arrests, Convictions, and Court Orders

was dropped or rejected, is currently pending or is on appeal, and regardless of the penalty or sentence, if any.

All members and all retired officers with an identification card issued by the Department shall further promptly notify their supervisors (retired officers should immediately notify the Watch Commander or the Chief of Police) in writing if they become the subject of a domestic violence-related order or any court order that prevents the member or retired officer from possessing a firearm or requires suspension or revocation of applicable POST certification.

Any member whose criminal arrest, conviction, or court order restricts or prohibits that member from fully and properly performing their duties, including carrying a firearm, may be disciplined. This includes but is not limited to being placed on administrative leave, reassignment, and/or termination. Any effort to remove such disqualification or restriction shall remain entirely the responsibility of the member, on the member's own time and expense.

Any member failing to provide prompt written notice pursuant to this policy shall be subject to discipline, up to and including termination.

Retired officers may have their identification cards rescinded or modified, as may be appropriate (see the Retiree Concealed Firearms Policy).

1003.4.1 NOTIFICATION REQUIREMENTS

The Administration Bureau Bureau Commander shall submit within 10 days of final disposition a notice to POST of a conviction or Government Code § 1029 reason that disqualifies any current peace officer employed by this department or any former peace officer if this department was responsible for the investigation (11 CCR 1003).

1003.5 POLICY

The Culver City Police Department requires disclosure of member arrests, convictions, and certain court orders to maintain the high standards, ethics, and integrity in its workforce, and to ensure compatibility with the duties and responsibilities of the Department.

Drug- and Alcohol-Free Workplace

1004.1 PURPOSE AND SCOPE

The purpose of this policy is to establish clear and uniform guidelines regarding drugs and alcohol in the workplace (41 USC § 8103).

1004.2 POLICY

It is the policy of this department to provide a drug- and alcohol-free workplace for all members.

1004.3 GENERAL GUIDELINES

Alcohol and drug use in the workplace or on department time can endanger the health and safety of department members and the public.

Members who have consumed an amount of an alcoholic beverage or taken any medication, or combination thereof, that would tend to adversely affect their mental or physical abilities shall not report for duty. Affected members shall notify the Watch Commander or appropriate supervisor as soon as the member is aware that the member will not be able to report to work. If the member is unable to make the notification, every effort should be made to have a representative contact the supervisor in a timely manner. If the member is adversely affected while on-duty, the member shall be immediately removed and released from work (see the Work Restrictions section in this policy).

1004.3.1 USE OF MEDICATIONS

Members should not use any medications that will impair their ability to safely and completely perform their duties. Any member who is medically required or has a need to take any such medication shall report that need to the member's immediate supervisor prior to commencing any on-duty status.

No member shall be permitted to work or drive a vehicle owned or leased by the Department while taking any medication that has the potential to impair the member's abilities, without a written release from the member's physician.

1004.3.2 MEDICAL OR RECREATIONAL CANNABIS

Possession, use, or being under the influence of medical or recreational cannabis on-duty is prohibited and may lead to disciplinary action. Members shall not smoke, ingest, or otherwise consume cannabis within 24 hours of reporting for duty.

1004.4 MEMBER RESPONSIBILITIES

Members shall report for work in an appropriate mental and physical condition. Members are prohibited from purchasing, manufacturing, distributing, dispensing, possessing or using controlled substances or alcohol on department premises or on department time (41 USC § 8103). The lawful possession or use of prescribed medications or over-the-counter remedies is excluded from this prohibition.

Members who are authorized to consume alcohol as part of a special assignment shall not do so to the extent of impairing on-duty performance.

Culver City Police Department

Culver City PD Policy Manual

Drug- and Alcohol-Free Workplace

Members shall notify a supervisor immediately if they observe behavior or other evidence that they believe demonstrates that a fellow member poses a risk to the health and safety of the member or others due to drug or alcohol use.

Members are required to notify their immediate supervisors of any criminal drug statute conviction for a violation occurring in the workplace no later than five days after such conviction (41 USC § 8103).

1004.5 EMPLOYEE ASSISTANCE PROGRAM

There may be available a voluntary employee assistance program to assist those who wish to seek help for alcohol and drug problems (41 USC § 8103). Insurance coverage that provides treatment for drug and alcohol abuse also may be available. Employees should contact the Human Resources, their insurance providers or the employee assistance program for additional information. It is the responsibility of each employee to seek assistance before alcohol or drug problems lead to performance problems.

1004.6 WORK RESTRICTIONS

If a member informs a supervisor that he/she has consumed any alcohol, drug or medication that could interfere with a safe and efficient job performance, the member may be required to obtain clearance from his/her physician before continuing to work.

If the supervisor reasonably believes, based on objective facts, that a member is impaired by the consumption of alcohol or other drugs, the supervisor shall prevent the member from continuing work and shall ensure that he/she is safely transported away from the Department.

1004.7 SCREENING TESTS

A supervisor may require an employee to submit to a screening under any of the following circumstances:

- (a) The supervisor reasonably believes, based upon objective facts, that the employee is under the influence of alcohol or drugs that are impairing the employee's ability to perform duties safely and efficiently.
- (b) The employee discharges a firearm in the performance of the employee's duties (excluding training or authorized euthanizing of an animal).
- (c) The employee discharges a firearm issued by the Department while off-duty, resulting in injury, death, or substantial property damage.
- (d) The employee drives a motor vehicle in the performance of the employee's duties and becomes involved in an incident that results in bodily injury, death, or substantial damage to property.

1004.7.1 SUPERVISOR RESPONSIBILITIES

The supervisor shall prepare a written record documenting the specific facts that led to the decision to require the test, and shall inform the employee in writing of the following:

- (a) The test will be given to detect either alcohol or drugs, or both.

Culver City Police Department

Culver City PD Policy Manual

Drug- and Alcohol-Free Workplace

- (b) The result of the test is not admissible in any criminal proceeding against the employee.
- (c) The employee may refuse the test, but refusal may result in dismissal or other disciplinary action.

1004.7.2 DISCIPLINE

An employee may be subject to disciplinary action if the employee:

- (a) Fails or refuses to submit to a screening test as requested.
- (b) After taking a screening test that indicates the presence of a controlled substance, fails to provide proof, within 72 hours after being requested, that the employee took the controlled substance as directed, pursuant to a current and lawful prescription issued in the employee's name.

1004.8 COMPLIANCE WITH THE DRUG-FREE WORKPLACE ACT

No later than 30 days following notice of any drug statute conviction for a violation occurring in the workplace involving a member, the Department will take appropriate disciplinary action, up to and including dismissal, and/or requiring the member to satisfactorily participate in a drug abuse assistance or rehabilitation program (41 USC § 8104).

1004.9 CONFIDENTIALITY

The Department recognizes the confidentiality and privacy due to its members. Disclosure of any information relating to substance abuse treatment, except on a need-to-know basis, shall only be with the express written consent of the member involved or pursuant to lawful process.

The written results of any screening tests and all documents generated by the employee assistance program are considered confidential medical records and shall be maintained in the member's confidential medical file in accordance with the Personnel Records Policy.

Sick Leave

1005.1 PURPOSE AND SCOPE

This policy provides general guidance regarding the use and processing of sick leave. The accrual and terms of use of sick leave for eligible employees are detailed in the City personnel manual or applicable collective bargaining agreement.

This policy is not intended to cover all types of sick or other leaves. For example, employees may be entitled to additional paid or unpaid leave for certain family and medical reasons as provided for in the Family and Medical Leave Act (FMLA) (29 USC § 2601 et seq.), the California Family Rights Act, leave for victims of crime or abuse, or for organ or bone marrow donor procedures (29 CFR 825; Government Code § 12945.2; Government Code § 12945.8; Labor Code § 1510).

1005.2 POLICY

It is the policy of the Culver City Police Department to provide eligible employees with a sick leave benefit.

1005.3 USE OF SICK LEAVE

Sick leave is intended to be used for qualified absences. Sick leave is not considered vacation. Abuse of sick leave may result in discipline, denial of sick leave benefits, or both.

Employees on sick leave shall not engage in other employment or self-employment or participate in any sport, hobby, recreational activity or other activity that may impede recovery from the injury or illness (see Outside Employment Policy).

Qualified appointments should be scheduled during a member's non-working hours when it is reasonable to do so.

1005.3.1 NOTIFICATION

All members should notify the Watch Commander or appropriate supervisor as soon as they are aware that they will not be able to report to work and no less than one hour before the start of their scheduled shifts. If, due to an emergency, a member is unable to contact the supervisor, every effort should be made to have a representative for the member contact the supervisor (Labor Code § 246).

When the necessity to be absent from work is foreseeable, such as planned medical appointments or treatments, the member shall, whenever possible and practicable, provide the Department with no less than 30 days' notice of the impending absence (Labor Code § 246).

Upon return to work, members are responsible for ensuring their time off was appropriately accounted for, and for completing and submitting the required documentation describing the type of time off used and the specific amount of time taken.

1005.4 EXTENDED ABSENCE

Members absent from duty for more than three consecutive days may be required to furnish a statement from a health care provider supporting the need to be absent and/or the ability to return

Culver City Police Department

Culver City PD Policy Manual

Sick Leave

to work. Members on an extended absence shall, if possible, contact their supervisor at specified intervals to provide an update on their absence and expected date of return.

Nothing in this section precludes a supervisor from requiring, with cause, a health care provider's statement for an absence of three or fewer days after the first three days of paid sick leave are used in a 12-month period.

1005.5 REQUIRED NOTICES

The Personnel and Training Lieutenant shall ensure:

- (a) Written notice of the amount of paid sick leave available is provided to employees as provided in Labor Code § 246.
- (b) A poster is displayed in a conspicuous place for employees to review that contains information on paid sick leave as provided in Labor Code § 247.

1005.6 SUPERVISOR RESPONSIBILITIES

The responsibilities of supervisors include, but are not limited to:

- (a) Monitoring and regularly reviewing the attendance of those under their command to ensure that the use of sick leave and absences is consistent with this policy.
- (b) Attempting to determine whether an absence of four or more days may qualify as family medical leave and consulting with legal counsel or the Personnel and Training as appropriate.
- (c) Addressing absences and sick leave use in the member's performance evaluation when excessive or unusual use has:
 1. Negatively affected the member's performance or ability to complete assigned duties.
 2. Negatively affected department operations.
- (d) When appropriate, counseling members regarding excessive absences and/or inappropriate use of sick leave.
- (e) Referring eligible members to an available employee assistance program when appropriate.

Communicable Diseases

1006.1 PURPOSE AND SCOPE

This policy provides general guidelines to assist in minimizing the risk of department members contracting and/or spreading communicable diseases.

1006.1.1 DEFINITIONS

Definitions related to this policy include:

Communicable disease - A human disease caused by microorganisms that are present in and transmissible through human blood, bodily fluid, tissue, or by breathing or coughing. These diseases commonly include, but are not limited to, hepatitis B virus (HBV), HIV and tuberculosis.

Exposure - When an eye, mouth, mucous membrane or non-intact skin comes into contact with blood or other potentially infectious materials, or when these substances are injected or infused under the skin; when an individual is exposed to a person who has a disease that can be passed through the air by talking, sneezing or coughing (e.g., tuberculosis), or the individual is in an area that was occupied by such a person. Exposure only includes those instances that occur due to a member's position at the Culver City Police Department. (See the exposure control plan for further details to assist in identifying whether an exposure has occurred.)

1006.2 POLICY

The Culver City Police Department is committed to providing a safe work environment for its members. Members should be aware that they are ultimately responsible for their own health and safety.

1006.3 EXPOSURE CONTROL OFFICER

The Chief of Police will assign a person as the Exposure Control Officer (ECO). The ECO shall develop an exposure control plan that includes:

- (a) Exposure-prevention and decontamination procedures.
- (b) Procedures for when and how to obtain medical attention in the event of an exposure or suspected exposure.
- (c) The provision that department members will have no-cost access to the appropriate personal protective equipment (PPE) (e.g., gloves, face masks, eye protection, pocket masks) for each member's position and risk of exposure.
- (d) Evaluation of persons in custody for any exposure risk and measures to separate them (15 CCR 1051; 15 CCR 1207).
- (e) Compliance with all relevant laws or regulations related to communicable diseases, including:
 1. Responding to requests and notifications regarding exposures covered under the Ryan White law (42 USC § 300ff-133; 42 USC § 300ff-136).
 2. Bloodborne pathogen mandates including (8 CCR 5193):

Culver City Police Department

Culver City PD Policy Manual

Communicable Diseases

- (a) Sharps injury log.
 - (b) Needleless systems and sharps injury protection.
 3. Airborne transmissible disease mandates including (8 CCR 5199):
 - (a) Engineering and work practice controls related to airborne transmissible diseases.
 - (b) Distribution of appropriate personal protective equipment to minimize exposure to airborne disease.
 4. Promptly notifying the county health officer regarding member exposures (Penal Code § 7510).
 5. Establishing procedures to ensure that members request exposure notification from health facilities when transporting a person that may have a communicable disease and that the member is notified of any exposure as required by Health and Safety Code § 1797.188.
 6. Informing members of the provisions of Health and Safety Code § 1797.188 (exposure to communicable diseases and notification).
- (f) Provisions for acting as the designated officer liaison with health care facilities regarding communicable disease or condition exposure notification. The designated officer should coordinate with other department members to fulfill the role when not available. The designated officer shall ensure that the name, title, and telephone number of the designated officer is posted on the Department website (Health and Safety Code § 1797.188).

The ECO should also act as the liaison with the Division of Occupational Safety and Health (Cal/ OSHA) and may request voluntary compliance inspections. The ECO shall annually review and update the exposure control plan and review implementation of the plan (8 CCR 5193).

1006.4 EXPOSURE PREVENTION AND MITIGATION

1006.4.1 GENERAL PRECAUTIONS

All members are expected to use good judgment and follow training and procedures related to mitigating the risks associated with communicable disease. This includes, but is not limited to (8 CCR 5193):

- (a) Stocking disposable gloves, antiseptic hand cleanser, CPR masks or other specialized equipment in the work area or department vehicles, as applicable.
- (b) Wearing department-approved disposable gloves when contact with blood, other potentially infectious materials, mucous membranes and non-intact skin can be reasonably anticipated.
- (c) Washing hands immediately or as soon as feasible after removal of gloves or other PPE.
- (d) Treating all human blood and bodily fluids/tissue as if it is known to be infectious for a communicable disease.

Culver City Police Department

Culver City PD Policy Manual

Communicable Diseases

- (e) Using an appropriate barrier device when providing CPR.
- (f) Using a face mask or shield if it is reasonable to anticipate an exposure to an airborne transmissible disease.
- (g) Decontaminating non-disposable equipment (e.g., flashlight, control devices, clothing and portable radio) as soon as possible if the equipment is a potential source of exposure.
 - 1. Clothing that has been contaminated by blood or other potentially infectious materials shall be removed immediately or as soon as feasible and stored/decontaminated appropriately.
- (h) Handling all sharps and items that cut or puncture (e.g., needles, broken glass, razors, knives) cautiously and using puncture-resistant containers for their storage and/or transportation.
- (i) Avoiding eating, drinking, smoking, applying cosmetics or lip balm, or handling contact lenses where there is a reasonable likelihood of exposure.
- (j) Disposing of biohazardous waste appropriately or labeling biohazardous material properly when it is stored.

1006.4.2 IMMUNIZATIONS

Members who could be exposed to HBV due to their positions may receive the HBV vaccine and any routine booster at no cost (8 CCR 5193).

1006.5 POST EXPOSURE

1006.5.1 INITIAL POST-EXPOSURE STEPS

Members who experience an exposure or suspected exposure shall:

- (a) Begin decontamination procedures immediately (e.g., wash hands and any other skin with soap and water, flush mucous membranes with water).
- (b) Obtain medical attention as appropriate.
- (c) Notify a supervisor as soon as practicable.

1006.5.2 REPORTING REQUIREMENTS

The supervisor on-duty shall investigate every exposure or suspected exposure that occurs as soon as possible following the incident. The supervisor shall ensure the following information is documented (8 CCR 5193):

- (a) Name and Social Security number of the member exposed
- (b) Date and time of the incident
- (c) Location of the incident
- (d) Potentially infectious materials involved and the source of exposure (e.g., identification of the person who may have been the source)
- (e) Work being done during exposure

Culver City Police Department

Culver City PD Policy Manual

Communicable Diseases

- (f) How the incident occurred or was caused
- (g) PPE in use at the time of the incident
- (h) Actions taken post-event (e.g., clean-up, notifications)

The supervisor shall advise the member that disclosing the identity and/or infectious status of a source to the public or to anyone who is not involved in the follow-up process is prohibited. The supervisor should complete the incident documentation in conjunction with other reporting requirements that may apply (see the Occupational Disease and Work-Related Injury Reporting Policy).

1006.5.3 MEDICAL CONSULTATION, EVALUATION AND TREATMENT

Department members shall have the opportunity to have a confidential medical evaluation immediately after an exposure and follow-up evaluations as necessary (8 CCR 5193).

The ECO should request a written opinion/evaluation from the treating medical professional that contains only the following information:

- (a) Whether the member has been informed of the results of the evaluation.
- (b) Whether the member has been notified of any medical conditions resulting from exposure to blood or other potentially infectious materials which require further evaluation or treatment.

No other information should be requested or accepted by the ECO.

1006.5.4 COUNSELING

The Department shall provide the member, and his/her family if necessary, the opportunity for counseling and consultation regarding the exposure (8 CCR 5193).

1006.5.5 SOURCE TESTING

Testing a person for communicable diseases when that person was the source of an exposure should be done when it is desired by the exposed member or when it is otherwise appropriate (8 CCR 5193). Source testing is the responsibility of the ECO. If the ECO is unavailable to seek timely testing of the source, it is the responsibility of the exposed member's supervisor to ensure testing is sought.

Source testing may be achieved by:

- (a) Obtaining consent from the individual.
- (b) Complying with the statutory scheme of Health and Safety Code § 121060. This includes seeking consent from the person who was the source of the exposure and seeking a court order if consent is not given.
- (c) Testing the exposed member for evidence of a communicable disease and seeking consent from the source individual to either access existing blood samples for testing or for the source to submit to testing (Health and Safety Code § 120262).
- (d) Taking reasonable steps to immediately contact the County Health Officer and provide preliminary information regarding the circumstances of the exposure and the status

Culver City Police Department

Culver City PD Policy Manual

Communicable Diseases

of the involved individuals to determine whether the County Health Officer will order testing (Penal Code § 7510).

- (e) Under certain circumstances, a court may issue a search warrant for the purpose of HIV testing a person when the exposed member qualifies as a crime victim (Penal Code § 1524.1).

Since there is the potential for overlap between the different manners in which source testing may occur, the ECO is responsible for coordinating the testing to prevent unnecessary or duplicate testing.

The ECO should seek the consent of the individual for testing and consult the City Attorney to discuss other options when no statute exists for compelling the source of an exposure to undergo testing if he/she refuses.

1006.6 CONFIDENTIALITY OF REPORTS

Medical information shall remain in confidential files and shall not be disclosed to anyone without the member's written consent (except as required by law). Test results from persons who may have been the source of an exposure are to be kept confidential as well.

1006.7 TRAINING

All members shall participate in training regarding communicable diseases commensurate with the requirements of their position. The training (8 CCR 5193):

- (a) Shall be provided at the time of initial assignment to tasks where an occupational exposure may take place and at least annually after the initial training.
- (b) Shall be provided whenever the member is assigned new tasks or procedures affecting his/her potential exposure to communicable disease.
- (c) Should provide guidance on what constitutes an exposure, what steps can be taken to avoid an exposure and what steps should be taken if a suspected exposure occurs.

Smoking and Tobacco Use

1007.1 PURPOSE AND SCOPE

This policy establishes limitations on smoking and the use of tobacco products by members and others while on-duty or while in Culver City Police Department facilities or vehicles.

For the purposes of this policy, smoking and tobacco use includes, but is not limited to, any tobacco product, such as cigarettes, cigars, pipe tobacco, snuff, tobacco pouches and chewing tobacco, as well as any device intended to simulate smoking, such as an electronic cigarette or personal vaporizer.

1007.2 POLICY

The Culver City Police Department recognizes that tobacco use is a health risk and can be offensive to others.

Smoking and tobacco use also presents an unprofessional image for the Department and its members. Therefore smoking and tobacco use is prohibited by members and visitors in all department facilities, buildings and vehicles, and as is further outlined in this policy (Government Code § 7597; Labor Code § 6404.5).

1007.3 SMOKING AND TOBACCO USE

Smoking and tobacco use by members is prohibited anytime members are in public view representing the Culver City Police Department.

It shall be the responsibility of each member to ensure that no person under his/her supervision smokes or uses any tobacco product inside City facilities and vehicles.

1007.4 ADDITIONAL PROHIBITIONS

No person shall use tobacco products within 20 feet of a main entrance, exit or operable window of any public building (including any department facility), or buildings on the campuses of the University of California, California State University and California community colleges, whether present for training, enforcement or any other purpose (Government Code § 7596 et seq.).

1007.4.1 NOTICE

The Chief of Police or the authorized designee should ensure that proper signage is posted at each entrance to the Department facility (Labor Code § 6404.5).

Personnel Complaints

1008.1 PURPOSE AND SCOPE

This policy provides guidelines for the reporting, investigation and disposition of complaints regarding the conduct of members of the Culver City Police Department. This policy shall not apply to any questioning, counseling, instruction, informal verbal admonishment or other routine or unplanned contact of a member in the normal course of duty, by a supervisor or any other member, nor shall this policy apply to a criminal investigation.

1008.2 POLICY

The Culver City Police Department takes seriously all complaints regarding the service provided by the Department and the conduct of its members.

The Department will accept and address all complaints of misconduct in accordance with this policy and applicable federal, state and local law, municipal and county rules and the requirements of any collective bargaining agreements.

It is also the policy of this department to ensure that the community can report misconduct without concern for reprisal or retaliation.

1008.3 PERSONNEL COMPLAINTS

Personnel complaints include any allegation of misconduct or improper job performance that, if true, would constitute a violation of department policy or of federal, state or local law, policy or rule. Personnel complaints may be generated internally or by the public.

Inquiries about conduct or performance that, if true, would not violate department policy or federal, state or local law, policy or rule may be handled informally by a supervisor and shall not be considered a personnel complaint. Such inquiries generally include clarification regarding policy, procedures or the response to specific incidents by the Department.

1008.3.1 COMPLAINT CLASSIFICATIONS

Personnel complaints shall be classified in one of the following categories:

Informal - A matter in which the Watch Commander is satisfied that appropriate action has been taken by a supervisor of rank greater than the accused member.

Formal - A matter in which a supervisor determines that further action is warranted. Such complaints may be investigated by a supervisor of rank greater than the accused member or referred to the Professional Standards Unit, depending on the seriousness and complexity of the investigation.

Incomplete - A matter in which the complaining party either refuses to cooperate or becomes unavailable after diligent follow-up investigation. At the discretion of the assigned supervisor or the Professional Standards Unit, such matters may be further investigated depending on the seriousness of the complaint and the availability of sufficient information.

Culver City Police Department

Culver City PD Policy Manual

Personnel Complaints

1008.3.2 SOURCES OF COMPLAINTS

The following applies to the source of complaints:

- (a) Individuals from the public may make complaints in any form, including in writing, by email, in person or by telephone.
- (b) Any department member becoming aware of alleged misconduct shall immediately notify a supervisor.
- (c) Supervisors shall initiate a complaint based upon observed misconduct or receipt from any source alleging misconduct that, if true, could result in disciplinary action.
- (d) Anonymous and third-party complaints should be accepted and investigated to the extent that sufficient information is provided.
- (e) Tort claims and lawsuits may generate a personnel complaint.

1008.4 AVAILABILITY AND ACCEPTANCE OF COMPLAINTS

1008.4.1 COMPLAINT FORMS

Personnel complaint forms will be maintained in a clearly visible location in the public area of the police facility and be accessible through the department website. Forms may also be available at other City facilities.

Personnel complaint forms in languages other than English may also be provided, as determined necessary or practicable.

1008.4.2 ACCEPTANCE

All complaints will be courteously accepted by any department member and promptly given to the appropriate supervisor. Although written complaints are preferred, a complaint may also be filed orally, either in person or by telephone. Such complaints will be directed to a supervisor. If a supervisor is not immediately available to take an oral complaint, the receiving member shall obtain contact information sufficient for the supervisor to contact the complainant. The supervisor, upon contact with the complainant, shall complete and submit a complaint form as appropriate.

Although not required, complainants should be encouraged to file complaints in person so that proper identification, signatures, photographs, or physical evidence may be obtained as necessary.

A complainant shall be provided with a copy of the complaining party's statement at the time it is filed with the Department (Penal Code § 832.7).

1008.4.3 AVAILABILITY OF WRITTEN PROCEDURES

The Department shall make available to the public a written description of the investigation procedures for complaints (Penal Code § 832.5).

1008.4.4 HATE COMPLAINTS AGAINST PEACE OFFICERS

Internal complaints or complaints from the public shall be accepted and investigated in accordance with this policy where it is alleged that an officer has in the previous seven years, and since 18

Culver City Police Department

Culver City PD Policy Manual

Personnel Complaints

years of age, engaged in membership in a hate group, participated in a hate group activity, or advocated any public expression of hate (Penal Code § 13682).

1008.5 DOCUMENTATION

Supervisors shall ensure that all formal and informal complaints are documented. The supervisor shall ensure that the nature of the complaint is defined as clearly as possible.

All complaints should also be documented in a log or software that records and tracks complaints. The log shall include the nature of the complaint and the actions taken to address the complaint. On an annual basis, the Department should audit the log and send an audit report to the Chief of Police or the authorized designee.

1008.6 ADMINISTRATIVE INVESTIGATIONS

Allegations of misconduct will be administratively investigated as follows.

1008.6.1 SUPERVISOR RESPONSIBILITIES

In general, the primary responsibility for the investigation of a personnel complaint shall rest with the member's immediate supervisor, unless the supervisor is the complainant, or the supervisor is the ultimate decision-maker regarding disciplinary action or has any personal involvement regarding the alleged misconduct. The Chief of Police or the authorized designee may direct that another supervisor investigate any complaint or refer the matter to the Professional Standards Unit (PSU).

A supervisor who becomes aware of alleged misconduct shall take reasonable steps to prevent aggravation of the situation.

The responsibilities of supervisors include but are not limited to:

- (a) Ensuring that upon receiving or initiating any formal complaint, documentation of the complaint is completed.
 - (a) The original complaint form or documentation will be directed to the Bureau Commander of the accused member, via the chain of command, who will take appropriate action and/or determine who will have responsibility for the investigation.
 - (b) In circumstances where the integrity of the investigation could be jeopardized by reducing the complaint to writing or where the confidentiality of a complainant is at issue, a supervisor shall orally report the matter to the member's Bureau Commander or the Chief of Police, who will initiate appropriate action.
- (b) Responding to all complainants in a courteous and professional manner.
- (c) Resolving those personnel complaints that can be resolved immediately.
 - (a) Follow-up contact with the complainant should be made within a reasonable timeframe of the Department receiving the complaint.
 - (b) If the matter is resolved and no further action is required, the supervisor will document the resolution of the complaint and forward it to the Bureau Commander.

Culver City Police Department

Culver City PD Policy Manual

Personnel Complaints

- (d) Ensuring that upon receipt of a complaint involving allegations of a potentially serious nature, the Bureau Commander and the Chief of Police are notified via the chain of command as soon as practicable.
- (e) Promptly contacting the Bureau Commander for direction regarding their roles in addressing a complaint that relates to sexual, racial, ethnic or other forms of prohibited harassment or discrimination.
- (f) Forwarding unresolved personnel complaints to the Bureau Commander, who will determine whether to contact the complainant or assign the complaint for investigation.
- (g) Informing the complainant of the investigator's name and the complaint number in a timely manner.
- (h) Investigating a complaint as follows:
 - 1. Making reasonable efforts to obtain names, addresses and telephone numbers of witnesses.
 - 2. When appropriate, ensuring immediate medical attention is provided and photographs of alleged injuries and accessible uninjured areas are taken.
- (i) Ensuring that the procedural rights of the accused member are followed (Government Code § 3303 et seq.).
- (j) Ensuring interviews of the complainant are generally conducted during reasonable hours.

1008.6.2 ADMINISTRATIVE INVESTIGATION PROCEDURES

Whether conducted by a supervisor or a member of the Professional Standards Unit, the following applies to members covered by the Public Safety Officers Procedural Bill of Rights Act (POBR) (Government Code § 3303):

- (a) Interviews of an accused member shall be conducted during reasonable hours and preferably when the member is on-duty. If the member is off-duty, he/she shall be compensated.
- (b) Unless waived by the member, interviews of an accused member shall be at the Culver City Police Department or other reasonable and appropriate place.
- (c) No more than two interviewers should ask questions of an accused member.
- (d) Prior to any interview, a member shall be informed of the nature of the investigation, the name, rank and command of the officer in charge of the investigation, the interviewing officers and all other persons to be present during the interview.
- (e) All interviews shall be for a reasonable period and the member's personal needs should be accommodated.
- (f) No member should be subjected to offensive or threatening language, nor shall any promises, rewards or other inducements be used to obtain answers.
- (g) Any member refusing to answer questions directly related to the investigation may be ordered to answer questions administratively and may be subject to discipline for failing to do so.

Culver City Police Department

Culver City PD Policy Manual

Personnel Complaints

1. A member should be given an order to answer questions in an administrative investigation that might incriminate the member in a criminal matter only after the member has been given a *Lybarger* advisement. Administrative investigators should consider the impact that compelling a statement from the member may have on any related criminal investigation and should take reasonable steps to avoid creating any foreseeable conflicts between the two related investigations. This may include conferring with the person in charge of the criminal investigation (e.g., discussion of processes, timing, implications).
 2. No information or evidence administratively coerced from a member may be provided to anyone involved in conducting the criminal investigation or to any prosecutor.
- (h) The interviewer should record all interviews of members and witnesses. The member may also record the interview. If the member has been previously interviewed, a copy of that recorded interview shall be provided to the member prior to any subsequent interview.
- (i) All members subjected to interviews that could result in discipline have the right to have an uninvolved representative present during the interview. However, in order to maintain the integrity of each individual's statement, involved members shall not consult or meet with a representative or attorney collectively or in groups prior to being interviewed.
- (j) All members shall provide complete and truthful responses to questions posed during interviews.
- (k) No member may be requested or compelled to submit to a polygraph examination, nor shall any refusal to submit to such examination be mentioned in any investigation (Government Code § 3307).

No investigation shall be undertaken against any officer solely because the officer has been placed on a prosecutor's *Brady* list or the name of the officer may otherwise be subject to disclosure pursuant to *Brady v. Maryland*. However, an investigation may be based on the underlying acts or omissions for which the officer has been placed on a *Brady* list or may otherwise be subject to disclosure pursuant to *Brady v. Maryland* (Government Code § 3305.5).

1008.6.3 ADMINISTRATIVE INVESTIGATION FORMAT

Formal investigations of personnel complaints shall be thorough, complete and essentially follow this format:

Findings - List a summary of all allegations and findings for each accused officer. Include any possible violations of state and/or federal law, department policy manual sections, and Culver City Civil Service Rules.

Introduction and Synopsis - Include the identity of the officers/members, the identity of the assigned investigators, the initial date and source of the complaint. Provide a brief summary of the facts giving rise to the investigation.

Investigation - Provide all details of your investigation, including:

Culver City Police Department

Culver City PD Policy Manual

Personnel Complaints

- Review of the complaint form.
- Review of any documentation and/or evidence gathered (i.e. crime reports, supervisor logs, lineups, etc.).
- Review of any captured MAV and/or BWC footage related to the incident.
- Review of any related 9-1-1 telephone call recordings.
- Review of any related police radio communications and accompanying CAD report.

Interviews - Interviews of all complainants, witnesses, and subject and/or witness officers. Although the recorded interview should be detailed and comprehensive, documentation of the interview may be reduced to a summary of relevant facts and should include:

- Service of a Notice of Administrative Interview to the subject/witness officers
- Completion of a department Personnel Investigation Subject/Witness Interview Checklist.
- Documentation that the interview was recorded (audio and/or video) and disposition of the recording.
- Documentation that the subject officer/member was offered legal and non-legal representation.

Conclusions - Conclusions reached after the completed investigation based on a preponderance of the evidence.

Exhibits - A separate list of exhibits (e.g., recordings, photos, documents) should be attached to the report.

Signature - Signature of the investigator.

1008.6.4 DISPOSITIONS

Each personnel complaint shall be classified with one of the following dispositions:

Unfounded - When the investigation discloses that the alleged acts did not occur or did not involve department members. Complaints that are determined to be frivolous will fall within the classification of unfounded (Penal Code § 832.8).

Exonerated - When the investigation discloses that the alleged act occurred but that the act was justified, lawful and/or proper.

Not sustained - When the investigation discloses that there is insufficient evidence to sustain the complaint or fully exonerate the member.

Sustained - A final determination by an investigating agency, commission, board, hearing officer, or arbitrator, as applicable, following an investigation and opportunity for an administrative appeal pursuant to Government Code § 3304 and Government Code § 3304.5 that the actions of an officer were found to violate law or department policy (Penal Code § 832.8).

Culver City Police Department

Culver City PD Policy Manual

Personnel Complaints

If an investigation discloses misconduct or improper job performance that was not alleged in the original complaint, the investigator shall take appropriate action with regard to any additional allegations.

1008.6.5 COMPLETION OF INVESTIGATIONS

Every investigator or supervisor assigned to investigate a personnel complaint or other alleged misconduct shall proceed with due diligence in an effort to complete the investigation within one year from the date of discovery by an individual authorized to initiate an investigation (Government Code § 3304).

In the event that an investigation cannot be completed within one year of discovery, the assigned investigator or supervisor shall ensure that an extension or delay is warranted within the exceptions set forth in Government Code § 3304(d) or Government Code § 3508.1.

1008.7 ADMINISTRATIVE SEARCHES

Assigned lockers, storage spaces and other areas, including desks, offices and vehicles, may be searched as part of an administrative investigation upon a reasonable suspicion of misconduct.

Such areas may also be searched any time by a supervisor for non-investigative purposes, such as obtaining a needed report, radio or other document or equipment.

Lockers and storage spaces may only be administratively searched in the member's presence, with the member's consent, with a valid search warrant or where the member has been given reasonable notice that the search will take place (Government Code § 3309).

1008.7.1 DISCLOSURE OF FINANCIAL INFORMATION

An employee may be compelled to disclose personal financial information under the following circumstances (Government Code § 3308):

- (a) Pursuant to a state law or proper legal process
- (b) Information exists that tends to indicate a conflict of interest with official duties
- (c) If the employee is assigned to or being considered for a special assignment with a potential for bribes or other improper inducements

1008.8 ADMINISTRATIVE LEAVE

When a complaint of misconduct is of a serious nature, or when circumstances indicate that allowing the accused to continue to work would adversely affect the mission of the Department, the Chief of Police or the authorized designee may temporarily assign an accused employee to administrative leave. Any employee placed on administrative leave:

- (a) May be required to relinquish any department badge, identification, assigned weapons and any other department equipment.
- (b) Shall be required to continue to comply with all policies and lawful orders of a supervisor.

Culver City Police Department

Culver City PD Policy Manual

Personnel Complaints

- (c) May be temporarily reassigned to a different shift, generally a normal business-hours shift, during the investigation. The employee may be required to remain available for contact at all times during such shift, and will report as ordered.

1008.9 CRIMINAL INVESTIGATION

Where a member is accused of potential criminal conduct, a separate supervisor or investigator shall be assigned to investigate the criminal allegations apart from any administrative investigation. Any separate administrative investigation may parallel a criminal investigation.

The Chief of Police shall be notified as soon as practicable when a member is accused of criminal conduct. The Chief of Police may request a criminal investigation by an outside law enforcement agency.

A member accused of criminal conduct shall be advised of his/her constitutional rights (Government Code § 3303(h)). The member should not be administratively ordered to provide any information in the criminal investigation.

The Culver City Police Department may release information concerning the arrest or detention of any member, including an officer, that has not led to a conviction. No disciplinary action should be taken until an independent administrative investigation is conducted.

1008.10 POST-ADMINISTRATIVE INVESTIGATION PROCEDURES

Upon completion of a formal investigation, an investigation report should be forwarded to the Chief of Police through the chain of command. Each level of command should review the report and include his/her comments in writing before forwarding the report. The Chief of Police may accept or modify any classification or recommendation for disciplinary action.

1008.10.1 DIVISION COMMANDER RESPONSIBILITIES

Upon receipt of any completed personnel investigation, the Bureau Commander of the involved member shall review the entire investigative file, the member's personnel file and any other relevant materials.

The Bureau Commander may make recommendations regarding the disposition of any allegations and the amount of discipline, if any, to be imposed.

Prior to forwarding recommendations to the Chief of Police, the Bureau Commander may return the entire investigation to the assigned investigator or supervisor for further investigation or action.

When forwarding any written recommendation to the Chief of Police, the Bureau Commander shall include all relevant materials supporting the recommendation. Actual copies of a member's existing personnel file need not be provided and may be incorporated by reference.

1008.10.2 CHIEF OF POLICE RESPONSIBILITIES

Upon receipt of any written recommendation for disciplinary action, the Chief of Police shall review the recommendation and all accompanying materials. The Chief of Police may modify any recommendation and/or may return the file to the Bureau Commander for further investigation or action.

Culver City Police Department

Culver City PD Policy Manual

Personnel Complaints

Once the Chief of Police is satisfied that no further investigation or action is required by staff, the Chief of Police shall determine the amount of discipline, if any, that should be imposed. In the event disciplinary action is proposed, the Chief of Police shall provide the member with a pre-disciplinary procedural due process hearing (*Skelly*) by providing written notice of the charges, proposed action and reasons for the proposed action. Written notice shall be provided within one year from the date of discovery of the misconduct (Government Code § 3304(d)). The Chief of Police shall also provide the member with:

- (a) Access to all of the materials considered by the Chief of Police in recommending the proposed discipline.
- (b) An opportunity to respond orally or in writing to the Chief of Police within five days of receiving the notice.
 - 1. Upon a showing of good cause by the member, the Chief of Police may grant a reasonable extension of time for the member to respond.
 - 2. If the member elects to respond orally, the presentation may be recorded by the Department. Upon request, the member shall be provided with a copy of the recording.

Once the member has completed his/her response or if the member has elected to waive any such response, the Chief of Police shall consider all information received in regard to the recommended discipline. The Chief of Police shall render a timely written decision to the member and specify the grounds and reasons for discipline and the effective date of the discipline. Once the Chief of Police has issued a written decision, the discipline shall become effective.

1008.10.3 NOTICE OF FINAL DISPOSITION TO THE COMPLAINANT

The Chief of Police or the authorized designee shall ensure that the complainant is notified of the disposition (i.e., sustained, not sustained, exonerated, unfounded) of the complaint (Penal Code § 832.7(f)).

1008.10.4 NOTICE REQUIREMENTS

The disposition of any civilian's complaint shall be released to the complaining party within 30 days of the final disposition. This release shall not include what discipline, if any, was imposed (Penal Code § 832.7(f)).

1008.11 PRE-DISCIPLINE EMPLOYEE RESPONSE

The pre-discipline process is intended to provide the accused employee with an opportunity to present a written or oral response to the Chief of Police after having had an opportunity to review the supporting materials and prior to imposition of any recommended discipline. The employee shall consider the following:

- (a) The response is not intended to be an adversarial or formal hearing.
- (b) Although the employee may be represented by an uninvolved representative or legal counsel, the response is not designed to accommodate the presentation of testimony or witnesses.

Culver City Police Department

Culver City PD Policy Manual

Personnel Complaints

- (c) The employee may suggest that further investigation could be conducted or the employee may offer any additional information or mitigating factors for the Chief of Police to consider.
- (d) In the event that the Chief of Police elects to cause further investigation to be conducted, the employee shall be provided with the results prior to the imposition of any discipline.
- (e) The employee may thereafter have the opportunity to further respond orally or in writing to the Chief of Police on the limited issues of information raised in any subsequent materials.

1008.12 RESIGNATIONS/RETIREMENTS PRIOR TO DISCIPLINE

In the event that a member tenders a written resignation or notice of retirement prior to the imposition of discipline, it shall be noted in the file. The tender of a resignation or retirement by itself shall not serve as grounds for the termination of any pending investigation or discipline (Penal Code § 13510.8). Investigations shall be completed if the employee resigns or is separated.

1008.13 POST-DISCIPLINE APPEAL RIGHTS

Non-probationary employees have the right to appeal a suspension without pay, punitive transfer, demotion, reduction in pay or step, or termination from employment. The employee has the right to appeal using the procedures established by any collective bargaining agreement, Memorandum of Understanding and/or personnel rules.

In the event of punitive action against an employee covered by the POBR, the appeal process shall be in compliance with Government Code § 3304 and Government Code § 3304.5.

During any administrative appeal, evidence that an officer has been placed on a *Brady* list or is otherwise subject to *Brady* restrictions may not be introduced unless the underlying allegations of misconduct have been independently established. Thereafter, such *Brady* evidence shall be limited to determining the appropriateness of the penalty (Government Code § 3305.5).

1008.14 PROBATIONARY EMPLOYEES AND OTHER MEMBERS

At-will and probationary employees and those members other than non-probationary employees may be released from employment for non-disciplinary reasons (e.g., failure to meet standards) without adherence to the procedures set forth in this policy or any right to appeal. However, any probationary officer subjected to an investigation into allegations of misconduct shall be entitled to those procedural rights, as applicable, set forth in the POBR (Government Code § 3303; Government Code § 3304).

At-will, probationary employees and those other than non-probationary employees subjected to discipline or termination as a result of allegations of misconduct shall not be deemed to have acquired a property interest in their position, but shall be given the opportunity to appear before the Chief of Police or authorized designee for a non-evidentiary hearing for the sole purpose of attempting to clear their name or liberty interest. There shall be no further opportunity for appeal beyond the liberty interest hearing and the decision of the Chief of Police shall be final.

Culver City Police Department

Culver City PD Policy Manual

Personnel Complaints

1008.15 RETENTION OF PERSONNEL INVESTIGATION FILES

All personnel complaints shall be maintained in accordance with the established records retention schedule and as described in the Personnel Records Policy.

1008.16 REQUIRED REPORTING TO POST

The Chief of Police or the authorized designee shall notify POST on the appropriate POST form within 10 days of certain officer personnel events, including but not limited to (Penal Code § 13510.9):

- (a) Termination or separation from employment or appointment. Separation from employment or appointment includes any involuntary termination, resignation, or retirement.
 - 1. A POST affidavit-of-separation form shall be executed and maintained by the Department and submitted to POST as required by Penal Code § 13510.9 and 11 CCR 1003.
- (b) Events that could affect an officer's POST certification, such as:
 - 1. Complaints, charges, or allegations of serious misconduct (as defined by Penal Code § 13510.8).
 - 2. Findings of civilian review boards.
 - 3. Final dispositions of any investigations.
 - 4. Civil judgments or court findings based on conduct, or settlement of a civil claim against an officer or the Culver City Police Department based on allegations of conduct by an officer.

The Chief of Police or the authorized designee shall be responsible for providing POST access to or duplication of investigation documentation (e.g., physical or documentary evidence, witness statements, analysis, conclusions) within the applicable timeframe provided in Penal Code § 13510.9.

1008.16.1 NOTIFICATIONS TO POST FOR SERIOUS MISCONDUCT

The Chief of Police or the authorized designee shall report allegations of serious misconduct by an officer to POST and the report shall include the following (11 CCR 1207):

- (a) Name of the Department
- (b) Administrative case number
- (c) Name, current address, and phone number of the complainant, if available
- (d) Name, POST ID, current address, and phone number of the involved officer
- (e) A summary of the alleged misconduct including:
 - 1. A narrative of the allegations
 - 2. Date and time of incidents
 - 3. Location of occurrence

Culver City Police Department

Culver City PD Policy Manual

Personnel Complaints

4. Any witness information, if available
 5. Summary of arrest or indictment of involved officer
- (f) A change in employment status of the involved officer (e.g., administrative leave, suspension, termination)
- (g) Name and contact information of the assigned investigator

The Chief of Police or the authorized designee shall provide updates of the investigation to POST every 90 days until the final disposition in the method designated by POST (11 CCR 1207).

Upon completion of the investigation, the Chief of Police or the authorized designee shall submit to POST the final disposition of the investigation as well as investigation materials and the officer's service record as provided by 11 CCR 1207.

1008.16.2 ADDITIONAL NOTIFICATIONS TO POST FOR SERIOUS MISCONDUCT

Additional notification shall be made to POST (11 CCR 1207):

- (a) If the imposed disciplinary action is pending appeal or other review through an administrative or judicial proceeding:
1. The Department shall provide the name of the body conducting the proceeding.
 2. The status of the proceeding, if known.
- (b) If criminal charges are pending:
1. The name of the court having jurisdiction over the criminal charges against the officer.
 2. The status of the criminal case, if known.

Seat Belts

1009.1 PURPOSE AND SCOPE

This policy establishes guidelines for the use of seat belts and child restraints. This policy will apply to all members operating or riding in department vehicles (Vehicle Code § 27315.5).

Guidance for transporting persons in custody may be found in the Transporting Persons in Custody and Handcuffing and Restraints policies.

1009.1.1 DEFINITIONS

Definitions related to this policy include:

Child restraint system - An infant or child passenger restraint system that meets Federal Motor Vehicle Safety Standards (FMVSS) and Regulations set forth in 49 CFR 571.213.

1009.2 WEARING OF SAFETY RESTRAINTS

All members shall wear properly adjusted safety restraints when operating or riding in a seat equipped with restraints, in any vehicle owned, leased or rented by this department while on- or off-duty, or in any privately owned vehicle while on-duty. The member driving such a vehicle shall ensure that all other occupants, including non-members, are also properly restrained.

Exceptions to the requirement to wear safety restraints may be made only in exceptional situations where, due to unusual circumstances, wearing a seat belt would endanger the member or the public. Members must be prepared to justify any deviation from this requirement.

1009.3 TRANSPORTING PERSONS IN CUSTODY

Persons who are in custody should be in a seated position and secured in the rear seat of any department vehicle with a restraint system or, when a restraint system is not available, by seat belts provided by the vehicle manufacturer. The restraint system is not intended to be a substitute for handcuffs or other appendage restraints.

An incarcerated person in leg restraints shall be transported in accordance with the Handcuffing and Restraints Policy.

1009.4 INOPERABLE SEAT BELTS

Department vehicles shall not be operated when the seat belt in the driver's position is inoperable. Persons shall not be transported in a seat in which the seat belt is inoperable.

Department vehicle seat belts shall not be modified, removed, deactivated or altered in any way, except by the vehicle maintenance and repair staff, who shall do so only with the express authorization of the Chief of Police.

Members who discover an inoperable restraint system shall report the defect to the appropriate supervisor. Prompt action will be taken to replace or repair the system.

Culver City Police Department

Culver City PD Policy Manual

Seat Belts

1009.5 POLICY

It is the policy of the Culver City Police Department that members use safety and child restraint systems to reduce the possibility of death or injury in a motor vehicle collision.

1009.6 TRANSPORTING CHILDREN

Children under the age of 8 shall be transported in compliance with California's child restraint system requirements (Vehicle Code § 27360; Vehicle Code § 27363).

Rear seat passengers in a cage-equipped vehicle may have reduced clearance, which requires careful seating and positioning of seat belts. Due to this reduced clearance, and if permitted by law, children and any child restraint system may be secured in the front seat of such vehicles provided this positioning meets federal safety standards and the vehicle and child restraint system manufacturer's design and use recommendations. In the event that a child is transported in the front seat of a vehicle, the seat should be pushed back as far as possible and the passenger-side airbag should be deactivated. If this is not possible, members should arrange alternate transportation when feasible. A child shall not be transported in a rear-facing child restraint system in the front seat in a vehicle that is equipped with an active frontal passenger airbag (Vehicle Code § 27363).

1009.7 VEHICLES MANUFACTURED WITHOUT SEAT BELTS

Vehicles manufactured and certified for use without seat belts or other restraint systems are subject to the manufacturer's operator requirements for safe use.

1009.8 VEHICLE AIRBAGS

In all vehicles equipped with airbag restraint systems, the system will not be tampered with or deactivated, except when transporting children as written elsewhere in this policy. All equipment installed in vehicles equipped with airbags will be installed as per the vehicle manufacturer specifications to avoid the danger of interfering with the effective deployment of the airbag device.

Body Armor

1010.1 PURPOSE AND SCOPE

The purpose of this policy is to provide law enforcement officers with guidelines for the proper use of body armor.

1010.2 POLICY

It is the policy of the Culver City Police Department to maximize officer safety through the use of body armor in combination with prescribed safety procedures. While body armor provides a significant level of protection, it is not a substitute for the observance of officer safety procedures.

1010.3 ISSUANCE OF BODY ARMOR

The Administration Bureau supervisor shall ensure that body armor is issued to all officers when the officer begins service at the Culver City Police Department and that, when issued, the body armor meets or exceeds the standards of the National Institute of Justice.

The Administration Bureau supervisor shall establish a body armor replacement schedule and ensure that replacement body armor is issued pursuant to the schedule or whenever the body armor becomes worn or damaged to the point that its effectiveness or functionality has been compromised.

1010.3.1 USE OF SOFT BODY ARMOR

Generally, the use of body armor is required subject to the following:

- (a) Officers shall only wear agency-approved body armor.
- (b) Officers shall wear body armor anytime they are in a situation where they could reasonably be expected to take enforcement action.
- (c) Officers may be excused from wearing body armor when they are functioning primarily in an administrative or support capacity and could not reasonably be expected to take enforcement action.
- (d) Body armor shall be worn when an officer is working in uniform or taking part in Department range training.
- (e) An officer may be excused from wearing body armor when he/she is involved in undercover or plainclothes work that his/her supervisor determines could be compromised by wearing body armor, or when a supervisor determines that other circumstances make it inappropriate to mandate wearing body armor.

1010.3.2 INSPECTIONS OF BODY ARMOR

Supervisors should ensure that body armor is worn and maintained in accordance with this policy through routine observation and periodic documented inspections. Annual inspections of body armor should be conducted by an authorized designee for fit, cleanliness, and signs of damage, abuse and wear.

Culver City Police Department

Culver City PD Policy Manual

Body Armor

1010.3.3 CARE AND MAINTENANCE OF SOFT BODY ARMOR

Soft body armor should never be stored for any period of time in an area where environmental conditions (e.g., temperature, light, humidity) are not reasonably controlled (e.g., normal ambient room temperature/humidity conditions), such as in automobiles or automobile trunks.

Soft body armor should be cared for and cleaned pursuant to the manufacturer's care instructions provided with the soft body armor. The instructions can be found on labels located on the external surface of each ballistic panel. The carrier should also have a label that contains care instructions. Failure to follow these instructions may damage the ballistic performance capabilities of the armor. If care instructions for the soft body armor cannot be located, contact the manufacturer to request care instructions.

Soft body armor should not be exposed to any cleaning agents or methods not specifically recommended by the manufacturer, as noted on the armor panel label.

Soft body armor should be replaced in accordance with the manufacturer's recommended replacement schedule.

1010.4 RANGEMASTER RESPONSIBILITIES

The Rangemaster should:

- (a) Monitor technological advances in the body armor industry for any appropriate changes to Department approved body armor.
- (b) Assess weapons and ammunition currently in use and the suitability of approved body armor to protect against those threats.
- (c) Provide training that educates officers about the safety benefits of wearing body armor.

Personnel Records

1011.1 PURPOSE AND SCOPE

This policy governs maintenance and access to personnel records. Personnel records include any file maintained under an individual member's name.

1011.2 POLICY

It is the policy of this department to maintain personnel records and preserve the confidentiality of personnel records pursuant to the Constitution and the laws of California (Penal Code § 832.7).

1011.3 DEPARTMENT FILE

The department file shall be maintained as a record of a person's employment/appointment with this department. The department file should contain, at a minimum:

- (a) Personal data, including photographs, marital status, names of family members, educational and employment history, or similar information. A photograph of the member should be permanently retained.
- (b) Election of employee benefits.
- (c) Personnel action reports reflecting assignments, promotions, and other changes in employment/appointment status. These should be permanently retained.
- (d) Original performance evaluations. These should be permanently retained.
- (e) Discipline records, including copies of sustained personnel complaints (see the Personnel Complaints Policy).
 - 1. Disciplinary action resulting from sustained internally initiated complaints or observation of misconduct shall be maintained pursuant to the established records retention schedule and at least four years (Government Code § 12946).
 - 2. Disciplinary action resulting from a sustained civilian's complaint involving misconduct shall be maintained pursuant to the established records retention schedule and at least 15 years (Penal Code § 832.5).
 - 3. A civilian's complaint involving misconduct that was not sustained shall be maintained pursuant to the established records retention schedule and at least five years (Penal Code § 832.5).
- (f) Adverse comments such as supervisor notes or memos may be retained in the department file after the member has had the opportunity to read and initial the comment (Government Code § 3305).
 - 1. Once a member has had an opportunity to read and initial any adverse comment, the member shall be given the opportunity to respond in writing to the adverse comment within 30 days (Government Code § 3306).
 - 2. Any member response shall be attached to and retained with the original adverse comment (Government Code § 3306).

Culver City Police Department

Culver City PD Policy Manual

Personnel Records

3. If a member refuses to initial or sign an adverse comment, at least one supervisor should note the date and time of such refusal on the original comment and the member should sign or initial the noted refusal. Such a refusal, however, shall not be deemed insubordination, nor shall it prohibit the entry of the adverse comment into the member's file (Government Code § 3305).
- (g) Commendations and awards.
 - (h) Any other information, the disclosure of which would constitute an unwarranted invasion of personal privacy.

1011.4 BUREAU FILE

Bureau files may be separately maintained internally by a member's supervisor for the purpose of completing timely performance evaluations. The Bureau file may contain supervisor comments, notes, notices to correct and other materials that are intended to serve as a foundation for the completion of timely performance evaluations.

All materials intended for this interim file shall be provided to the employee prior to being placed in the file in accordance with Government Code § 3305 and Government Code § 3306.

1011.5 TRAINING FILE

An individual training file shall be maintained by the Personnel and Training Lieutenant for each member. Training files will contain records of all training; original or photocopies of available certificates, transcripts, diplomas and other documentation; and education and firearms qualifications. Training records may also be created and stored remotely, either manually or automatically (e.g., Daily Training Bulletin (DTB) records).

- (a) The involved member is responsible for providing the Personnel and Training Lieutenant or immediate supervisor with evidence of completed training/education in a timely manner.
- (b) The Personnel and Training Lieutenant or supervisor shall ensure that copies of such training records are placed in the member's training file.

1011.6 INTERNAL AFFAIRS FILE

Internal affairs files shall be maintained under the exclusive control of the Professional Standards Unit in conjunction with the office of the Chief of Police. Access to these files may only be approved by the Chief of Police or the Professional Standards Unit supervisor.

These files shall contain the complete investigation of all formal complaints of member misconduct, regardless of disposition (Penal Code § 832.12). Investigations of complaints that result in the following findings shall not be placed in the member's file but will be maintained in the internal affairs file:

- (a) Not sustained
- (b) Unfounded
- (c) Exonerated

Culver City Police Department

Culver City PD Policy Manual

Personnel Records

Investigation files arising out of sustained civilian's complaints involving misconduct shall be maintained pursuant to the established records retention schedule and for a period of at least 15 years. Investigations that resulted in other than a sustained finding may not be used by the Department to adversely affect an employee's career (Penal Code § 832.5).

Investigation files arising out of internally generated complaints shall be maintained pursuant to the established records retention schedule and for at least four years (Government Code § 12946).

Investigation files arising out of a civilian complaint involving misconduct that was not sustained shall be maintained pursuant to the established records retention schedule and for at least five years (Penal Code § 832.5).

1011.7 MEDICAL FILE

A medical file shall be maintained separately from all other personnel records and shall contain all documents relating to the member's medical condition and history, including but not limited to:

- (a) Materials relating to a medical leave of absence, including leave under the Family and Medical Leave Act (FMLA).
- (b) Documents relating to workers' compensation claims or the receipt of short- or long-term disability benefits.
- (c) Fitness-for-duty examinations, psychological and physical examinations, follow-up inquiries and related documents.
- (d) Medical release forms, doctor's slips and attendance records that reveal a member's medical condition.
- (e) Any other documents or materials that reveal the member's medical history or medical condition, including past, present or future anticipated mental, psychological or physical limitations.

1011.8 SECURITY

Personnel records should be maintained in a secured location and locked either in a cabinet or access-controlled room. Personnel records maintained in an electronic format should have adequate password protection.

Personnel records are subject to disclosure only as provided in this policy, the Records Maintenance and Release Policy or according to applicable discovery procedures.

Nothing in this policy is intended to preclude review of personnel records by the City Council, City Attorney or other attorneys or representatives of the City in connection with official business.

1011.8.1 REQUESTS FOR DISCLOSURE

Any member receiving a request for a personnel record shall promptly notify the Custodian of Records or other person charged with the maintenance of such records.

Upon receipt of any such request, the responsible person shall notify the affected member as soon as practicable that such a request has been made (Evidence Code § 1043).

Culver City Police Department

Culver City PD Policy Manual

Personnel Records

The responsible person shall further ensure that an appropriate response to the request is made in a timely manner, consistent with applicable law. In many cases, this may require assistance of available legal counsel.

All requests for disclosure that result in access to a member's personnel records shall be logged in the corresponding file.

1011.8.2 RELEASE OF PERSONNEL INFORMATION

Personnel records shall not be disclosed except as allowed by law (Penal Code § 832.7; Evidence Code § 1043) (see also Records Maintenance and Release Policy).

Any person who maliciously, and with the intent to obstruct justice or the due administration of the laws, publishes, disseminates, or otherwise discloses the residence address or telephone number of any member of this department may be guilty of a misdemeanor (Penal Code § 146e).

The Department may release any factual information concerning a disciplinary investigation if the member who is the subject of the investigation (or the member's representative) publicly makes a statement that is published in the media and that the member (or representative) knows to be false. The disclosure of such information, if any, shall be limited to facts that refute any such false statement (Penal Code § 832.7).

The Department may, without a request, disclose to the public the cause of termination for a disclosable incident involving a former officer, as permitted by law (Penal Code § 832.7(b)(13)).

1011.8.3 RELEASE OF LAW ENFORCEMENT GANG INFORMATION

Information relating to the termination of an officer from this department for participation in a law enforcement gang shall be disclosed to another law enforcement agency that is conducting a pre-employment background investigation except where specifically prohibited by law (Penal Code § 13670).

1011.8.4 RELEASE OF PEACE OFFICER RECORDS RELATING TO HATE COMPLAINTS

Records relating to an officer for an investigation of a hate complaint described in Penal Code § 13682 with a sustained finding that the officer engaged in membership in a hate group, participated in a hate group activity, or advocacy of public expressions of hate are not confidential and shall be made available for public inspection through a public records request (Penal Code § 13683).

Records disclosed may be redacted as provided in Penal Code § 13683.

1011.9 MEMBERS' ACCESS TO THEIR PERSONNEL RECORDS

Any member may request access to the member's own personnel records during the normal business hours of those responsible for maintaining such files. Any member seeking the removal of any item from the member's personnel records shall file a written request to the Chief of Police through the chain of command. The Department shall remove any such item if appropriate, or within 30 days provide the member with a written explanation of why the contested item will not be removed. If the contested item is not removed from the file, the member's request and the

Culver City Police Department

Culver City PD Policy Manual

Personnel Records

written response from the Department shall be retained with the contested item in the member's corresponding personnel record (Government Code § 3306.5).

Members may be restricted from accessing files containing any of the following information:

- (a) An ongoing internal affairs investigation to the extent that it could jeopardize or compromise the investigation pending final disposition or notice to the member of the intent to discipline.
- (b) Confidential portions of internal affairs files that have not been sustained against the member.
- (c) Criminal investigations involving the member.
- (d) Letters of reference concerning employment/appointment, licensing, or issuance of permits regarding the member.
- (e) Any portion of a test document, except the cumulative total test score for either a section of the test document or for the entire test document.
- (f) Materials used by the Department for staff management planning, including judgments or recommendations concerning future salary increases and other wage treatments, management bonus plans, promotions and job assignments, or other comments or ratings used for department planning purposes.
- (g) Information of a personal nature about a person other than the member if disclosure of the information would constitute a clearly unwarranted invasion of the other person's privacy.
- (h) Records relevant to any other pending claim between the Department and the member that may be discovered in a judicial proceeding.

1011.10 RETENTION AND PURGING

Unless provided otherwise in this policy, personnel records shall be maintained in accordance with the established records retention schedule.

- (a) During the preparation of each member's performance evaluation, all personnel complaints and disciplinary actions should be reviewed to determine the relevancy, if any, to progressive discipline, training and career development. Each supervisor responsible for completing the member's performance evaluation should determine whether any prior sustained disciplinary file should be retained beyond the required period for reasons other than pending litigation or other ongoing legal proceedings.
- (b) If a supervisor determines that records of prior discipline should be retained beyond the required period, approval for such retention should be obtained through the chain of command from the Chief of Police.
- (c) If, in the opinion of the Chief of Police, a personnel complaint or disciplinary action maintained beyond the required retention period is no longer relevant, all records of such matter may be destroyed in accordance with the established records retention schedule.

Culver City Police Department

Culver City PD Policy Manual

Personnel Records

1011.11 RELEASE OF PERSONNEL RECORDS AND RECORDS RELATED TO CERTAIN INCIDENTS, COMPLAINTS, AND INVESTIGATIONS OF OFFICERS

Personnel records and records related to certain incidents, complaints, and investigations of officers shall be released pursuant to a proper request under the Public Records Act and subject to redaction and delayed release as provided by law.

The Custodian of Records should work as appropriate with the Chief of Police or the Professional Standards Unit supervisor in determining what records may qualify for disclosure when a request for records is received and if the requested record is subject to redaction or delay from disclosure.

For purposes of this section, a record includes (Penal Code § 832.7(b)(3):

- All investigation reports.
- Photographic, audio, and video evidence.
- Transcripts or recordings of interviews.
- Autopsy reports.
- All materials compiled and presented for review to the District Attorney or to any person or body charged with determining whether to file criminal charges against an officer in connection with an incident, whether the officer's action was consistent with law and department policy for purposes of discipline or administrative action, or what discipline to impose or corrective action to take.
- Documents setting forth findings or recommending findings.
- Copies of disciplinary records relating to the incident, including any letters of intent to impose discipline, any documents reflecting modifications of discipline due to the *Skelly* or grievance process, and letters indicating final imposition of discipline or other documentation reflecting implementation of corrective action.

Unless a record or information is confidential or qualifies for delayed disclosure as provided by Penal Code § 832.7(b)(8) or other law, the following records (hereinafter qualifying records) shall be made available for public inspection no later than 45 days from the date of a request (Penal Code § 832.7(b)(1)):

- (a) Records relating to the report, investigation, or findings of:
 1. The discharge of a firearm at another person by an officer.
 2. The use of force against a person resulting in death or in great bodily injury (as defined by Penal Code § 243(f)(4)) by an officer.
 3. A sustained finding involving a complaint that alleges unreasonable or excessive force.
 4. A sustained finding that an officer failed to intervene against another officer using force that is clearly unreasonable or excessive.
- (b) Records relating to an incident where a sustained finding was made by the Department or oversight agency regarding:

Culver City Police Department

Culver City PD Policy Manual

Personnel Records

1. An officer engaged in sexual assault of a member of the public (as defined by Penal Code § 832.7(b)).
2. Dishonesty of an officer relating to the reporting, investigation, or prosecution of a crime, or directly relating to the reporting of, or investigation of misconduct by, another officer, including but not limited to any false statements, filing false reports, destruction, falsifying, or concealing of evidence, or perjury.
3. An officer engaged in conduct including but not limited to verbal statements, writings, online posts, recordings, and gestures involving prejudice or discrimination against a person on the basis of race, religious creed, color, national origin, ancestry, physical disability, mental disability, medical condition, genetic information, marital status, sex, gender, gender identity, gender expression, age, sexual orientation, or military and veteran status.
4. An officer made an unlawful arrest or conducted an unlawful search.

Qualifying records will be made available regardless of whether the officer resigns before the Department or an oversight agency concludes its investigation (Penal Code § 832.7(b)(3)).

A record from a separate and prior investigation or assessment of a separate incident shall not be released unless it is independently subject to disclosure (Penal Code § 832.7(b)(4)).

When an investigation involves multiple officers, the Department shall not release information about allegations of misconduct or the analysis or disposition of an investigation of an officer unless it relates to a sustained finding of a qualified allegation as provided by Penal Code § 832.7(b)(5). However, factual information about the action of the officer during an incident or the statements of an officer shall be released if the statements are relevant to a finding of the qualified allegation against another officer that is subject to release (Penal Code § 832.7(b)(5)).

1011.11.1 REDACTION

The Custodian of Records, in consultation with the Chief of Police or authorized designee, shall redact the following portions of qualifying records made available for release (Penal Code § 832.7(b)(6)):

- (a) Personal data or information (e.g., home address, telephone number, identities of family members) other than the names and work-related information of officers
- (b) Information that would compromise the anonymity of whistleblowers, complainants, victims, and witnesses
- (c) Confidential medical, financial, or other information where disclosure is prohibited by federal law or would cause an unwarranted invasion of personal privacy that clearly outweighs the strong public interest in records about possible misconduct and use of force
- (d) Where there is a specific, articulable, and particularized reason to believe that disclosure of the record would pose a significant danger to the physical safety of the officer or another person

Culver City Police Department

Culver City PD Policy Manual

Personnel Records

Additionally, a record may be redacted, including redacting personal identifying information, where, on the facts of the particular case, the public interest served by not disclosing the information clearly outweighs the public interest served by disclosing it (Penal Code § 832.7(b)(7)).

1011.11.2 DELAY OF RELEASE

Unless otherwise directed by the Chief of Police, the Custodian of Records should consult with a supervisor familiar with the underlying investigation to determine whether to delay disclosure of qualifying records due to any of the following conditions (Penal Code § 832.7):

- (a) Active criminal investigations
 - 1. Disclosure may be delayed 60 days from the date the misconduct or use of force occurred or until the District Attorney determines whether to file criminal charges, whichever occurs sooner.
 - 2. After the initial 60 days, delay of disclosure may be continued if the disclosure could reasonably be expected to interfere with a criminal enforcement proceeding against an officer or against someone other than an officer who engaged in misconduct or used the force.
- (b) Filed criminal charges
 - 1. When charges are filed related to an incident in which misconduct occurred or force was used, disclosure may be delayed until a verdict on those charges is returned at trial or, if a plea of guilty or no contest is entered, the time to withdraw the plea has passed.
- (c) Administrative investigations
 - 1. Disclosure may be delayed until:
 - (a) There is a determination from the investigation whether the misconduct or use of force violated law or department policy, but no longer than 180 days after the date of the department's discovery of the misconduct or use of force or allegation of misconduct or use of force

1011.11.3 NOTICE OF DELAY OF RECORDS

When there is justification for delay of disclosure of qualifying records, the Custodian of Records shall provide written notice of the reason for any delay to a requester as follows (Penal Code § 832.7):

- (a) Provide the specific basis for the determination that the interest in delaying disclosure clearly outweighs the public interest in disclosure. The notice shall also include the estimated date for the disclosure of the withheld information.
- (b) When delay is continued beyond the initial 60 days because of criminal enforcement proceedings against anyone, at 180-day intervals provide the specific basis that disclosure could reasonably be expected to interfere with a criminal enforcement proceeding and the estimated date for disclosure.
 - 1. Information withheld shall be disclosed when the specific basis for withholding the information is resolved, the investigation or proceeding is no longer active, or

Culver City Police Department

Culver City PD Policy Manual

Personnel Records

no later than 18 months after the date of the incident, whichever occurs sooner, unless:

- (a) When the criminal proceeding is against someone other than an officer and there are extraordinary circumstances to warrant a continued delay due to the ongoing criminal investigation or proceeding, then the Department must show by clear and convincing evidence that the interest in preventing prejudice to the active and ongoing criminal investigation or proceeding outweighs the public interest for prompt disclosure of records about misconduct or use of force by officers.

In cases where an action to compel disclosure is brought pursuant to Government Code § 7923.000, the Department may justify delay by filing an application to seal the basis for withholding if disclosure of the written basis itself would impact a privilege or compromise a pending investigation (Penal Code § 832.7(b)(8)).

Request for Change of Assignment

1012.1 PURPOSE AND SCOPE

It is the intent of the Department that all requests for change of assignment are considered equally. To facilitate the selection process, the following procedure is established whereby all such requests will be reviewed on an equal basis as assignments are made.

1012.2 REQUEST FOR CHANGE OF ASSIGNMENT

Personnel wishing a change of assignment are to complete a memorandum expressing this. The memorandum should then be forwarded through the chain of command to their Bureau Commander.

1012.2.1 PURPOSE OF MEMORANDUM

The memorandum is designed to aid employees in listing their qualifications for specific assignments. All relevant experience, education and training may be included when completing this memorandum.

The Request for Change of Assignment memorandum may remain in effect until the end of the calendar year in which it was submitted.

1012.3 SUPERVISOR'S COMMENTARY

The officer's immediate supervisor may make appropriate comments on the memorandum before forwarding it to the Bureau Commander of the employee involved. In the case of patrol officers, the Watch Commander may comment on the memorandum with his/her recommendation before forwarding the request to the Bureau Commander.

1012.4 SPECIAL ASSIGNMENT SELECTION

In addition to the request for change of assignment process detailed above, selection to the following specialized and/or collateral assignments will also require successful participation in a structured interview to be conducted by respective unit supervisors:

- Senior Lead Detectives
- Canine Handler (K9)
- Emergency Response Team (ERT)
- Crisis Negotiation Team (CNT)
- Regional Task Force Detective
- Field Training Officer (FTO)
- Mental Health Evaluation Team

Commendations and Awards

1013.1 PURPOSE AND SCOPE

This policy provides general guidelines for recognizing commendable or meritorious acts of members of the Culver City Police Department and individuals from the community.

1013.2 POLICY

It is the policy of the Culver City Police Department to recognize and acknowledge exceptional individual or group achievements, performance, proficiency, heroism and service of its members and individuals from the community through commendations and awards.

1013.3 COMMENDATIONS

Commendations for members of the Department or for individuals from the community may be initiated by any department member or by any person from the community.

1013.4 CRITERIA

A meritorious or commendable act may include, but is not limited to:

- Superior handling of a difficult situation.
- Conspicuous bravery or outstanding performance.
- Any action or performance that is above and beyond typical duties.

1013.4.1 DEPARTMENT MEMBER DOCUMENTATION

Members of the Department should document meritorious or commendable acts. The documentation should contain:

- (a) Identifying information:
 1. For members of the Department - name, bureau and assignment at the date and time of the meritorious or commendable act
 2. For individuals from the community - name, address, telephone number
- (b) A brief account of the meritorious or commendable act with report numbers, as appropriate.
- (c) The signature of the member submitting the documentation.

1013.4.2 COMMUNITY MEMBER DOCUMENTATION

Documentation of a meritorious or commendable act submitted by a person from the community should be accepted in any form. However, written documentation is preferred. Department members accepting the documentation should attempt to obtain detailed information regarding the matter, including:

- (a) Identifying information:
 1. For members of the Department - name, bureau and assignment at the date and time of the meritorious or commendable act

Culver City Police Department

Culver City PD Policy Manual

Commendations and Awards

2. For individuals from the community - name, address, telephone number
 - (b) A brief account of the meritorious or commendable act with report numbers, as appropriate.
 - (c) The signature of the person submitting the documentation.

1013.5 AWARDS

Awards may be bestowed upon members of the Department and individuals from the community.

These awards include:

- Medal of Valor
- Distinguished Service Medal
- Sustained Superiority Award
- Special Recognition Award
- Lifesaving Award.

Criteria for each award and the selection, presentation and display of any award are determined by the Chief of Police or his/her designee.

Fitness for Duty

1014.1 PURPOSE AND SCOPE

All officers are required to be free from any physical, emotional, or mental condition which might adversely affect the exercise of peace officer powers. The purpose of this policy is to ensure that all officers of this department remain fit for duty and able to perform their job functions (Government Code § 1031).

1014.2 EMPLOYEE RESPONSIBILITIES

- (a) It shall be the responsibility of each member of this department to maintain good physical condition sufficient to safely and properly perform essential duties of their position.
- (b) Each member of this department shall perform his/her respective duties without physical, emotional, and/or mental constraints.
- (c) During working hours, all employees are required to be alert, attentive, and capable of performing his/her assigned responsibilities.
- (d) Any employee who feels unable to perform his/her duties shall promptly notify a supervisor. In the event that an employee believes that another employee is unable to perform his/her duties, such observations and/or belief shall be promptly reported to a supervisor.

1014.3 SUPERVISOR RESPONSIBILITIES

- (a) A supervisor observing an employee, or receiving a report of an employee who is perceived to be, unable to safely perform his/her duties due to a physical or mental condition shall take prompt and appropriate action in an effort to resolve the situation.
- (b) Whenever feasible, the supervisor should attempt to ascertain the reason or source of the problem and in all cases a preliminary evaluation should be made in an effort to determine the level of inability of the employee to perform his/her duties.
- (c) In the event the employee appears to be in need of immediate medical or psychiatric treatment, all reasonable efforts should be made to provide such care.
- (d) In conjunction with the Watch Commander or employee's available Bureau Commander, a determination should be made whether or not the employee should be temporarily relieved from his/her duties.
- (e) The Chief of Police and the appropriate chain of command shall be promptly notified in the event that any employee is relieved from duty.

1014.4 NON-WORK RELATED CONDITIONS

Any employee suffering from a non-work related condition which warrants a temporary relief from duty may be required to use sick leave or other paid time off (PTO) in order to obtain medical treatment or other reasonable rest period.

Culver City Police Department

Culver City PD Policy Manual

Fitness for Duty

1014.5 WORK RELATED CONDITIONS

Any employee suffering from a work related condition which warrants a temporary relief from duty shall be required to comply with personnel rules and guidelines for processing such claims.

Upon the recommendation of the Watch Commander or unit supervisor and concurrence of a Bureau Commander, any employee whose actions or use of force in an official capacity result in death or serious injury to another may be temporarily removed from regularly assigned duties and/or placed on paid administrative leave for the wellbeing of the employee and until such time as the following may be completed:

- (a) A preliminary determination that the employee's conduct appears to be in compliance with policy and, if appropriate.
- (b) The employee has had the opportunity to receive necessary counseling and/or psychological clearance to return to full duty.

1014.6 PHYSICAL AND PSYCHOLOGICAL EXAMINATIONS

- (a) Whenever circumstances reasonably indicate that an employee is unfit for duty, the Chief of Police may serve that employee with a written order to undergo a physical and/or psychological examination in cooperation with Personnel and Training to determine the level of the employee's fitness for duty. The order shall indicate the date, time and place for the examination.
- (b) The examining physician or therapist will provide the Department with a report indicating that the employee is either fit for duty or, if not, listing any functional limitations which limit the employee's ability to perform job duties. If the employee places his/her condition at issue in any subsequent or related administrative action/grievance, the examining physician or therapist may be required to disclose any and all information which is relevant to such proceeding (Civil Code § 56.10(c)(8)).
- (c) In order to facilitate the examination of any employee, the Department will provide all appropriate documents and available information to assist in the evaluation and/or treatment.
- (d) All reports and evaluations submitted by the treating physician or therapist shall be part of the employee's confidential personnel file.
- (e) Any employee ordered to receive a fitness for duty examination shall comply with the terms of the order and cooperate fully with the examining physician or therapist regarding any clinical interview, tests administered or other procedures as directed. Any failure to comply with such an order and any failure to cooperate with the examining physician or therapist may be deemed insubordination and shall be subject to discipline up to and including termination.
- (f) Once an employee has been deemed fit for duty by the examining physician or therapist, the employee will be notified to resume his/her duties.

Culver City Police Department

Culver City PD Policy Manual

Fitness for Duty

1014.7 LIMITATION ON HOURS WORKED

Absent emergency operations members should not work more than:

- 16 hours in one day (24 hour) period or
- 30 hours in any 2 day (48 hour) period or
- 84 hours in any 7 day (168 hour) period

Except in very limited circumstances members should have a minimum of 8 hours off between shifts. Supervisors should give consideration to reasonable rest periods and are authorized to deny overtime or relieve to off-duty status any member who has exceeded the above guidelines.

Limitations on the number of hours worked apply to shift changes, shift trades, rotation, holdover, training, general overtime and any other work assignments.

1014.8 APPEALS

An employee who is separated from paid employment or receives a reduction in salary resulting from a fitness for duty examination shall be entitled to an administrative appeal as outlined in the Personnel Complaints Policy.

Meal Periods and Breaks

1015.1 PURPOSE AND SCOPE

This policy regarding meals and breaks, insofar as possible shall conform to the policy governing all City employees established by their respective MOUs.

1015.1.1 MEAL PERIODS

Sworn employees and dispatchers shall remain on duty subject to call during meal breaks. All other employees are not on call during meal breaks unless directed otherwise by a supervisor.

Uniformed patrol and traffic officers shall request clearance from the Communications Center prior to taking a meal period. Uniformed officers should take their breaks within the City limits unless on assignment outside of the City.

The time spent for the meal period shall not exceed the authorized time allowed.

1015.1.2 15 MINUTE BREAKS

Each employee is entitled to a 15 minute break, near the mid point, for each four-hour work period. Only one 15 minute break shall be taken during each four hours of duty. No breaks shall be taken during the first or last hour of an employee's shift unless approved by a supervisor.

Employees normally assigned to the police facility shall remain at the police facility for their breaks. This would not prohibit them from taking a break outside the facility if on official business.

Field officers will take their breaks in their assigned areas, subject to call and shall monitor their radios. When field officers take their breaks away from their vehicles, they shall do so only with the knowledge and clearance of the Communications Center.

Lactation Breaks

1016.1 PURPOSE AND SCOPE

The purpose of this policy is to provide guidance regarding reasonable accommodations for lactating members (Labor Code § 1034).

1016.2 POLICY

It is the policy of the Culver City Police Department to provide, in compliance with federal and state law, reasonable accommodations for lactating members. This includes break time and appropriate facilities to accommodate any member desiring to express breast milk for the member's nursing child (29 USC § 218d; 42 USC § 2000gg-1; 29 CFR 1636.3; Labor Code § 1030).

1016.3 LACTATION BREAK TIME

A rest period should be permitted each time the member requires a lactation break (29 USC § 218d; 42 USC § 2000gg-1; 29 CFR 1636.3; Labor Code § 1030). In general, lactation breaks that cumulatively total 30 minutes or less during any four-hour work period or major portion of a four-hour work period would be considered reasonable. However, individual circumstances may require more or less time.

Lactation breaks, if feasible, should be taken at the same time as the member's regularly scheduled rest or meal periods. While a reasonable effort will be made to provide additional time beyond authorized breaks, any such time exceeding regularly scheduled and paid break time will be unpaid (Labor Code § 1030).

Members desiring to take a lactation break shall notify the dispatcher or a supervisor prior to taking such a break. Such breaks may be reasonably delayed if they would seriously disrupt department operations (Labor Code § 1032).

Once a lactation break has been approved, the break should not be interrupted except for emergency or exigent circumstances.

1016.4 PRIVATE LOCATION

The Department will make reasonable efforts to accommodate members with the use of an appropriate room or other location to express milk in private. Such room or place should be in proximity to the member's work area and shall be other than a bathroom or toilet stall. The location must be shielded from view, free from intrusion from coworkers and the public, and otherwise satisfy the requirements of federal and state law (29 USC § 218d; 42 USC § 2000gg-1; 29 CFR 1636.3; Labor Code § 1031).

Members occupying such private areas shall either secure the door or otherwise make it clear to others that the area is occupied with a need for privacy. All other members should avoid interrupting a member during an authorized break, except to announce an emergency or other urgent circumstance.

Culver City Police Department

Culver City PD Policy Manual

Lactation Breaks

Authorized lactation breaks for members assigned to the field may be taken at the nearest appropriate private area.

1016.5 STORAGE OF EXPRESSED MILK

Any member storing expressed milk in any authorized refrigerated area within the Department shall clearly label it as such and shall remove it when the member's shift ends.

1016.5.1 STATE REQUIREMENTS

Members have the right to request lactation accommodations. If a break time or location accommodation cannot be provided, the supervisor shall provide the member with a written response regarding the reasons for the determination (Labor Code § 1034).

Lactation rooms or other locations should comply with the prescribed feature and access requirements of Labor Code § 1031.

Members who believe that their rights have been violated under this policy or have been the subject of discrimination or retaliation for exercising or attempting to exercise their rights under this policy, are encouraged to follow the chain of command in reporting a violation, but may also file a complaint directly with the Labor Commissioner (Labor Code § 1033).

Payroll Records

1017.1 PURPOSE AND SCOPE

This policy provides the guidelines for completing and submitting payroll records of department members who are eligible for the payment of wages.

1017.2 RESPONSIBILITIES

Members are responsible for the accurate completion and timely approval of their payroll records for the payment of wages.

Supervisors are responsible for approving the payroll records for those under their commands.

The Office of the Chief's Secretary is responsible for maintaining the administrative role for Department online payroll system, currently Executime.

1017.3 TIME REQUIREMENTS

Members who are eligible for the payment of wages are paid on a scheduled, periodic basis, generally on the same day or date each period, with certain exceptions, such as holidays. Payroll records shall be completed and submitted to the Office of the Chief as established by the City payroll procedures.

1017.4 POLICY

The Culver City Police Department maintains timely and accurate payroll records.

1017.5 RECORDS

The Administration Bureau Bureau Commander shall ensure that accurate and timely payroll records are maintained as required by 29 CFR 516.2 for a minimum of three years (29 CFR 516.5).

Overtime Compensation Requests

1018.1 PURPOSE AND SCOPE

It is the policy of the Department to compensate non-exempt salaried employees who work authorized overtime either by payment of wages as agreed and in effect through the Memorandum of Understanding (MOU), or by the allowance of accrual of compensatory time off. In order to qualify for either, the employee must complete and submit a Request for Overtime Payment as soon as practical after overtime is worked.

Currently, the method by which Requests for Overtime Payments are made is electronically through the Department's "Executime" payroll system.

1018.1.1 DEPARTMENT POLICY

Because of the nature of police work, and the specific needs of the Department, a degree of flexibility concerning overtime policies must be maintained.

Non-exempt employees are not authorized to volunteer work time to the Department. All requests to work overtime shall be approved in advance by a supervisor. If circumstances do not permit prior approval, then approval shall be sought as soon as practical during the overtime shift and in no case later than the end of shift in which the overtime is worked.

Short periods of work at the end of the normal duty day (e.g., less than one hour in duration) may be handled unofficially between the supervisor and the employee by flexing a subsequent shift schedule to compensate for the time worked rather than by submitting requests for overtime payments. If the supervisor authorizes or directs the employee to complete an Executime entry for such a period, the employee shall comply.

The individual employee may request compensatory time in lieu of receiving overtime payment, however, the employee may not exceed 300 hours of compensatory time.

1018.2 REQUEST FOR OVERTIME COMPENSATION

Employees shall submit all overtime compensation requests to their immediate supervisors as soon as practicable for verification.

Failure to submit a request for overtime compensation in a timely manner may result in discipline.

1018.2.1 EMPLOYEES RESPONSIBILITY

Employees shall complete the requests immediately after working the overtime and advise their immediate supervisor or the Watch Commander for approval. Employees submitting overtime requests for on-call pay when off duty shall complete an Executime entry the first day after returning for work.

1018.2.2 SUPERVISORS RESPONSIBILITY

The supervisor who verifies the overtime earned shall verify that the overtime was worked before approving the request.

Culver City Police Department

Culver City PD Policy Manual

Overtime Compensation Requests

1018.3 ACCOUNTING FOR OVERTIME WORKED

Employees are to record the actual time worked in an overtime status. In some cases, the Memorandum of Understanding provides that a minimum number of hours will be paid, (e.g., four hours for Court, four hours for outside overtime). The supervisor will enter the actual time worked.

1018.3.1 ACCOUNTING FOR PORTIONS OF AN HOUR

When accounting for less than a full hour, time worked shall be rounded up to the nearest quarter of an hour as indicated by the following chart:

<u>TIME WORKED</u>	<u>INDICATE IN EXECUTIME</u>
1 to 15 minutes	.25
16 to 30 minutes	.50
31 to 45 minutes	.75
46 to 60 minutes	1 hour

1018.3.2 VARIATION IN TIME REPORTED

Where two or more employees are assigned to the same activity, case, or court trial and the amount of time for which payment is requested varies from that reported by the other officer, the Watch Commander or other approving supervisor may require each employee to include the reason for the variation in the "explanation" section of the Executime request.

1018.4 PAY ROLL PROCEDURES

- (a) Executime entries are submitted to their respective supervisors and chain of command on a biweekly basis for the payment of wages.
- (b) Employees' supervisors are responsible for the accurate and timely submission of time cards for the payment of wages.
- (c) All employees are paid on a biweekly basis, usually on Friday, with certain exceptions such as holidays. Executime entries shall be completed and submitted no later than 8:00 a.m. on the Monday morning after the end of the pay period unless specified otherwise.

1018.5 LEAVE OF ABSENCE

1018.5.1 VACATION LEAVE

Employees shall be eligible for vacation in accordance with the terms and provisions of their MOU. The appointing authority shall provide for an annual leave schedule in order to provide each employee with an opportunity to take his full vacation each year.

1018.5.2 FORMS AND PROCEDURE

Whenever possible, employees shall file an Executime request for a leave of absence before taking such leave. Where conditions prevent prior request, the employee, upon returning from said leave, shall file a report explaining the conditions which prevented a prior request. Failure to file a prior request, in the absence of extenuating conditions, shall be grounds for disciplinary action.

Culver City Police Department

Culver City PD Policy Manual

Overtime Compensation Requests

1018.5.3 LEAVE OF ABSENCE: OTHER

It shall be the policy of the City Government to grant leaves of absence to permanent and probationary employees for the purpose of rest and relaxation and for recuperation from illness based on each employee's total length of service with the City. Employees are expected to take advantage of the vacation provisions afforded them by this rule, in order to maintain their mental and physical health.

The various types of leave for each category of employees are covered in the appropriate MOU. These include:

- (a) Bereavement Leave
- (b) Emergency Leave
- (c) Military Leave
- (d) Voting Leave
- (e) Jury Duty
- (f) Award Leave/Merit Leave
- (g) Advance Leave
- (h) Leave Without Pay

1018.5.4 JURY DUTY: POLICY & PROCEDURES

Jury duty paid leave covers the actual time of jury service and the travel time to and from the point of service. The employee shall be compensated as if he worked the regular shift for that day. He shall not be entitled to any overtime, beyond the number of hours during a regular work shift, caused by the court. The employee shall return to the City any compensation received from the court for such service, exclusive of mileage.

Employees who are not required to serve a full day of jury service shall report to work for the balance of their normal work shift if the release time allows at least 2 hours of work in addition to travel time.

When an employee's work assignment is such that jury service will significantly impair City services, the City may provide the employee with a written request for exemption or postponement from jury service. The employee shall present this request to the Jury Supervisor and notify his City Supervisor of the outcome.

Employees scheduled for evening or weekend shifts, may be temporarily reassigned to weekday, or day watch hours to accommodate the jury service period. If the employee desires, and with supervisory approval, the employee may work his normal schedule and attend jury duty during off duty hours. In such cases, the employee shall retain all jury service compensation from the court for all off duty time spent on jury duty.

In order to be compensated for jury services, the employee shall provide to his supervisor, upon his return to work, a validation of jury service. The validation shall be a properly stamped statement from the court noting the dates and times of attendance.

Culver City Police Department

Culver City PD Policy Manual

Overtime Compensation Requests

Failure by an employee to provide proper validation of his jury service time immediately upon return from such service, or the failure to reimburse the City upon receipt of jury pay from the court, shall invalidate the employee's eligibility for City compensation for the period of leave. Disciplinary and civil actions may be taken to recover payments for jury duty leave.

When an employee is first notified of a subpoena for jury duty, he shall immediately notify his immediate supervisor of the date, and time service is expected to commence. The supervisor shall determine if a request for exemption or consecutive days is needed and shall prepare such documentation for the employee.

If a postponement is desirable, the supervisor shall instruct the employee to contact the Jury Supervisor's office to request it. It is the employee's immediate supervisor's responsibility to instruct the employee on the procedure to validate service and qualify for City compensation. The supervisor shall be responsible for verification of the employee's jury duty.

Upon completion of jury duty, the employee shall:

- (a) Provide his supervisor with the proper validation of jury service time.
- (b) Reimburse the City for jury duty pay received from the court, less mileage, within 10 working days of receipt of the check from the court.

The supervisor should send a copy of the jury service validation to the City Clerk's office, through Department channels, immediately upon receipt. When the employee receives his check from the court, he shall notify his immediate supervisor and issue a payment to the City for the per diem rate times the number of days served. This payment shall be provided within ten working days to the City Treasurer through the employee's supervisor.

If the employee fails to comply with the requirements for time validation or reimbursement, the Chief of Police shall notify the employee of his intention to discipline for such violation of this policy. Additionally, the City has the option by civil action or other means available of recovering monies owed.

1018.5.5 LEAVE OF ABSENCE REQUEST PROCEDURE

An employee wishing to take a leave shall submit an Executime Leave of Absence Request to their immediate supervisor for approval prior to taking any time off, except in an emergency. Requests which are denied shall be returned to the employee with an explanation of the reason for denial. Approved requests shall be forwarded to the Executime Administer.

The Executime Leave of Absence Request shall be utilized by all employees for all types of leave.

Employees are to use the "Explanation" block to report non-service connected injuries, as well as explanations for various types of leave when appropriate. (i.e. "Bereavement Leave/death of grandmother.") Also, indicate the type of leave under "Other" where appropriate. (i.e. jury duty, merit leave, military leave, etc.).

Outside Employment

1019.1 PURPOSE AND SCOPE

In order to avoid actual or perceived conflicts of interest for departmental employees engaging in outside employment, all employees shall obtain written approval from the Chief of Police prior to engaging in any outside employment. Approval of outside employment shall be at the discretion of the Chief of Police in accordance with the provisions of this policy.

1019.1.1 DEFINITIONS

Outside Employment - Any member of this department who receives wages, compensation or other consideration of value from another employer, organization or individual not affiliated directly with this department for services, product(s) or benefits rendered. For purposes of this section, the definition of outside employment includes those employees who are self-employed and not affiliated directly with this department for services, product(s) or benefits rendered.

Outside Overtime - Any member of this department who performs duties or services on behalf of an outside organization, company, or individual within this jurisdiction. Such outside overtime shall be requested and scheduled directly through this department so that the Department may be reimbursed for the cost of wages and benefits.

1019.2 OBTAINING APPROVAL

No member of this department may engage in any outside employment without first obtaining prior written approval of the Chief of Police. Failure to obtain prior written approval for outside employment or engaging in outside employment prohibited by this policy may lead to disciplinary action.

In order to obtain approval for outside employment, the employee must complete an Outside Employment Application which shall be submitted to the employee's immediate supervisor. The application will then be forwarded through channels to the Chief of Police for consideration.

If approved, the employee will be provided with a copy of the approved permit. Unless otherwise indicated in writing on the approved permit, a permit will be valid through the end of the calendar year in which the permit is approved. Any employee seeking to renew a permit shall submit a new Outside Employment Application in a timely manner.

Any employee seeking approval of outside employment, whose request has been denied, shall be provided with a written reason for the denial of the application at the time of the denial (Penal Code § 70(e)(3)).

1019.2.1 APPEAL OF DENIAL OF OUTSIDE EMPLOYMENT

If an employee's Outside Employment Application is denied or withdrawn by the Department, the employee may file a written notice of appeal to the Chief of Police within ten days of the date of denial.

Culver City Police Department

Culver City PD Policy Manual

Outside Employment

If the employee's appeal is denied, the employee may file a grievance pursuant to the procedure set forth in the current Memorandum of Understanding (MOU).

1019.2.2 REVOCATION/SUSPENSION OF OUTSIDE EMPLOYMENT PERMITS

Any outside employment permit may be revoked or suspended under the following circumstances:

- (a) Should an employee's performance at this department decline to a point where it is evaluated by a supervisor as needing improvement to reach an overall level of competency, the Chief of Police may, at his or her discretion, revoke any previously approved outside employment permit(s). That revocation will stand until the employee's performance has been reestablished at a satisfactory level and his/her supervisor recommends reinstatement of the outside employment permit
- (b) Suspension or revocation of a previously approved outside employment permit may be included as a term or condition of sustained discipline
- (c) If, at any time during the term of a valid outside employment permit, an employee's conduct or outside employment conflicts with the provisions of department policy, the permit may be suspended or revoked
- (d) When an employee is unable to perform at a full duty capacity due to an injury or other condition, any previously approved outside employment permit may be subject to similar restrictions as those applicable to the employee's full time duties until the employee has returned to a full duty status

1019.3 PROHIBITED OUTSIDE EMPLOYMENT

Consistent with the provisions of Government Code § 1126, the Department expressly reserves the right to deny any Outside Employment Application submitted by an employee seeking to engage in any activity which:

- (a) Involves the employee's use of departmental time, facilities, equipment or supplies, the use of the Department badge, uniform, prestige or influence for private gain or advantage
- (b) Involves the employee's receipt or acceptance of any money or other consideration from anyone other than this department for the performance of an act which the employee, if not performing such act, would be required or expected to render in the regular course or hours of employment or as a part of the employee's duties as a member of this department
- (c) Involves the performance of an act in other than the employee's capacity as a member of this department that may later be subject directly or indirectly to the control, inspection, review, audit or enforcement of any other employee of this department
- (d) Involves time demands that would render performance of the employee's duties for this department less efficient

Culver City Police Department

Culver City PD Policy Manual

Outside Employment

1019.3.1 OUTSIDE SECURITY AND PEACE OFFICER EMPLOYMENT

Consistent with the provisions of Penal Code § 70, and because it would further create a potential conflict of interest, no member of this department may engage in any outside or secondary employment as a private security guard, private investigator or other similar private security position.

Any private organization, entity or individual seeking special services for security or traffic control from members of this department must submit a written request to the Chief of Police in advance of the desired service. Such outside extra duty overtime assignments will be assigned, monitored and paid through the Department.

- (a) The applicant will be required to enter into an indemnification agreement prior to approval.
- (b) The applicant will further be required to provide for the compensation and full benefits of all employees requested for such outside security services.
- (c) Should such a request be approved, any employee working outside overtime shall be subject to the following conditions:
 - 1. The officer(s) shall wear the departmental uniform/identification.
 - 2. The officer(s) shall be subject to the rules and regulations of this department.
 - 3. No officer may engage in such outside employment during or at the site of a strike, lockout, picket, or other physical demonstration of a labor dispute.
 - 4. Compensation for such approved outside security services shall be pursuant to normal overtime procedures.
 - 5. Outside security services shall not be subject to the collective bargaining process.
 - 6. No officer may engage in outside employment as a peace officer for any other public agency without prior written authorization of the Chief of Police.

1019.3.2 OUTSIDE OVERTIME ARREST AND REPORTING PROCEDURE

Any employee making an arrest or taking other official police action while working in an approved outside overtime assignment shall be required to complete all related reports in a timely manner pursuant to department policy. Time spent on the completion of such reports shall be considered incidental to the outside overtime assignment.

1019.3.3 SPECIAL RESTRICTIONS

Except for emergency situations or with prior authorization from the Division Commander, undercover officers or officers assigned to covert operations shall not be eligible to work overtime or other assignments in a uniformed or other capacity which might reasonably disclose the officer's law enforcement status.

Culver City Police Department

Culver City PD Policy Manual

Outside Employment

1019.4 DEPARTMENT RESOURCES

Employees are prohibited from using any department equipment or resources in the course of or for the benefit of any outside employment. This shall include the prohibition of access to official records or databases of this department or other agencies through the use of the employee's position with this department.

1019.4.1 REVIEW OF FINANCIAL RECORDS

Employees approved for outside employment expressly agree that their personal financial records may be requested and reviewed/audited for potential conflict of interest (Government Code § 3308; Government Code § 1126). Prior to providing written approval for an outside employment position, the Department may request that an employee provide his/her personal financial records for review/audit in order to determine whether a conflict of interest exists. Failure of the employee to provide the requested personal financial records could result in denial of the off-duty work permit. If, after approving a request for an outside employment position, the Department becomes concerned that a conflict of interest exists based on a financial reason, the Department may request that the employee provide his/her personal financial records for review/audit. If the employee elects not to provide the requested records, his/her off-duty work permit may be revoked pursuant to the Revocation/Suspension of Outside Employment Permits section of this policy.

1019.5 CHANGES IN OUTSIDE EMPLOYMENT STATUS

If an employee terminates his or her outside employment during the period of a valid permit, the employee shall promptly submit written notification of such termination to the Chief of Police through channels. Any subsequent request for renewal or continued outside employment must thereafter be processed and approved through normal procedures set forth in this policy.

Employees shall also promptly submit in writing to the Chief of Police any material changes in outside employment including any change in the number of hours, type of duties, or demands of any approved outside employment. Employees who are uncertain whether a change in outside employment is material are advised to report the change.

1019.6 OUTSIDE EMPLOYMENT WHILE ON DISABILITY

Department members engaged in outside employment who are placed on disability leave or modified/light-duty shall inform their immediate supervisor in writing within five days whether or not they intend to continue to engage in such outside employment while on such leave or light-duty status. The immediate supervisor shall review the duties of the outside employment along with any related doctor's orders, and make a recommendation to the Chief of Police whether such outside employment should continue.

In the event the Chief of Police determines that the outside employment should be discontinued or if the employee fails to promptly notify his/her supervisor of his/her intentions regarding their work permit, a notice of revocation of the member's permit will be forwarded to the involved employee, and a copy attached to the original work permit.

Criteria for revoking the outside employment permit include, but are not limited to, the following:

Culver City Police Department

Culver City PD Policy Manual

Outside Employment

- (a) The outside employment is medically detrimental to the total recovery of the disabled member, as indicated by the City's professional medical advisors.
- (b) The outside employment performed requires the same or similar physical ability, as would be required of an on-duty member.
- (c) The employee's failure to make timely notice of their intentions to their supervisor.

When the disabled member returns to full duty with the Culver City Police Department, a request (in writing) may be made to the Chief of Police to restore the permit.

Occupational Disease and Work-Related Injury Reporting

1020.1 PURPOSE AND SCOPE

The purpose of this policy is to provide guidance regarding the timely reporting of occupational diseases, mental health issues, and work-related injuries.

1020.1.1 DEFINITIONS

Definitions related to this policy include:

Occupational disease or work-related injury - An injury, disease, or mental health issue arising out of employment (Labor Code § 3208; Labor Code § 3208.3; Labor Code § 3212 et seq.).

1020.2 POLICY

The Culver City Police Department will address occupational diseases and work-related injuries appropriately, and will comply with applicable state workers' compensation requirements (Labor Code § 3200 et seq.).

1020.2.1 ACCIDENT DEFINED

Accident - is defined as any occurrence from which bodily injury or property damage may result, regardless of whether any injury or damage actually does occur (e.g., exposure where no immediate injury is apparent).

1020.3 RESPONSIBILITIES

1020.3.1 MEMBER RESPONSIBILITIES

Any member sustaining any occupational disease or work-related injury shall report such event as soon as practicable, but within 24 hours, to a supervisor, and shall seek medical care when appropriate (8 CCR 14300.35).

1020.3.2 SUPERVISOR RESPONSIBILITIES

A supervisor learning of any occupational disease or work-related injury should ensure the member receives medical care as appropriate.

Supervisors shall ensure that required documents regarding workers' compensation are completed and forwarded promptly. Any related Citywide disease- or injury-reporting protocol shall also be followed.

Supervisors shall determine whether the Major Incident Notification and Illness and Injury Prevention policies apply and take additional action as required.

1020.3.3 BUREAU COMMANDER RESPONSIBILITIES

The Bureau Commander who receives a report of an occupational disease or work-related injury should review the report for accuracy and determine what additional action should be taken. The report shall then be forwarded to the Chief of Police, the City's risk management entity, and

Culver City Police Department

Culver City PD Policy Manual

Occupational Disease and Work-Related Injury Reporting

the Administration Bureau Bureau Commander to ensure any required Division of Occupational Health and Safety Administration (Cal/OSHA) reporting is made as required in the illness and injury prevention plan identified in the Illness and Injury Prevention Policy.

1020.3.4 CHIEF OF POLICE RESPONSIBILITIES

The Chief of Police shall review and forward copies of the report to the Personnel and Training. Copies of the report and related documents retained by the Department shall be filed in the member's confidential medical file.

1020.4 OTHER DISEASE OR INJURY

Diseases and injuries caused or occurring on-duty that do not qualify for workers' compensation reporting shall be documented on the designated report of injury form, which shall be signed by a supervisor. A copy of the completed form shall be forwarded to the appropriate Bureau Commander through the chain of command and a copy sent to the Administration Bureau Bureau Commander.

Unless the injury is extremely minor, this report shall be signed by the affected member, indicating that he/she desired no medical attention at the time of the report. By signing, the member does not preclude his/her ability to later seek medical attention.

1020.5 SETTLEMENT OFFERS

When a member sustains an occupational disease or work-related injury that is caused by another person and is subsequently contacted by that person, his/her agent, insurance company or attorney and offered a settlement, the member shall take no action other than to submit a written report of this contact to his/her supervisor as soon as possible.

1020.5.1 NO SETTLEMENT WITHOUT PRIOR APPROVAL

No less than 10 days prior to accepting and finalizing the settlement of any third-party claim arising out of or related to an occupational disease or work-related injury, the member shall provide the Chief of Police with written notice of the proposed terms of such settlement. In no case shall the member accept a settlement without first providing written notice to the Chief of Police. The purpose of such notice is to permit the City to determine whether the offered settlement will affect any claim the City may have regarding payment for damage to equipment or reimbursement for wages against the person who caused the disease or injury, and to protect the City's right of subrogation, while ensuring that the member's right to receive compensation is not affected.

Uniform Regulations

1021.1 PURPOSE AND SCOPE

The uniform policy of the Culver City Police Department is established to ensure that uniformed officers will be readily identifiable to the public through the proper use and wearing of department uniforms. Employees should also refer to the following associated policies:

Department Owned and Personal Property

Body Armor

Personal Appearance Standards

The Uniform and Equipment Specifications manual is maintained and periodically updated by the Chief of Police or his/her designee. That manual should be consulted regarding authorized equipment and uniform specifications.

The Culver City Police Department will provide uniforms for all employees required to wear them in the manner, quantity and frequency agreed upon in the respective employee group's collective bargaining agreement.

1021.2 WEARING AND CONDITION OF UNIFORM AND EQUIPMENT

Police employees wear the uniform to be identified as the law enforcement authority in society. The uniform also serves an equally important purpose to identify the wearer as a source of assistance in an emergency, crisis, or other time of need.

- (a) Uniform and equipment shall be maintained in a serviceable condition and shall be ready at all times for immediate use. Uniforms shall be neat, clean, and appear professionally pressed.
- (b) All peace officers of this department shall possess and maintain at all times, a serviceable uniform and the necessary equipment to perform uniformed field duty.
- (c) Personnel shall wear only the uniform specified for their rank and assignment (Penal Code § 13655).
- (d) The uniform is to be worn in compliance with the specifications set forth in the department's uniform specifications that are maintained separately from this policy.
- (e) All supervisors will perform periodic inspections of their personnel to ensure conformance to these regulations.
- (f) Civilian attire shall not be worn in combination with any distinguishable part of the uniform.
- (g) Uniforms are only to be worn while on duty, while in transit to or from work, for court, or at other official department functions or events.
- (h) If the uniform is worn while in transit, an outer garment shall be worn over the uniform shirt so as not to bring attention to the employee while he/she is off-duty.

Culver City Police Department

Culver City PD Policy Manual

Uniform Regulations

- (i) Employees are not to purchase or drink alcoholic beverages while wearing any part of the department uniform, including the uniform pants.
- (j) Mirrored sunglasses will not be worn with any Department uniform.
- (k) Visible jewelry, other than those items listed below, shall not be worn with the uniform unless specifically authorized by the Chief of Police or the authorized designee.
 - 1. Wrist watch
 - 2. Wedding ring, class ring, or other ring of tasteful design. A maximum of one ring/set may be worn on each hand
 - 3. Medical alert bracelet

1021.2.1 DEPARTMENT ISSUED IDENTIFICATION

The Department issues each employee an official department identification card bearing the employee's name, identifying information and photo likeness. All employees shall be in possession of their department issued identification card at all times while on duty or when carrying a concealed weapon.

- (a) Whenever on duty or acting in an official capacity representing the department, employees shall display their department issued identification in a courteous manner to any person upon request and as soon as practical.
- (b) Officers working specialized assignments may be excused from the possession and display requirements when directed by their Bureau Commander.

1021.3 UNIFORM CLASSES

1021.3.1 CLASS A UNIFORM

The Class A uniform is to be worn on special occasions such as funerals, graduations, ceremonies, or as directed. The Class A uniform is required for all sworn personnel. The Class A uniform includes the standard issue uniform with:

- (a) Long sleeve shirt with black tie
- (b) Polished black shoes or boots
- (c) Navy blue "peaked" style hat with a departmentally approved hat piece (badge) affixed to the front. This hat shall be worn at all outdoor special occasions where a class A uniform is directed to be worn, or at the discretion of the Chief of Police or designee. Personnel of the Culver City Police Department will be required to purchase a Class A hat. The Department will be responsible for issuing the approved hat piece (badge).

Boots with pointed or steel toes are not permitted.

1021.3.2 CLASS B UNIFORM

All officers will possess and maintain a serviceable Class B uniform at all times.

The Class B uniform will consist of the same garments and equipment as the Class A uniform with the following exceptions:

Culver City Police Department

Culver City PD Policy Manual

Uniform Regulations

- (a) The long or short sleeve shirt may be worn with the collar open. No tie is required
- (b) A black crew neck t-shirt must be worn with the uniform
- (c) All shirt buttons must remain buttoned except for the last button at the neck
- (d) Shoes for the Class B uniform may be as described in the Class A uniform
- (e) Approved all black polished shoes may be worn
- (f) Boots with pointed or steel toes are not permitted

1021.3.3 CLASS C UNIFORM

The Class C uniform may be established to allow field personnel cooler clothing during the summer months or special duty. The Chief of Police will establish the regulations and conditions for wearing the Class C Uniform and the specifications for the Class C Uniform.

1021.3.4 PATROL SUMMER UNIFORM

The Chief of Police or designee may authorize an alternative Patrol Summer Uniform to be worn by sworn personnel assigned to the Operations Bureau, Patrol.

The Patrol Summer Uniform shall be worn during the period of **July 1 through September 30** and shall conform to the following specifications:

- (a) **Police Polo Shirt** - Black in color, same as or indistinguishable from the Elbeco LFX style shirt which must include white silkscreen and/or embroidered images with all of the following identifying characteristics:
 - Culver City Police badge image on the left front side of the torso in the same area where the regular badge is generally positioned.
 - "POLICE" centered and immediately below the badge image.
 - Culver City Police Department patch image positioned on each shoulder.
 - Name of the officer embroidered in 3/4" white lettering on the right front side of the torso and centered along the horizontal prolongation of the bottom button.
 - "POLICE" centered across the upper back.
- (b) **Trousers** - Trousers for this uniform shall fit the following criteria:
 - Utility trousers, black in color.
 - Cotton material, full length, single colored,
 - Designed with front, rear, and cargo-style pockets.
 - Able to accommodate a uniform belt and attached Sam Browne utility belt.
- (c) **Boots/Shoes** - Plain black leather shoes or boots shall be worn.
 1. The boots/shoes shall be capable of taking a shine,
 2. Any insignia present on the boots or shoes shall be black.
 3. Laces shall be black.

Culver City Police Department

Culver City PD Policy Manual

Uniform Regulations

In the interest of maintaining a professional appearance, officers electing to wear the optional Patrol Summer Uniform shall coordinate uniform selection with their daily assigned partners to ensure uniformity.

The Patrol Summer Uniform is not authorized for court appearances and/or courtroom testimony.

In the event of inclement weather outside of the period specified above, the authorization of the Patrol Summer Uniform shall be at the discretion of the bureau/section Lieutenant or higher.

1021.3.5 DRESS POLO SHIRT

The Chief of Police or designee may authorize a Dress Polo shirt to be worn by sworn personnel and professional staff assigned to the Special Operations Bureau and/or Administration Bureau assignments.

The Dress Polo may be worn throughout the year and shall conform to the following specifications:

- Only an approved professional polo-style shirt, with three buttons and a collar, may be worn.
- The shirt shall be either dark gray or light gray in color and have no visible or discernible patterns; solid colors only.
- The shirt shall have no brand emblems, visible insignias, or logos.
- The upper right side of the shirt shall read "Culver City Police."
- The upper left side of the shirt shall read rank (e.g., DET., SGT., LT.) and last name. (ex. "DET. LAST NAME.")
 - The light gray shirt shall be embroidered in black lettering.
 - The dark gray shirt shall be embroidered in white lettering.

The Dress Polo is not authorized for court appearances and/or courtroom testimony. Additionally, the use of the Dress Polo shall remain at the discretion of any Supervisor and/or Department Manager in an Employee's chain of command. Employees may be directed to don alternative uniforms authorized by the Department where the Dress Polo would be inappropriate (i.e., meetings, city functions, other interactions with members of the public, etc.).

1021.3.6 SPECIALIZED UNIT UNIFORMS

The Chief of Police may authorize special uniforms to be worn by officers in specialized units such as Canine Team, Bicycle Patrol, Motor Officers and other specialized assignments.

1021.3.7 FOUL WEATHER GEAR

The Uniform and Equipment Specifications lists the authorized uniform jacket and rain gear.

1021.3.8 HONOR GUARD UNIFORMS

Honor Guard Class A - The Honor Guard Class A uniform shall include the following:

- The police high-collar dress coat, navy blue in color.
- Dress uniform trousers, navy blue in color, with a silver cord along the outside seam.

Culver City Police Department

Culver City PD Policy Manual

Uniform Regulations

- Felt campaign hat, navy blue in color, with a silver cord around the brim and departmentally approved hat piece (badge) affixed to the front.

Honor Guard Class B - The Honor Guard Class B uniform shall be the Department's class "A" uniform, outlined in section 1021.3.1 of this Manual. With the approval of a Bureau commander, a white ascot, white shoulder cord, and white gloves may also be worn with this uniform.

1021.4 INSIGNIA AND PATCHES

- (a) **Shoulder Patches** - The authorized shoulder patch supplied by the Department shall be machine stitched to the sleeves of all uniform shirts and jackets, three-quarters of an inch below the shoulder seam of the shirt and be bisected by the crease in the sleeve.
- (b) **Service stripes, etc.** - Service stripes and other indicators for length of service may be worn on long sleeved shirts and jackets. They are to be machine stitched onto the uniform. The bottom of the service stripe shall be sewn the width of one and one-half inches above the cuff seam with the rear of the service stripes sewn on the dress of the sleeve. The stripes are to be worn on the left sleeve only.
- (c) **The regulation nameplate** (silver with navy blue lettering), or an authorized sewn on cloth nameplate, shall be worn at all times while in uniform. The nameplate shall display the employee's last name. The nameplate shall be worn and placed above the right pocket located in the middle, bisected by the pressed shirt seam, with equal distance from both sides of the nameplate to the outer edge of the pocket.
- (d) **When a jacket is worn**, the nameplate or an authorized sewn on cloth nameplate shall be affixed to the jacket in the same manner as the uniform.
- (e) **Assignment Insignias** - Assignment insignias, (FTO, etc.) may be worn as designated by the Chief of Police.
- (f) **Flag Pin** - A flag pin may be worn, centered above the nameplate.
- (g) **Badge** - The department issued badge, or a rank appropriate cloth replica, must be worn and visible at all times while in uniform.
- (h) **Rank Insignia** - The designated insignia indicating the employee's rank must be worn at all times while in uniform. The Chief of Police may authorize exceptions.
- (i) **Military Ribbons**: Uniformed personnel who are active or former members of the U.S. military may have earned medals and/or ribbons during their military service. These members of the Department are authorized to wear such ribbons on their Class A uniform (ribbons only; no medals). Ribbons will be centered above the right breast pocket flap and nameplate. No other military medals and/or awards will be worn on the police uniform (e.g., parachutist badge, naval aviator wings, etc.)

1021.4.1 MOURNING BADGE

Uniformed employees shall wear a black mourning band across the uniform badge whenever a law enforcement officer is killed in the line of duty. The following mourning periods will be observed:

- (a) **An officer of this department** - From the time of death until midnight on the 14th day after the death.

Culver City Police Department

Culver City PD Policy Manual

Uniform Regulations

- (b) An officer from this or an adjacent county - From the time of death until midnight on the day of the funeral.
- (c) Funeral attendee - While attending the funeral of an out of region fallen officer.
- (d) National Peace Officers Memorial Day (May 15th) - From 0001 hours until 2359 hours.
- (e) As directed by the Chief of Police.

1021.5 CIVILIAN ATTIRE

There are assignments within the Department that do not require the wearing of a uniform because recognition and authority are not essential to their function. There are also assignments in which the wearing of civilian attire is necessary.

- (a) All employees shall wear clothing that fits properly, is clean and free of stains, and not damaged or excessively worn.
- (b) All male administrative, investigative and support personnel who elect to wear civilian clothing to work shall wear button style shirts with a collar, slacks or suits that are moderate in style.
- (c) All female administrative, investigative, and support personnel who elect to wear civilian clothes to work shall wear dresses, slacks, shirts, blouses, or suits which are moderate in style.
- (d) The following items shall not be worn on duty:
 - 1. T-shirt alone
 - 2. Open toed sandals or thongs
 - 3. Swimsuit, tube tops, or halter-tops
 - 4. Spandex type pants or see-through clothing
 - 5. Distasteful printed slogans, buttons or pins
- (e) Variations from this order are allowed at the discretion of the Chief of Police or designee when the employee's assignment or current task is not conducive to the wearing of such clothing.
- (f) No item of civilian attire may be worn on duty that would adversely affect the reputation of the Culver City Police Department or the morale of the employees.

1021.6 POLITICAL ACTIVITIES, ENDORSEMENTS, AND ADVERTISEMENTS

Unless specifically authorized by the Chief of Police, Culver City Police Department employees may not wear any part of the uniform, be photographed wearing any part of the uniform, utilize a department badge, patch or other official insignia, or cause to be posted, published, or displayed, the image of another employee, or identify himself/herself as an employee of the Culver City Police Department to do any of the following (Government Code §§ 3206 and 3302):

- (a) Endorse, support, oppose, or contradict any political campaign or initiative.
- (b) Endorse, support, oppose, or contradict any social issue, cause, or religion.

Culver City Police Department

Culver City PD Policy Manual

Uniform Regulations

- (c) Endorse, support, or oppose, any product, service, company or other commercial entity.
- (d) Appear in any commercial, social, or non-profit publication, or any motion picture, film, video, public broadcast, or any website.

1021.7 OPTIONAL EQUIPMENT - MAINTENANCE, AND REPLACEMENT

- (a) Any of the items listed in the Uniform and Equipment Specifications as optional shall be purchased totally at the expense of the employee. No part of the purchase cost shall be offset by the Department for the cost of providing the Department issued item.
- (b) Maintenance of optional items shall be the financial responsibility of the purchasing employee. For example, repairs due to normal wear and tear.
- (c) Replacement of items listed in this order as optional shall be done as follows:
 1. When the item is no longer functional because of normal wear and tear, the employee bears the full cost of replacement.
 2. When the item is no longer functional because of damage in the course of the employee's duties, it shall be replaced following the procedures for the replacement of damaged personal property (see the Department Owned and Personal Property Policy).

1021.7.1 RETIREE BADGES

The Chief of Police may issue identification in the form of a badge, insignia, emblem, device, label, certificate, card or writing that clearly states the person has honorably retired from the Culver City Police Department. This identification is separate and distinct from the identification authorized by Penal Code § 25455 and referenced in the Retired Officer CCW Endorsement Policy in this manual.

A badge issued to an honorably retired peace officer that is not affixed to a plaque or other memento will have the words "Honorably Retired" clearly visible on its face. A retiree shall be instructed that any such badge will remain the property of the Culver City Police Department and will be revoked in the event of misuse or abuse (Penal Code § 538d).

1021.8 UNAUTHORIZED UNIFORMS, EQUIPMENT AND ACCESSORIES

Culver City Police Department employees may not wear any uniform item, accessory or attachment unless specifically authorized in the Uniform and Equipment Specifications or by the Chief of Police or designee.

Culver City Police Department employees may not use or carry any safety item, tool or other piece of equipment unless specifically authorized in the Uniform and Equipment Specifications or by the Chief of Police or designee.

1021.9 BASIC UNIFORM: POLICE OFFICERS

Culver City Police Department

Culver City PD Policy Manual

Uniform Regulations

1021.9.1 BASIC UNIFORM REQUIREMENTS

The items named in this section shall constitute the basic uniform for Police Officers. No item of the basic uniform as specified, shall be substituted without prior permission of the Chief of Police.

1021.9.2 SWORN REQUIREMENTS

- (a) **Shirt** - The uniform shirt shall be an open collar navy blue shirt (long or short sleeve). All uniform shirts will have custom CCPD pewter-colored P-buttons affixed to each pocket and each epaulet, which shall be sewn down. A black crew-neck T-shirt shall be worn while in uniform; a plain black turtleneck shirt may be worn only when wearing a long sleeve uniform shirt. All uniform shirts shall have the departmentally approved patch sewn on both shoulders.
- (b) **Tie** - Black uniform style ties shall be worn on Class A dress occasions. (i.e. formal inspections, funerals, or any other occasion designated as Class A.)
- (c) **Class "A" Hat** - Navy blue "Peaked" style hats shall be worn on Class "A" dress occasions. (i.e. formal inspections, funerals, or any other occasion designated as Class "A"). All Class "A" hats shall have the departmentally approved hat piece (badge) affixed to the front. Class A hats shall have a silver hatband affixed to the front of the hat for personnel with the rank of Sergeant and above. Officers are not permitted to wear a silver hatband affixed to the front of the hat.
- (d) **Campaign Hats** - Navy blue campaign-style hats are approved for certain types of uniformed activities (i.e. mounted patrol, parade details, details in which prolonged exposure to the sun is expected, or any other detail with approval from the Watch Commander or a supervisor). Felt or straw construction are approved. All campaign hats shall have the departmentally approved hat piece (badge) affixed to the front. The hatband shall be of black leather construction.
- (e) **Baseball-Style Hats** - Departmentally approved black baseball-style hats may be worn while in uniform. The hat shall be made of black wool with "Culver City Police Department" embroidered in silver lettering on the front. It may not be worn while in the Class "A" uniform.
 - 1. Baseball-style hats are intended to offer field personnel protection from the sun and from inclement weather. Therefore, they are only authorized for outdoor use and shall not be worn indoors.
- (f) **Fleece Watch Caps** - Departmentally approved black fleece watch caps may be worn while in uniform. The watch cap shall be made of black fleece material with "CCPD" embroidered in silver lettering on the front of the cap.
 - 1. Watch caps are intended to offer field personnel protection from the cold and from inclement weather.
 - 2. Watch caps are only authorized during evening hours, from 1900 hours to 0700 hours.
 - (a) In the interest of uniformity, nothing in this policy shall limit the Chief's or his/her designee's discretion in prohibiting the use of the watch cap or during specified events (ex. a mutual aid response or special event assignments.)

Culver City Police Department

Culver City PD Policy Manual

Uniform Regulations

3. Watch caps are only authorized for outdoor use and shall not be worn indoors.
- (g) **Trousers** - Uniform trousers shall be navy blue. Low profile side leg pockets are optional.
- (h) **Trouser Belt** - Black basket weave leather or a nylon belt.
- (i) **Socks** - Black or dark blue.
- (j) **Shoes** - Plain black leather, capable of taking a shine, or plain black jogging shoes capable of being kept clean. Any insignia present on the boots or shoes shall be black. Laces shall be black.
- (k) **Badge** - When in the basic uniform, all officers shall wear the official issued badge. The badge shall be affixed to the uniform shirt on the upper left chest in the badge holder provided or on the outermost garment and shall be visible at all times. Officers, when dressed in the utility uniform or wearing a uniform jacket, shall affix a cloth replica badge in lieu of the metal issue.
- (l) **Identification Plate** - The name identification plate shall be affixed to the uniform right pocket lapel approximately 1/4 inch below the top stitch line and be centered above the right pocket P-Button. All officers shall wear silver-colored plates with Navy blue lettering. Officers shall wear 3/4 inch cloth nameplates (black with gray embroidered name) when dressed in the utility uniform. All embroidered uniform nameplates shall be affixed to the uniform shirt without marrow edging around the outer edge of the nameplate. Nameplates shall be sewn to the shirt using a zig-zag stitch.
- (m) **Identification Card** - When in uniform, all officers shall have in their possession the official identification card issued to them.
- (n) **Gloves** - Black leather, nylon, or plain black gloves may be worn when working in the field.

1021.9.3 POLICE JACKETS

- (a) **Patrol Jacket** - A black nylon or leather patrol jacket may be worn with the basic uniform. All jackets shall have the departmentally approved police patch sewn on each shoulder. All jackets shall also have a cloth replica badge sewn on the front upper left hand chest area. Jackets shall have 3/4 inch cloth nameplates (black with gray embroidered last name) sewn on just above the right chest pocket. All embroidered uniform nameplates shall be affixed to the uniform jacket without marrow edging around the outer edge of the nameplate. Nameplates shall be sewn to the jacket using a zig-zag stitch.
- (b) **Soft-Shell Jacket** - A nylon soft-shell jacket may be worn and shall include white silkscreen and/or embroidered images with all of the following identifying characteristics:
 1. Culver City Police badge image on the left front side of the torso in the same area where the regular badge is generally positioned.
 2. Culver City Police Department patch image positioned on each shoulder.

Culver City Police Department

Culver City PD Policy Manual

Uniform Regulations

3. Name of the officer embroidered in 3/4" white lettering on the right front side of the torso and centered along the horizontal prolongation of the bottom button.

These standards will also apply to all police-style jackets worn by civilian employees.

1021.9.4 UTILITY UNIFORM

- (a) **Shirt** - The shirt shall be black open collar, button front (it may be closed with a hidden zipper) with two flap pockets, long or short sleeves, worn with a black crew neck t-shirt. It shall be of cotton or cotton blend material. The pockets shall be secured with hook-and-loop fastener or hidden buttons. A rank appropriate cloth badge shall be worn above the left pocket. "The officer's last name shall be on a cloth-embroidered nameplate approximately 3/4" tall. It shall be gray embroidery on a black background. It shall be affixed above the right pocket of the shirt and shall not extend beyond the edges of the pocket. Culver City Police Department shoulder patches shall be affixed to each shoulder. Epaulets are not worn with this shirt. The shirt shall adhere to military specifications.
- (a) **Trousers** - The trousers shall match the shirt in color and material. It shall adhere to military specifications. It shall have two slash pockets, two rear pockets and two cargo pockets. The rear and cargo pockets shall be covered with flaps secured with Velcro or hidden buttons. Up to two flashlight pockets are authorized. Blousing of the pants is optional.
- (b) **Boots** - Standard boots shall be worn with this uniform.

1021.9.5 SPECIAL OPERATIONS UNIFORM

- (a) **Raid Jacket** - Black jacket, same as or indistinguishable from the 5.11 packable jacket (Style #48035) which must include silkscreened and/or embroidered images and all of the following identifying characteristics:
 1. Culver City Police badge image on the left front side of the torso in the same area where the regular badge is generally positioned.
 2. "POLICE" centered and immediately below the badge image.
 3. Culver City Police Department patch image positioned on each shoulder.
 4. Name of the officer embroidered in 3/4 " white lettering on the right front side of the torso and centered along the horizontal prolongation of the bottom button.
 5. "POLICE" centered across the upper back.
 6. Rank insignia (Sergeant Only) centered and positioned below the shoulder patch image.
- (b) **Police Polo Shirt** - Black in color, same as or indistinguishable from the Elbeco LFX style shirt which must include white silkscreen and/or embroidered images with all of the following identifying characteristics:
 1. Culver City Police badge image on the left front side of the torso in the same area where the regular badge is generally positioned.

Culver City Police Department

Culver City PD Policy Manual

Uniform Regulations

2. "POLICE" centered and immediately below the badge image.
3. Culver City Police Department patch image positioned on each shoulder.
4. Name of the officer embroidered in 3/4" white lettering on the right front side of the torso and centered along the horizontal prolongation of the bottom button.
5. "POLICE" centered across the upper back.

Plain black leather shoes or boots, capable of taking a shine, shall be worn. Any insignia present on the boots or shoes shall be black. Laces shall be black.

1021.9.6 CANINE HANDLER REQUIREMENTS

The items named in this section shall constitute the basic uniform for Canine Handlers. No item of the basic uniform as specified, shall be substituted without prior permission of the Chief of Police.

Canine handlers shall wear the Utility Uniform as their primary uniform. Upon approval of a supervisor, the Optional Uniform may be worn.

Optional Uniform:

- (a) **Shirt** - The shirt shall be a black T-shirt (long or short sleeve) with "Culver City" silk-screened in gray in an oval pattern (concave side down) above the top of a silk-screened Culver City Police Department badge and "K9" silkscreened in gray in a straight pattern below the bottom of the badge. This lettering shall be approximately 3/4" tall and shall be approximately 1/2" from the badge.
- (b) **Trousers** - The Utility Uniform Trousers will be worn with the Optional Uniform.
- (c) Culver City Police Department patch image positioned on each shoulder.
- (d) "POLICE" centered across the upper back.

1021.9.7 POLICE ADMINISTRATIVE UNIFORM

The items named in this section shall constitute the basic uniform for specific personnel authorized to wear the Police Administrative Uniform. No items of the Police Administrative Uniform as specified shall be substituted without prior permission of the Chief of Police.

- (a) **Shirt** - Black polo style shirt- same as or indistinguishable from the Elbeco LFX style shirt which must include white silkscreen and/or embroidered images with all of the following identifying characteristics:
 - Culver City Police badge image on the left front side of the torso in the same area where the regular badge would generally be positioned.
 - "POLICE" centered immediately below the badge image.
 - Culver City Police Department patch image positioned on each shoulder.
 - Name of the officer embroidered in 3/4" white lettering on the right front side of the torso and centered along the horizontal prolongation of the bottom button.
 - "POLICE" centered across the upper back.
 - A black crew-neck T-shirt shall be worn under the polo shirt.

Culver City Police Department

Culver City PD Policy Manual

Uniform Regulations

- (b) **Trousers** - Trousers for this uniform shall fit the following criteria; Utility trouser, black in color, composed of cotton, full length, single-colored, designed with front, rear and cargo style pockets, and able to accommodate a uniform belt and attached utility belt.
- (c) **Belt**- Black basketweave leather with silver-colored buckle.

Personnel may also be required to wear a suit or regular uniform. In those instances the employee would be subject to the same dress standards as other sworn personnel assigned to their specific bureau or those performing the same duties.

1021.9.8 SAM BROWNE BELT

The items named in this section shall be worn with the Sam Browne leather or nylon Belt. The Sam Browne leather Belt and all other leather items shall have chrome fixtures and basket weave design.

Required Equipment:

- (a) **Holster** - The holster shall be worn on the side for which it was designed (No Crossdraw). The official firearm shall be carried in the holster, unless otherwise authorized by the Chief of Police. If a nylon Sam Browne Belt is worn, the holster shall be black smooth leather or Kydex.
- (b) **Speed Loader Case** - The speed loader case shall be worn on the side opposite the holster and shall be centered on the belt between the belt buckle and the baton holder. At least twelve rounds of reserve ammunition shall be carried in the speed loader case.
- (c) **Magazine Pouch** - If an officer carries a semi-automatic handgun he/she shall wear a magazine pouch that holds at least two magazines. It shall be worn on the side opposite the holster.
- (d) **Baton Ring** - The baton holder shall be worn on the belt in front of, and directly adjacent to, the key holder. When worn, the baton is carried in the baton holder ring.
- (e) **Handcuff Case** - The handcuff case shall be worn centered over the hip pocket on the side opposite the holster. Regulation handcuffs shall be carried in the handcuff case. In the event two handcuff cases are carried the cases should be centered over each of the rear hip pockets.
- (f) **Keeper Straps** - At least four belt slide loops, commonly called keeper straps, shall be proportionately spaced with two loops worn in front and two loops in back. Each belt loop shall encircle both the Sam Browne belt and the trousers belt.
- (g) **AXON Holster** - The holster shall be worn on the opposite side of the firearm holster. The department issued AXON ECD shall be carried in the holster, unless otherwise authorized by the Chief of Police.

1021.9.9 UNIFORM ACCESSORIES

- (a) **Shoulder Patches** - All officers shall have the official Department emblem affixed to each shoulder of the uniform shirt and jacket. It shall be centered on the outer side of the sleeve with the top affixed approximately 3/4 inch below the shoulder seam.

Culver City Police Department

Culver City PD Policy Manual

Uniform Regulations

- (b) **Tie Bar** - If a tie is worn, the tie bar shall be silver in color, and shall be approximately the same in length as the tie wide. The tie bar shall be plain metal.
- (c) **Whistle Chain** - Whistle chains shall be worn by Traffic personnel only. They shall be silver in color and shall be worn on the right side with the top loop fastened to the right shoulder button and the bottom loop in the right pocket of the shirt. The pockets shall be secured so that the chain is held in proper position on the right-hand side of the right shirt pocket. The whistle chain is an optional uniform item. It shall be worn at the discretion of Operations Bureau Commander.
- (d) **"P" Buttons** - Pewter colored Gilt buttons (commonly called "P" buttons) shall be worn on both epaulets and both pockets of the field uniform shirt.
- (e) **Service Hash Marks** - For each five years of service as a police officer, including time served with other police agencies as a sworn officer, officers may wear one service hash mark on the field uniform long sleeve shirt. Service hash marks shall be silver in color and shall be worn on the outer left sleeve starting approximately 1/2 inch above the upper cuff seam. Service hash marks shall not be worn on the short-sleeve shirt. Civilian employees that wear a uniform may also wear service hash marks for years of service with the Culver City Police Department.
- (f) **Awards** - Length of service pins, firearms proficiency medals, and any other award medal approved by the Chief of Police may be worn on the lower right corner of the left shirt pocket flap. Medal of Valor and Distinguished Service bars shall be worn centered and directly above the flap of the left shirt pocket.

1021.9.10 RAIN EQUIPMENT

Rain Clothing Requirements - All personnel of the Department shall possess a yellow or black raincoat of a type approved by the Chief of Police.

Wearing of Rain Clothing - Uniformed personnel shall wear the prescribed rain clothing when required by weather conditions.

Storage of Rain Clothing - The prescribed rain clothing shall be stored at the station, office of assignment, or other place where it will be readily available for use.

1021.9.11 RANK INSIGNIA

All officers of the rank of training officer and above shall wear the insignia for their rank as provided in this section.

(a) **Training Officer Rank Insignia:**

1. Training Officer's chevrons (two silver) shall be worn on each sleeve of the uniform shirt. They shall be centered on the outer sleeve with the top point of the chevrons placed 1/4 inch below the bottom edge of the shoulder patch. Chevrons shall be placed on the Training Officer's field jacket midway between the elbow and shoulder. Shoulder patches shall be worn on the field jacket.

(b) **Sergeant Rank Insignia:**

1. Sergeant's chevrons (three silver) shall be worn on each sleeve of the uniform shirt. They shall be centered on the outer sleeve with the top point of the

Culver City Police Department

Culver City PD Policy Manual

Uniform Regulations

chevrons placed 1/4 inch below the bottom edge of the shoulder patch. Chevrons shall be placed on the Sergeant's field jacket midway between the elbow and shoulder. Shoulder patches shall be worn on the field jacket.

(c) **Lieutenant Rank Insignia:**

1. A single silver bar shall be affixed to the center of each side of the collar of the basic uniform shirt worn by Lieutenants. The front edge of the bar shall be 3/4 inch from, and parallel with, the front edge of the collar. A single silver bar shall be embroidered on the collar of the Utility Uniform. It shall be placed in the same location as on the basic uniform.

(d) **Captain Rank Insignia:**

1. The double silver bar rank insignia worn by Captains shall be affixed in the same relative positions as prescribed for Lieutenants.

(e) **Assistant Chief Rank Insignia:**

1. The three silver stars rank insignia worn by the Assistant Chief shall be affixed to the collar.

(f) **Chief:**

1. The four silver stars rank insignia worn by the Chief shall be affixed to the collar.

1021.9.12 DETECTIVE REQUIREMENTS

Personnel assigned to investigative details are required to wear professional business attire.

Men shall wear dress shirts and dress slacks throughout the year. Ties, sport coats, and/or suit jackets will be optional for all sworn employees assigned to non-uniformed positions.

However, ties, sport coats, and/or suit jackets will be required for all anticipated courtroom testimony. Additionally, the direction to wear ties shall remain at the discretion of any Supervisor and/or Department Manager in an Employee's chain of command. Employees may be directed to wear ties where appropriate (i.e., investigative interviews, city functions, other interactions with members of the public, etc.).

All detectives shall dress conservatively and extremes in style shall be prohibited.

1021.9.13 MOTOR OFFICER UNIFORMS

Officers assigned to motorcycle units are subject to all of the uniform requirements set forth in this Policy Manual. These officers shall wear departmentally issued and or approved boots, helmets, gloves, eye protection, and trousers while riding a motorcycle. The Motor Officer Uniform consists of the Motor Officer Class A Uniform to be worn on special occasions such as funerals, graduations, ceremonies, or as directed, and the Motor Officer Class B Uniform to be worn during normal daily operations or as directed.

Motor Officer Class A Uniform - The Motor Officer Class A uniform shall include the following:

- (a) Long sleeve shirt (meeting Basic Uniform standards as set forth in paragraph 1021.9.2).

Culver City Police Department

Culver City PD Policy Manual

Uniform Regulations

- (b) Tie (meeting Basic Uniform standards as set forth in paragraph 1021.9.2)
- (c) Motor Officer breeches, wool or poly-blend, navy blue in color, with Department issued gray piping along the outside seam.
- (d) Trouser Belt (meeting Basic Uniform standards as set forth in paragraph 1021.9.2).
- (e) Traditional Motor Officer leather boots, coming up to just below the knee, black in color, and polished.
- (f) Badge (meeting Basic Uniform standards as set forth in paragraph 1021.9.2).
- (g) Identification Plate (meeting Basic Uniform standards as set forth in paragraph 1021.9.2).
- (h) Issued motorcycle helmet.
- (i) Gloves – leather, or heavy-duty nylon, protective gloves.
- (j) Protective glasses.
- (k) Issued Tourmaster Flex LE 2.0 or other pre-approved motorcycle jacket, black in color, to be worn as needed or directed.

Motor Officer Class B Uniform - The Motor Officer Class B uniform shall include the following:

OPTION 1

- (a) Short/long sleeve shirt (meeting Basic Uniform standards as set forth in paragraph 1021.9.2).
- (b) Motor Officer breeches, wool or poly-blend, navy blue in color, with Department issued gray piping along the outside seam.
- (c) Trouser Belt (meeting Basic Uniform standards as set forth in paragraph 1021.9.2).
- (d) Traditional Motor Officer leather boots, coming up to just below the knee, black in color, and polished.
- (e) Badge (meeting Basic Uniform standards as set forth in paragraph 1021.9.2).
- (f) Identification Plate (meeting Basic Uniform standards as set forth in paragraph 1021.9.2).
- (g) Issued motorcycle helmet.
- (h) Gloves – leather, or heavy-duty nylon, protective gloves.
- (i) Protective glasses.
- (j) Issued Tourmaster Flex LE 2.0 or other pre-approved motorcycle jacket, black in color, to be worn as needed or directed.

OR

OPTION 2

- (a) Police Polo Shirt (meeting Special Operations Uniform standards as set forth in paragraph 1021.9.5).

Culver City Police Department

Culver City PD Policy Manual

Uniform Regulations

OR

- (a) Load bearing vest with BDU shirt or pre-approved modified LBV undershirt (meeting Load Bearing Vest standards as set forth in paragraph 1021.11).
- (b) Motorcycle pants – Motoport Air Mesh motorcycle pants, black in color, with gray piping along the outer seam.
- (c) Trouser Belt (meeting Basic Uniform standards as set forth in paragraph 1021.9.2).
- (d) Boots – Sidi motorcycle boots or equivalent, leather, all black, with no visible external buckles, with a shaft extending above the ankle bone.
- (e) Issued motorcycle helmet.
- (f) Gloves – leather, or heavy-duty nylon, protective gloves.
- (g) Protective glasses.
- (h) Issued Tourmaster Flex LE 2.0 or other pre-approved motorcycle jacket, black in color, to be worn as needed or directed.

1021.9.14 RANGE STAFF REQUIREMENTS

The items named in this section shall constitute the basic uniform for range staff personnel. No item of the basic uniform as specified, shall be substituted without prior permission of the Chief of Police.

- (a) **Shirt** - The shirt shall be a black polo type shirt (long or short sleeve) with a silk screened badge on the left breast area. A black crew neck T-shirt shall be worn under the polo. With prior approval of the Administration and Investigations Bureau Commander, a black T-shirt with the same basic design (silk-screened) may be worn by range staff.
- (b) **Trousers** - The trousers for this uniform shall be the green Utility trousers.
- (c) **Boots/Shoes** - Plain black leather, capable of taking a shine, or plain black or green utility boots capable of being kept clean. Any insignia present on the boots or shoes shall be black. Laces shall be black.
- (d) **Belt** - Black basket weave leather with a silver-colored buckle. A nylon belt may also be worn.

1021.10 BASIC UNIFORM: PROFESSIONAL STAFF

1021.10.1

The items named in this section shall constitute the basic uniform for:

- (a) Community Service Officers
- (b) Mental Health Clinician
- (c) Forensic Specialists and Sr. Forensic Specialist
- (d) Parking Enforcement Supervisor
- (e) Parking Enforcement Officers

Culver City Police Department

Culver City PD Policy Manual

Uniform Regulations

- (f) Records Technicians and Records Supervisor
- (g) Computer Services Unit personnel
- (h) Property Technicians
- (i) Automated Enforcement Technician

No item of the basic uniform as specified, shall be substituted without prior permission of the Chief of Police.

- (a) **Shirt** - The uniform shirt shall be a black polyester polo style shirt, same as or indistinguishable from the Elbeco LFX style shirt which must include white silkscreen and/or embroidered images with all of the following identifiable characteristics:
 - Culver City Police" crescent positioned directly over horizontal lettering indicating the employee's assigned unit on the upper left front side of the shirt.
 - Culver City Police Department patch image positioned on each shoulder.
 - Last name of the employee embroidered on the upper right front side of the shirt and centered along the horizontal prolongation of the bottom button.
- (b) **Trousers/Skirts/Shorts** -Trousers shall be black and utility in style. Black slacks or skirts are allowed for non-field personnel including Communications Technicians, Records Technicians and Records Supervisor, and Automated Enforcement Technician. Skirts are to fall no shorter than 2" above the knee. Black utility shorts are allowed for Parking Enforcement Officers.
- (c) **Trouser Belt** - Black basketweave leather with a silver-colored buckle.
- (d) **Socks** - Black.
- (e) **Boots/Shoes** - Plain black leather, capable of taking a shine, or plain black shoes capable of being kept clean. Any insignia present on the boots or shoes shall be black in color. Laces shall be black.
- (f) **Identification Card** - When in uniform, all personnel shall have in their possession the official identification card issued to them.
- (g) **Basic Uniform Jacket** - The black nylon jacket may be worn with the uniform. Patches shall be the same as the uniform shirt. The embroidered nameplate shall be a black background with 3/4" gray lettering.
 - Culver City Police" crescent positioned directly over horizontal lettering indicating the employee's assigned unit on the upper left front side of the shirt.

1021.10.2 JAILER REQUIREMENTS

The items named in this section shall constitute the basic uniform for Jailers. No item of the basic uniform as specified, shall be substituted without prior permission of the Chief of Police.

- (a) **Shirt** - The shirt shall be a navy blue open-collar utility shirt, (long or short sleeve) with a black crew neck T-shirt. The shirt shall have CCPD shoulder patches on each shoulder and a "Jailer" patch centered on the outer sleeves with the top of the patch placed 1/4 inch below the bottom edge of the shoulder patch. This patch should be approximately 3" wide and 1" long.

Culver City Police Department

Culver City PD Policy Manual

Uniform Regulations

- (b) **Trousers** - The trousers shall match the shirt in color and material. It shall have two slash pockets, two rear pockets and two cargo pockets. The rear and cargo pockets shall be covered with flaps secured with Velcro or hidden buttons. Up to two flashlight pockets are authorized. Blousing of the pants is optional.
- (c) **Trouser Belt** - Black basketweave leather with a silver-colored buckle.
- (d) **Socks** - Black or dark blue.
- (e) **Boots/Shoes** - Plain black leather, capable of taking a shine. Any insignia present on the boots or shoes shall be black in color. Laces shall be black.
- (f) **Cloth Embroidered Name Plate** - The nameplate shall be affixed above the uniform right pocket. The nameplate shall be navy with silver lettering and shall be approximately 1" tall. It shall not extend beyond the edges of the pocket.
- (g) **Badge** - All jailers shall wear a cloth replica police badge on the upper left chest of their uniform marked "Jailer."
- (h) **Identification Card** - When in uniform, all Jailers shall have in their possession the official identification card issued to them.
- (i) **Basic Uniform Jacket** - The black nylon jacket may be worn with the uniform. The Jailer's last name shall be on a cloth-embroidered nameplate approximately 3/4" tall. It shall be gray embroidery on a black background. It shall be affixed above the left pocket of the jacket and shall not extend beyond the edges of the pocket. Badges shall be the same as the uniform shirt. The jacket shall have CCPD shoulder patches on each shoulder. A patch marked "Jailer" shall be centered on the outer sleeves with the top of the patch placed 1/4 inch below the bottom edge of the shoulder patch. This patch should be approximately 3" wide and 1" long.
- (j) **Rank Insignia**- Jailer assigned as the senior jailer shall wear one single silver chevron on each sleeve of the uniform shirt. It shall be centered on the outer sleeve with the top point of the chevron placed 1/4 inch below the bottom edge of the shoulder patch. The chevrons shall be placed on the Senior Jailer's field jacket midway between the elbow and shoulder. Shoulder patches shall be worn on the field jacket.

1021.10.3 POLICE RECRUIT REQUIREMENTS

The official Department uniform worn by Police Recruits attending the Basic Training Academy shall be determined by the specifications of the Academy presently contracting with the Department for such training. The training uniform shall be purchased by the recruit and is not reimbursable through the City's uniform allowance program.

1021.10.4 ANIMAL SERVICES OFFICER REQUIREMENTS

The items named in this section shall constitute the basic uniform for Animal Services Officers (ASO). No item of the basic uniform as specified shall be substituted without prior permission of the Chief of Police.

- (a) **Shirt** - The uniform shirt shall be an open collar olive green button up uniform type shirt (long or short sleeve) with a black crew neck T-shirt. The shirt shall have CCPD shoulder patches on each shoulder and an Animal Services Officer patch centered on

Culver City Police Department

Culver City PD Policy Manual

Uniform Regulations

the outer sleeves with the top of the patch placed 1/4 inch below the bottom edge of the shoulder patch. This patch should be approximately 3" wide and 1" long.

- (b) **Trousers** - The trousers shall be black or match the shirt in color. They shall have two slash pockets, two rear pockets and two cargo pockets. The rear and cargo pockets shall be covered with flaps secured with Velcro or hidden buttons. Up to two flashlight pockets are authorized. Blousing of the pants is optional.
- (c) **Trouser Belt** - Black leather basket weave belt with a silver colored buckle.
- (d) **Socks** - Black.
- (e) **Boots/Shoes** - Plain black leather, capable of taking a shine. Any visible insignia present on the boots or shoes shall be black. Laces shall be black.
- (f) **Name Patch** - A stitched name patch shall be affixed immediately above and centered over the uniform right pocket flap. It shall be olive green in color with black lettering.
- (g) **Badge** - All Animal Services Officers shall wear a cloth replica police badge on the upper left chest of their uniform marked "Animal Control."
- (h) **Identification Card** - When in uniform, all Animal Services Officers shall have in their possession the official identification card issued to them.
- (i) **Basic Uniform Jacket** - The black nylon jacket may be worn with the uniform. It shall have a cloth embroidered nameplate affixed above the uniform right pocket. The stitched nameplate shall be black with gray lettering and shall be approximately 3/4" tall. It shall not extend beyond the edges of the pocket. Badges and patches shall be the same as the uniform shirt.

1021.10.5 CUSTODIAN REQUIREMENTS

The items named in this section shall constitute the basic uniform for Custodians. No item of the basic uniform as specified, shall be substituted without prior permission of the Chief of Police.

- (a) **Shirt** - The uniform shirt shall be an open-collar light blue button up short-sleeve uniform type shirt with a white crew neck T-shirt. The shirt shall have a City of Culver City patch sewn onto the left shoulder.
- (b) **Trousers** - Uniform trousers shall be navy blue.
- (c) **Trouser Belt** - Black basket weave leather with a silver-colored buckle.
- (d) **Socks** - Black or dark blue.
- (e) **Boots/Shoes** - Plain black leather with a steel-toe, capable of taking a shine. The boots shall be replaced at the city's expense annually.
- (f) **Name Plate** - A cloth name patch shall be affixed above the uniform left pocket with the custodian's first name. The nameplate shall be white with blue lettering and shall be approximately 1" tall and shall not extend beyond the edges of the pocket.
- (g) **Identification Card** - When in uniform, all Custodians shall have in their possession the official identification card issued to them.
- (h) **Basic Uniform Jacket** - A navy blue jacket may be worn with the uniform. It shall have a cloth name patch affixed above the uniform left pocket. The nameplate shall be

Culver City Police Department

Culver City PD Policy Manual

Uniform Regulations

white with blue lettering and shall be approximately 1" tall and shall not extend beyond the edges of the pocket. The patch shall be the same as the uniform shirt.

1021.10.6 POLICE EXPLORER REQUIREMENTS

The items named in this section shall constitute the basic uniform for Police Explorers. No item of the basic uniform as specified shall be substituted without prior permission of the Chief of Police.

- (a) **Shirt** - The shirt shall be an open collar light blue shirt (long or short sleeve) with a white crew-neck t-shirt. The shirt shall have Departmentally approved shoulder patches on each shoulder and an "Explorer" patch centered on the outer sleeves with the top of the patch placed an inch below the bottom edge of the shoulder patch.
- (b) **Trousers** - The trousers shall be navy blue.
- (c) **Trouser Belt** - Black basketweave leather with a silver-colored buckle.
- (d) **Socks** - Black or dark blue.
- (e) **Boots/Shoes** - Plain black leather, capable of taking a shine, or plain black athletic shoes capable of being kept clean. Any insignia present on the boots or shoes shall be black in color. Laces shall be black.
- (f) **Identification Plate** - The name identification plate shall be affixed to the uniform right pocket lapel approximately 1/4 inch below the top stitch line and be centered above the right pocket button. All Explorers shall wear silver-colored plates with blue lettering.
- (g) **Badge** - All Explorers shall wear a cloth replica police badge on the upper left chest of their uniform marked "Explorer."
- (h) **Identification Card** - When in uniform, all Explorers shall have in their possession the official identification card issued to them.
- (i) **Basic Uniform Jacket** - The black nylon jacket may be worn with the uniform. The Explorer's last name shall be on a cloth-embroidered nameplate approximately 1" tall. It shall be silver embroidery on a black background. It shall be affixed above the right pocket of the jacket and shall not extend beyond the edges of the pocket. Badges shall be the same as the uniform shirt. The jacket shall have CCPD shoulder patches on each shoulder. An "Explorer" patch will be centered on the outer sleeves with the top of the patch placed 3/4 inches below the bottom edge of the shoulder patch. This patch shall be approximately 3" wide and 1" long.

1021.11 LOAD BEARING VESTS: SWORN PERSONNEL

Load Bearing Vests (LBVs) are authorized as an option to be worn by uniformed sworn personnel at the employee's own expense. The LBV is to be worn with BDU pants and a BDU shirt or a pre-approved modified LBV undershirt. Sworn personnel are subject to the following conditions:

- (a) The Point Blank LBV shall be authorized by the Chief of Police or designee. The LBV shall be black in color. A rank appropriate metal badge shall be worn above the left pocket. The officer's last name shall be on a cloth-embroidered nametape approximately 3/4 tall. It shall be gray embroidery on a black background. It shall be affixed above the right pocket of the shirt and shall not extend beyond the edges of the pocket.

Culver City Police Department

Culver City PD Policy Manual

Uniform Regulations

(b) Shirt - The shirt shall be black open collar, button front (it may be closed with a hidden zipper), long or short sleeves, worn with a black crew neck t-shirt. The shirt shall be of cotton or cotton blend material. Culver City Police Department shoulder patches shall be affixed to each shoulder. Shoulder epaulets shall be sewn down. The shirt shall adhere to military specifications.

(c) Trousers - The trousers shall match the shirt in color and material. It shall adhere to military specifications. It shall have two slash pockets, two rear pockets and two cargo pockets. The rear and cargo pockets shall be covered with flaps secured with Velcro or hidden buttons. Up to two flashlight pockets are authorized. Blousing of the pants is optional.

(d) The LBV will be worn in combination with a nylon duty belt and plain black holster (Kydex or smooth leather) along with key holder and baton ring. A drop holster may be used to ensure clear access to the duty weapon. "Thigh rig" style holsters are not authorized.

(e) A radio holder loop may be placed on the right or left shoulder.

(f) The following equipment should be transitioned from the duty belt to the LBV, provided they do not block visibility of the badge, name tape, BWC or patches:

(a) Handcuffs

(b) Primary ammunition magazines (maximum of 4, no rifle magazines)

(c) Pepper Spray

(d) Expandable baton (or baton ring on duty belt)

(e) Portable radio

(f) Flashlight

(g) "POLICE" is to be sewn on the back of the LBV centered across the upper back in all capital letters in plain two inch block font, silver in color. Canine handlers are permitted to affix "POLICE K-9" on the back of their LBV.

(h) Body Worn Cameras shall be affixed to the top hook and loop attachments closest to center chest, utilizing a plain black Tek-lok BWC Case.

(i) External pockets on the LBV will have flaps.

(j) Officers shall carry the Conducted Energy Weapon in a weak-side holster on the side opposite the duty weapon (Cross draw).

(k) When purchasing, officers should try the LBV on with their gun belt, ensuring pockets do not interfere with their duty weapon or other equipment.

(l) Flashlights longer than nine (9) inches are not permitted on the LBV.

(m) No firearms are permitted on the LBV.

(n) Rifle magazines are not permitted on the LBV.

(o) No equipment shall be affixed to the back of the LBV.

Culver City Police Department

Culver City PD Policy Manual

Uniform Regulations

(p) Uniformed personnel working as a two-officer unit shall wear the same uniform (duty belt or LBV). Field Training Officers working with a trainee are exempt from subsection "p".

(q) The LBV may be worn with the Bike Patrol Uniform.

(r) Supervisors will perform periodic inspections of their personnel to ensure conformance to these regulations, presentable, and in good working order. Officers shall always have their Class A and B uniform available in the event that a transition is deemed necessary by their supervisor.

(s) LBV's shall not be worn to court appearances or official ceremonies (i.e. funerals, swear-ins etc.) without prior authorization from a supervisor.

(t) Supervisors shall retain the discretion to allow or disallow the wearing of LBV's.

Nepotism and Conflicting Relationships

1022.1 PURPOSE AND SCOPE

The purpose of this policy is to ensure equal opportunity and effective employment practices by avoiding actual or perceived favoritism, discrimination or actual or potential conflicts of interest by or between members of this department. These employment practices include: recruiting, testing, hiring, compensation, assignment, use of facilities, access to training opportunities, supervision, performance appraisal, discipline and workplace safety and security.

1022.1.1 DEFINITIONS

Business relationship - Serving as an employee, independent contractor, compensated consultant, owner, board member, shareholder, or investor in an outside business, company, partnership, corporation, venture or other transaction, where the Department employee's annual interest, compensation, investment or obligation is greater than \$250.

Conflict of interest - Any actual, perceived or potential conflict of interest in which it reasonably appears that a department employee's action, inaction or decisions are or may be influenced by the employee's personal or business relationship.

Nepotism - The practice of showing favoritism to relatives over others in appointment, employment, promotion or advancement by any public official in a position to influence these personnel decisions.

Personal relationship - Includes marriage, cohabitation, dating or any other intimate relationship beyond mere friendship.

Public official - A supervisor, officer or employee vested with authority by law, rule or regulation or to whom authority has been delegated.

Relative - An employee's parent, stepparent, spouse, domestic partner, significant other, child (natural, adopted or step), sibling or grandparent.

Subordinate - An employee who is subject to the temporary or ongoing direct or indirect authority of a supervisor.

Supervisor - An employee who has temporary or ongoing direct or indirect authority over the actions, decisions, evaluation and/or performance of a subordinate employee.

1022.2 RESTRICTED DUTIES AND ASSIGNMENTS

The Department will not prohibit all personal or business relationships between employees. However, in order to avoid nepotism or other inappropriate conflicts, the following reasonable restrictions shall apply (Government Code § 12940):

- (a) Employees are prohibited from directly supervising, occupying a position in the line of supervision or being directly supervised by any other employee who is a relative or with whom they are involved in a personal or business relationship.

Culver City Police Department

Culver City PD Policy Manual

Nepotism and Conflicting Relationships

1. If circumstances require that such a supervisor/subordinate relationship exist temporarily, the supervisor shall make every reasonable effort to defer matters pertaining to the involved employee to an uninvolved supervisor.
 2. When personnel and circumstances permit, the Department will attempt to make every reasonable effort to avoid placing employees in such supervisor/subordinate situations. The Department, however, reserves the right to transfer or reassign any employee to another position within the same classification in order to avoid conflicts with any provision of this policy.
- (b) Employees are prohibited from participating in, contributing to or recommending promotions, assignments, performance evaluations, transfers or other personnel decisions affecting an employee who is a relative or with whom they are involved in a personal or business relationship.
 - (c) Whenever possible, FTOs and other trainers will not be assigned to train relatives. FTOs and other trainers are prohibited from entering into or maintaining personal or business relationships with any employee they are assigned to train until such time as the training has been successfully completed and the employee is off probation.
 - (d) To avoid actual or perceived conflicts of interest, members of this department shall refrain from developing or maintaining personal or financial relationships with victims, witnesses or other individuals during the course of or as a direct result of any official contact.
 - (e) Except as required in the performance of official duties or, in the case of immediate relatives, employees shall not develop or maintain personal or financial relationships with any individual they know or reasonably should know is under criminal investigation, is a convicted felon, parolee, fugitive or registered sex offender or who engages in serious violations of state or federal laws.

1022.2.1 EMPLOYEE RESPONSIBILITY

Prior to entering into any personal relationship which the employee knows or reasonably should know could create a conflict of interest or other violation of this policy, the employee shall promptly notify his/her uninvolved, next highest level of supervisor.

Whenever any employee is placed in circumstances that would require the employee to take enforcement action or provide official information or services to any relative or individual with whom the employee is involved in a personal relationship, the employee shall promptly notify his/her uninvolved, immediate supervisor. In the event that no uninvolved supervisor is immediately available, the employee shall promptly notify dispatch to have another uninvolved employee either relieve the involved employee or minimally remain present to witness the action.

An employee who is uncertain about the effect of a particular relationship should consult his/her supervisor.

1022.2.2 SUPERVISOR'S RESPONSIBILITY

Upon being notified of, or otherwise becoming aware of any circumstance that could result in or constitute an actual or potential violation of this policy, a supervisor shall take all reasonable steps

Culver City Police Department

Culver City PD Policy Manual

Nepotism and Conflicting Relationships

to promptly mitigate or avoid such violations whenever possible. Supervisors shall also promptly notify the Chief of Police of such actual or potential violations through the chain of command.

1022.3

1022.4

Department Badges

1023.1 PURPOSE AND SCOPE

The Culver City Police Department badge and uniform patch as well as the likeness of these items and the name of the Culver City Police Department are property of the Department and their use shall be restricted as set forth in this policy.

1023.2 POLICY

The uniform badge shall be issued to department members as a symbol of authority and the use and display of departmental badges shall be in strict compliance with this policy. Only authorized badges issued by this department shall be displayed, carried or worn by members while on duty or otherwise acting in an official or authorized capacity.

1023.2.1 FLAT BADGE

Sworn officers, with the written approval of the Chief of Police may purchase, at his/her own expense, a flat badge capable of being carried in a wallet. The use of the flat badge is subject to all the same provisions of departmental policy as the uniform badge.

- (a) An officer may sell, exchange, or transfer the flat badge he/she purchased to another officer within the Culver City Police Department with the written approval of the Chief of Police.
- (b) Should the flat badge become lost, damaged, or otherwise removed from the officer's control, he/she shall make the proper notifications as outlined in the Department Owned and Personal Property Policy.
- (c) An honorably retired officer may keep his/her flat badge upon retirement.
- (d) The purchase, carrying or display of a flat badge is not authorized for non-sworn personnel.

1023.2.2 PROFESSIONAL STAFF PERSONNEL

Badges and departmental identification cards issued to non-sworn personnel shall be clearly marked to reflect the position of the assigned employee (e.g. Parking Control, Dispatcher).

- (a) Non-sworn personnel shall not display any department badge except as a part of his/her uniform and while on duty, or otherwise acting in an official and authorized capacity.
- (b) Non-sworn personnel shall not display any department badge or represent him/herself, on or off duty, in such a manner which would cause a reasonable person to believe that he/she is a sworn peace officer.

Culver City Police Department

Culver City PD Policy Manual

Department Badges

1023.2.3 RETIREE UNIFORM BADGE

Upon honorable retirement employees may purchase his/her assigned duty badge for display purposes. It is intended that the duty badge be used only as private memorabilia as other uses of the badge may be unlawful or in violation of this policy.

1023.3 UNAUTHORIZED USE

Except as required for on-duty use by current employees, no badge designed for carry or display in a wallet, badge case or similar holder shall be issued to anyone other than a current or honorably retired peace officer.

Department badges are issued to all sworn employees and professional staff uniformed employees for official use only. The department badge, shoulder patch or the likeness thereof, or the department name shall not be used for personal or private reasons including, but not limited to, letters, memoranda, and electronic communications such as electronic mail or web sites and web pages.

The use of the badge, uniform patch and department name for all material (printed matter, products or other items) developed for department use shall be subject to approval by the Chief of Police.

Employees shall not loan his/her department badge or identification card to others and shall not permit the badge or identification card to be reproduced or duplicated.

1023.4 PERMITTED USE BY EMPLOYEE GROUPS

The likeness of the department badge shall not be used without the expressed authorization of the Chief of Police and shall be subject to the following:

- (a) The employee associations may use the likeness of the department badge for merchandise and official association business provided they are used in a clear representation of the association and not the Culver City Police Department. The following modifications shall be included:
 1. The text on the upper and lower ribbons is replaced with the name of the employee association.
 2. The badge number portion displays the acronym of the employee association.
- (b) The likeness of the department badge for endorsement of political candidates shall not be used without the expressed approval of the Chief of Police.

Seniority

1024.1 PURPOSE AND SCOPE

This purpose of this section is to provide information pertaining, but not limited, to issues of seniority, employee reimbursements, employee benefits, and funeral protocol.

1024.2 SENIORITY

1024.2.1 SENIORITY OF SWORN EMPLOYEES

Seniority shall be used to designate the hierarchical relationships among employees based upon:

- (a) Civil Service Rating.
- (b) Length of Service.
- (c) Eligibility List.

1024.2.2 OF CIVILIAN EMPLOYEES

Seniority of civilian employees shall be determined in the following order:

- (a) Civil Service Classification. In accordance with the Civil Service rating, whereby one position is classified as being higher in grade than another.
- (b) Length of Service. By length of continuous service in the classification.
- (c) Designation. When designated as being in charge of a particular situation or group by competent authority.

Temporary Modified-Duty Assignments

1025.1 PURPOSE AND SCOPE

This policy establishes procedures for providing temporary modified-duty assignments. This policy is not intended to affect the rights or benefits of employees under federal or state law, City rules, current memorandums of understanding, or collective bargaining agreements. For example, nothing in this policy affects the obligation of the Department to engage in a good faith, interactive process to consider reasonable accommodations for any employee with a temporary or permanent disability or limitation that is protected under federal or state law.

1025.2 POLICY

Subject to operational considerations, the Culver City Police Department may identify temporary modified-duty assignments for employees who have an injury or medical condition resulting in temporary work limitations or restrictions. A temporary assignment allows the employee to work, while providing the Department with a productive employee during the temporary period.

1025.3 GENERAL CONSIDERATIONS

Priority consideration for temporary modified-duty assignments will be given to employees with work-related injuries or illnesses that are temporary in nature. Employees having disabilities covered under the Americans with Disabilities Act (ADA) or the California Fair Employment and Housing Act (Government Code § 12940 et seq.) shall be treated equally, without regard to any preference for a work-related injury.

No position in the Culver City Police Department shall be created or maintained as a temporary modified-duty assignment.

Temporary modified-duty assignments are a management prerogative and not an employee right. The availability of temporary modified-duty assignments will be determined on a case-by-case basis, consistent with the operational needs of the Department. Temporary modified-duty assignments are subject to continuous reassessment, with consideration given to operational needs and the employee's ability to perform in a modified-duty assignment.

The Chief of Police or the authorized designee may restrict employees working in temporary modified-duty assignments from wearing a uniform, displaying a badge, carrying a firearm, operating an emergency vehicle or engaging in outside employment, or may otherwise limit them in employing their peace officer powers.

Temporary modified-duty assignments shall generally not exceed a cumulative total of 1,040 hours in any one-year period.

1025.4 PROCEDURE

Employees may request a temporary modified-duty assignment for short-term injuries or illnesses.

Culver City Police Department

Culver City PD Policy Manual

Temporary Modified-Duty Assignments

Employees seeking a temporary modified-duty assignment should submit a written request to their Bureau Commanders or the authorized designees. The request should, as applicable, include a certification from the treating medical professional containing:

- (a) An assessment of the nature and probable duration of the illness or injury.
- (b) The prognosis for recovery.
- (c) The nature and scope of limitations and/or work restrictions.
- (d) A statement regarding any required workplace accommodations, mobility aids or medical devices.
- (e) A statement that the employee can safely perform the duties of the temporary modified-duty assignment.

The Bureau Commander will make a recommendation through the chain of command to the Chief of Police regarding temporary modified-duty assignments that may be available based on the needs of the Department and the limitations of the employee. The Chief of Police or the authorized designee shall confer with the Personnel and Training or the City Attorney as appropriate.

Requests for a temporary modified-duty assignment of 20 hours or less per week may be approved and facilitated by the Watch Commander or Bureau Commander, with notice to the Chief of Police.

1025.4.1 MODIFIED-DUTY SCHEDULES

The schedules of employees assigned to modified duty may be adjusted to suit medical appointments or Department needs at the discretion of the Bureau Commander.

The employee and his/her supervisors should be informed in writing of the schedule, assignment and limitations and restrictions as determined by the employee's health care provider.

1025.4.2 ACCOUNTABILITY

The employee's supervisor shall coordinate efforts to ensure proper time accountability and shall complete and process a change of shift/assignment form.

- (a) Employees on modified duty are responsible for coordinating required doctor visits and physical therapy appointments in advance with their supervisor to appropriately account for any duty time taken. Doctor visits and appointments for treatment of injuries or illnesses that are not work related shall be arranged during off-duty time or otherwise charged to the employee's sick leave.
- (b) Employees shall promptly submit a status report for each visit to their treating health care provider and shall immediately notify their supervisor of any change in restrictions or limitations as determined by their health care provider. An employee assigned to a modified-duty assignment shall provide a duty status report to their supervisor no less than once every 30 days while the employee is on modified duty.
- (c) Supervisors shall keep the Bureau Commander apprised of the employee's status and ability to perform the modified-duty assignment. Modified-duty assignments that

Culver City Police Department

Culver City PD Policy Manual

Temporary Modified-Duty Assignments

extend beyond 60 days will require a written status report and a request for an extension to the Bureau Commander with an update of the employee's current status and anticipated date of return to regular duty. Extensions require approval of the Chief of Police.

- (d) When it is determined that an employee on modified duty will return to regular duty, the supervisor shall notify the Bureau Commander and complete and process a change of shift/assignment form. All training and certification necessary for return to duty shall be reviewed and updated as necessary.

1025.4.3 MEDICAL EXAMINATIONS

The Department reserves the right to require, prior to returning to full-duty status, a fitness-for-duty examination of any employee assigned to a modified-duty assignment or of any employee having been on such assignment. Such examinations shall be at the expense of the Department.

Prior to returning to full-duty status, employees shall be required to provide a statement signed by their health care provider indicating that they are medically cleared to perform the basic and essential job functions of their assignment without restriction or limitation.

1025.5 ACCOUNTABILITY

Written notification of assignments, work schedules and any restrictions should be provided to employees assigned to temporary modified-duty assignments and their supervisors. Those assignments and schedules may be adjusted to accommodate department operations and the employee's medical appointments, as mutually agreed upon with the Bureau Commander.

1025.5.1 EMPLOYEE RESPONSIBILITIES

The responsibilities of employees assigned to temporary modified duty shall include, but not be limited to:

- (a) Communicating and coordinating any required medical and physical therapy appointments in advance with their supervisors.
- (b) Promptly notifying their supervisors of any change in restrictions or limitations after each appointment with their treating medical professionals.
- (c) Communicating a status update to their supervisors no less than once every 30 days while assigned to temporary modified duty.
- (d) Submitting a written status report to the Bureau Commander that contains a status update and anticipated date of return to full-duty when a temporary modified-duty assignment extends beyond 60 days.

1025.5.2 SUPERVISOR RESPONSIBILITIES

The employee's immediate supervisor shall monitor and manage the work schedule of those assigned to temporary modified duty.

The responsibilities of supervisors shall include, but not be limited to:

Culver City Police Department

Culver City PD Policy Manual

Temporary Modified-Duty Assignments

- (a) Periodically apprising the Bureau Commander of the status and performance of employees assigned to temporary modified duty.
- (b) Notifying the Bureau Commander and ensuring that the required documentation facilitating a return to full duty is received from the employee.
- (c) Ensuring that employees returning to full duty have completed any required training and certification.

1025.6 MEDICAL EXAMINATIONS

Prior to returning to full-duty status, employees shall be required to provide certification from their treating medical professionals stating that they are medically cleared to perform the essential functions of their jobs without restrictions or limitations.

The Department may require a fitness-for-duty examination prior to returning an employee to full-duty status, in accordance with the Fitness for Duty Policy.

1025.7 PREGNANCY

If an employee is temporarily unable to perform regular duties due to a pregnancy, childbirth, or a related medical condition, the employee will be treated the same as any other temporarily disabled employee (42 USC § 2000e(k)). A pregnant employee shall not be involuntarily transferred to a temporary modified-duty assignment. Nothing in this policy limits a pregnant employee's right to a temporary modified-duty assignment if required under Government Code § 12945.

If notified by an employee or the employee's representative regarding limitations related to pregnancy, childbirth, or related medical conditions, the Department should make reasonable efforts to provide an accommodation for the employee in accordance with federal and state law. The accommodation should be provided without unnecessary delay, as appropriate (42 USC § 2000gg-1; 29 CFR 1636.3; 29 CFR 1636.4; Government Code § 12945).

1025.7.1 NOTIFICATION

Pregnant employees should notify their immediate supervisors as soon as practicable and provide a statement from their medical providers identifying any pregnancy-related job restrictions or limitations. If at any point during the pregnancy it becomes necessary for the employee to take a leave of absence, such leave shall be granted in accordance with the City's personnel rules and regulations regarding family and medical care leave.

1025.8 PROBATIONARY EMPLOYEES

Probationary employees who are assigned to a temporary modified-duty assignment may have their probation extended by a period of time equal to their assignment to temporary modified duty.

1025.9 MAINTENANCE OF CERTIFICATION AND TRAINING

Employees assigned to temporary modified duty shall maintain all certification, training and qualifications appropriate to both their regular and temporary duties, provided that the certification, training or qualifications are not in conflict with any medical limitations or restrictions. Employees

Culver City Police Department

Culver City PD Policy Manual

Temporary Modified-Duty Assignments

who are assigned to temporary modified duty shall inform their supervisors of any inability to maintain any certification, training or qualifications.

Performance History Audits

Employee Speech, Expression and Social Networking

1026.1 PURPOSE AND SCOPE

This policy is intended to address issues associated with employee use of social networking sites and to provide guidelines for the regulation and balancing of employee speech and expression with the needs of the Department.

Nothing in this policy is intended to prohibit or infringe upon any communication, speech or expression that is protected or privileged under law. This includes speech and expression protected under state or federal constitutions as well as labor or other applicable laws. For example, this policy does not limit an employee from speaking as a private citizen, including acting as an authorized member of a recognized bargaining unit or officer associations, about matters of public concern, such as misconduct or corruption.

Employees are encouraged to consult with their supervisor regarding any questions arising from the application or potential application of this policy.

1026.1.1 APPLICABILITY

This policy applies to all forms of communication including but not limited to film, video, print media, public or private speech, use of all internet services, including the World Wide Web, e-mail, file transfer, remote computer access, news services, social networking, social media, instant messaging, blogs, forums, video, and other file-sharing sites.

1026.2 POLICY

Public employees occupy a trusted position in the community, and thus, their statements have the potential to contravene the policies and performance of this department. Due to the nature of the work and influence associated with the law enforcement profession, it is necessary that employees of this department be subject to certain reasonable limitations on their speech and expression. To achieve its mission and efficiently provide service to the public, the Culver City Police Department will carefully balance the individual employee's rights against the Department's needs and interests when exercising a reasonable degree of control over its employees' speech and expression.

1026.3 SAFETY

Employees should consider carefully the implications of their speech or any other form of expression when using the internet. Speech and expression that may negatively affect the safety of the Culver City Police Department employees, such as posting personal information in a public forum, can result in compromising an employee's home address or family ties. Employees should therefore not disseminate or post any information on any forum or medium that could reasonably be anticipated to compromise the safety of any employee, an employee's family, or associates. Examples of the type of information that could reasonably be expected to compromise safety include:

Culver City Police Department

Culver City PD Policy Manual

Employee Speech, Expression and Social Networking

- Disclosing a photograph and name or address of an officer who is working undercover.
- Disclosing the address of a fellow officer.
- Otherwise disclosing where another officer can be located off-duty.

1026.4 PROHIBITED SPEECH, EXPRESSION, AND CONDUCT

To meet the department's safety, performance, and public-trust needs, the following are prohibited unless the speech is otherwise protected (for example, an employee speaking as a private citizen, including acting as an authorized member of a recognized bargaining unit or officer associations, on a matter of public concern):

- (a) Speech or expression made pursuant to an official duty that tends to compromise or damage the mission, function, reputation, or professionalism of the Culver City Police Department or its employees.
- (b) Speech or expression that, while not made pursuant to an official duty, is significantly linked to, or related to, the Culver City Police Department and tends to compromise or damage the mission, function, reputation, or professionalism of the Culver City Police Department or its employees. Examples may include:
 1. Statements that indicate disregard for the law or the state or U.S. Constitution.
 2. Expression that demonstrates support for criminal activity.
 3. Participating in sexually explicit photographs or videos for compensation or distribution.
- (c) Speech or expression that could reasonably be foreseen as having a negative impact on the credibility of the employee as a witness. For example, posting statements or expressions to a website that glorify or endorse dishonesty, unlawful discrimination, or illegal behavior.
- (d) Speech or expression of any form that could reasonably be foreseen as having a negative impact on the safety of the employees of the Department. For example, a statement on a blog that provides specific details as to how and when prisoner transportations are made could reasonably be foreseen as potentially jeopardizing employees by informing criminals of details that could facilitate an escape or attempted escape.
- (e) Speech or expression that is contrary to the canons of the Law Enforcement Code of Ethics as adopted by the Culver City Police Department.
- (f) Use or disclosure, through whatever means, of any information, photograph, video, or other recording obtained or accessible as a result of employment with the Department for financial or personal gain, or any disclosure of such materials without the express authorization of the Chief of Police or the authorized designee.
- (g) Posting, transmitting, or disseminating any photographs, video or audio recordings, likenesses or images of department logos, emblems, uniforms, badges, patches, marked vehicles, equipment, or other material that specifically identifies the Culver City Police Department on any personal or social networking or other website or web page, without the express authorization of the Chief of Police.

Culver City Police Department

Culver City PD Policy Manual

Employee Speech, Expression and Social Networking

Employees must take reasonable and prompt action to remove any content, including content posted by others, that is in violation of this policy from any web page or website maintained by the employee (e.g., social or personal website).

1026.4.1 THIRD-PARTY CONTENT

Employees should take reasonable and prompt action to remove content from any web page or website maintained by the employee (e.g., social or personal website), including content posted by others, that is in violation of this policy. This includes inappropriate or prohibited third-party content that is observed by the employee or identified by other means, including but not limited to other city employees, department supervision, or members of the public.

Employees shall not participate in any communication or behavior that supports, affirms, endorses, validates, promotes, or advances prohibited or inappropriate third-party content, including but not limited to commenting, sharing, re-posting, tagging, or “Likes.”

1026.4.2 UNAUTHORIZED ENDORSEMENTS AND ADVERTISEMENTS

While employees are not restricted from engaging in the following activities as private citizens or as authorized members of a recognized bargaining unit or officer associations, employees may not represent the Culver City Police Department or identify themselves in any way that could be reasonably perceived as representing the Culver City Police Department in order to do any of the following, unless specifically authorized by the Chief of Police (Government Code § 3206; Government Code § 3302):

- (a) Endorse, support, oppose or contradict any political campaign or initiative.
- (b) Endorse, support, oppose or contradict any social issue, cause or religion.
- (c) Endorse, support or oppose any product, service, company or other commercial entity.
- (d) Appear in any commercial, social or nonprofit publication or any motion picture, film, video, public broadcast or on any website.

Additionally, when it can reasonably be construed that an employee, acting in his/her individual capacity or through an outside group or organization (e.g., bargaining group or officer associations), is affiliated with this department, the employee shall give a specific disclaiming statement that any such speech or expression is not representative of the Culver City Police Department.

Employees retain their right to vote as they choose, to support candidates of their choice and to express their opinions as private citizens, including as authorized members of a recognized bargaining unit or officer associations, on political subjects and candidates at all times while off-duty.

However, employees may not use their official authority or influence to interfere with or affect the result of an election or a nomination for office. Employees are also prohibited from directly or indirectly using their official authority to coerce, command or advise another employee to pay, lend

Culver City Police Department

Culver City PD Policy Manual

Employee Speech, Expression and Social Networking

or contribute anything of value to a party, committee, organization, agency or person for political purposes (5 USC § 1502).

1026.5 PRIVACY EXPECTATION

Employees forfeit any expectation of privacy with regard to e-mails, texts, or anything published or maintained through file-sharing software or any internet site (e.g., Facebook) that is accessed, transmitted, received, or reviewed on any department technology system (see the Information Technology Use Policy for additional guidance).

The Department shall not require an employee to disclose a personal user name or password for accessing personal social media or to open a personal social website; however, the Department may request access when it is reasonably believed to be relevant to the investigation of allegations of work-related misconduct (Labor Code § 980).

1026.6 CONSIDERATIONS

In determining whether to grant authorization of any speech or conduct that is prohibited under this policy, the factors that the Chief of Police or authorized designee should consider include:

- (a) Whether the speech or conduct would negatively affect the efficiency of delivering public services.
- (b) Whether the speech or conduct would be contrary to the good order of the Department or the efficiency or morale of its members.
- (c) Whether the speech or conduct would reflect unfavorably upon the Department.
- (d) Whether the speech or conduct would negatively affect the member's appearance of impartiality in the performance of his/her duties.
- (e) Whether similar speech or conduct has been previously authorized.
- (f) Whether the speech or conduct may be protected and outweighs any interest of the Department.

1026.7 TRAINING

Subject to available resources, the Department should provide training regarding employee speech and the use of social networking to all members of the Department.

Personal Appearance Standards

1027.1 PURPOSE AND SCOPE

In order to project uniformity and neutrality toward the public and other members of the department, employees shall maintain their personal hygiene and appearance to project a professional image appropriate for this department and for their assignment.

1027.2 GROOMING STANDARDS

Unless otherwise stated and because deviations from these standards could present officer safety issues, the following appearance standards shall apply to all employees, except those whose current assignment would deem them not appropriate, and where the Chief of Police has granted exception.

1027.2.1 HAIR

Hairstyles of all members shall be neat in appearance. For male sworn members, hair must not extend below the top edge of the uniform collar while assuming a normal stance.

For female sworn members, hair must be no longer than the horizontal level of the bottom of the uniform patch when the employee is standing erect, worn up or in a tightly wrapped braid or ponytail.

1027.2.2 MUSTACHES

A short and neatly trimmed mustache may be worn. Mustaches shall not extend below the corners of the mouth or beyond the natural hairline of the upper lip.

1027.2.3 SIDEBURNS

Sideburns shall not extend below the bottom of the outer ear opening (the top of the earlobes) and shall be trimmed and neat.

1027.2.4 FACIAL HAIR

Facial hair other than sideburns, mustaches and eyebrows shall not be worn, unless authorized by the Chief of Police or his or her designee.

1027.2.5 FINGERNAILS

Fingernails extending beyond the tip of the finger can pose a safety hazard to officers or others. For this reason, fingernails shall be trimmed so that no point of the nail extends beyond the tip of the finger.

1027.2.6 JEWELRY AND ACCESSORIES

No jewelry or personal ornaments shall be worn by officers on any part of the uniform or equipment, except those authorized within this manual. Jewelry, if worn around the neck, shall not be visible above the shirt collar.

Culver City Police Department

Culver City PD Policy Manual

Personal Appearance Standards

Earrings shall not be worn by uniformed sworn members, detectives or special assignment personnel without permission of the Chief of Police or his/her designee. Only one ring may be worn on each hand of the employee while on-duty.

1027.3 TATTOOS AND BODY ART

Any member of the Department hired after April 30, 2005, shall not have any tattoos, brands and/or body ornamentation (i.e. body piercings) visible during the performance of duties in the course and scope of employment. However, female officers may wear a single pair of stud-style earrings and non-sworn female employees may wear a single pair of earrings.

Employees hired prior to April 30, 2005, that have visible tattoos, brands and/or body ornamentation (i.e. body piercings) will be subject to the following conditions:

- (a) Tattoos, brands and/or body ornamentation (i.e. body piercings) are prohibited on the head, neck, hands and face. Body piercings that are visible are prohibited with the exception of female officers who may wear a single pair of stud-style earrings. Non-sworn female employees may wear a single pair of earrings.
- (b) Tattoos and/or brands shall not refer to or depict sex/sexual acts, organs, conduct, preferences/intolerance, obscene or graphic language, discrimination or intolerance against any race, religion, gender or national origin or infer affiliation with group(s) advocating such beliefs. Symbols, references, icons, logos or letters commonly associated with street gangs or indicating gang affiliation are also prohibited.
- (c) Any employee hired before April 30, 2005, that acquires an additional tattoo will be held to the standard of employees hired after April 30, 2005.

In all instances, tattoos, body art and/or objects utilized in body piercing shall not be displayed to other City and Department employees while on or in properties and/or facilities owned, operated or under the dominion and control of the City/Department, where the content of the tattoo, body art, and/or piercing may be perceived by a reasonable City/Department employee as indicative of harassment or discrimination based on race, religion, creed, color, national origin, ancestry, physical handicap, medical condition, marital status, sex, or age or of otherwise creating a Department environment having a negative impact upon the efficient operation of the employee or of the City/Department. (For example, although a tattoo of a Nazi swastika may be implanted on a body part in such a manner that it is concealable during performance in the course and scope of employment, the display of that same tattoo while disrobed in a locker room, may be reasonably perceived by a fellow employee as being a violation of this policy.)

Exceptions to this policy can be made by the Chief of Police on a case-by-case basis (i.e. undercover work).

1027.3.1 TATTOOS AND BODY ART CONCEALMENT

For on-duty field personnel, visible tattoos, brands, and/or body ornamentation that do not conform to department policy detailed in section 1027.3 may be concealed in the following manner:

- **The long sleeve Class A shirt** - The long sleeve of the shirt must conceal the tattoos, brands, and/or body ornamentation completely.

Culver City Police Department

Culver City PD Policy Manual

Personal Appearance Standards

- **The short sleeve Class B shirt with Compression Sleeve** -The short sleeve Class B shirt may be worn using a black compression sleeve for concealment of unauthorized tattoos and/or body ornamentation. The compression sleeve shall be made of form-fitting polyester, nylon, or similar material. The compression sleeve must:
 - Be black in color with no visible logos, patterns, or other visible designs.
 - Conceal the tattoos, brands, and/or body ornamentation completely.
 - Be worn on both arms (regardless of whether tattoos or other body ornamentations are present on both arms).

1027.4 BODY PIERCING OR ALTERATION

Body piercing or alteration to any area of the body visible in any authorized uniform or attire that is a deviation from normal anatomical features and which is not medically required is prohibited. Such body alteration includes, but is not limited to:

- (a) Tongue splitting or piercing.
- (b) The complete or transdermal implantation of any material other than hair replacement.
- (c) Abnormal shaping of the ears, eyes, nose or teeth
- (d) Branding or scarification.

1027.5 EXEMPTIONS

Members who seek cultural (e.g., culturally protected hairstyles) or other exemptions to this policy that are protected by law should generally be accommodated (Government Code § 12926). A member with an exemption may be ineligible for an assignment if the individual accommodation presents a security or safety risk. The Chief of Police should be advised any time a request for such an accommodation is denied or when a member with a cultural or other exemption is denied an assignment based on a safety or security risk.

1027.6 NO-SHAVE NOVEMBER

During the month of November, Department personnel will be permitted to forgo shaving in order to raise awareness for Cancer. The following rules apply:

Goatees - Must be accompanied with a mustache and maintained in a professional manner. Goatees should be neat, trimmed, and complete around the upper lip, chin, and jawline. Goatees must be maintained at an equal length that does not exceed one half inch. Goatees should not interfere with the wearing of the uniform, headgear, or other safety equipment. Goatees are also not permitted below the Adam's apple or on the neck.

Beards - Must be accompanied with a mustache and maintained in a professional manner. Beards should be neat, trimmed, complete around the jawline/cheeks of the face and maintained at an equal length that does not exceed one-half inch. Beards should not interfere with the wearing of the uniform, headgear, or other safety equipment. Beards shall not extend in length beyond the normal contours of the face and shall not be permitted below the Adam's apple or on the neck.

Culver City Police Department

Culver City PD Policy Manual

Personal Appearance Standards

Employees opting to wear a goatee or beard must keep shaving materials accessible in case of emergencies or circumstances, as deemed by the Chief of Police, where facial hair cannot be retained (ie. when wearing a Class A or Honor Guard uniform).

Anti-Retaliation

1028.1 PURPOSE AND SCOPE

This policy prohibits retaliation against members who identify workplace issues, such as fraud, waste, abuse of authority, gross mismanagement or any inappropriate conduct or practices, including violations that may pose a threat to the health, safety or well-being of members.

This policy does not prohibit actions taken for nondiscriminatory or non-retaliatory reasons, such as discipline for cause.

These guidelines are intended to supplement and not limit members' access to other applicable remedies. Nothing in this policy shall diminish the rights or remedies of a member pursuant to any applicable federal law, provision of the U.S. Constitution, law, ordinance or memorandum of understanding.

1028.2 POLICY

The Culver City Police Department has a zero tolerance for retaliation and is committed to taking reasonable steps to protect from retaliation members who, in good faith, engage in permitted behavior or who report or participate in the reporting or investigation of workplace issues. All complaints of retaliation will be taken seriously and will be promptly and appropriately investigated.

1028.3 RETALIATION PROHIBITED

No member may retaliate against any person for engaging in lawful or otherwise permitted behavior; for opposing a practice believed to be unlawful, unethical, discriminatory or retaliatory; for reporting or making a complaint under this policy; or for participating in any investigation related to a complaint under this or any other policy.

Retaliation includes any adverse action or conduct, including but not limited to:

- Refusing to hire or denying a promotion.
- Extending the probationary period.
- Unjustified reassignment of duties or change of work schedule.
- Real or implied threats or other forms of intimidation to dissuade the reporting of wrongdoing or filing of a complaint, or as a consequence of having reported or participated in protected activity.
- Taking unwarranted disciplinary action.
- Spreading rumors about the person filing the complaint or about the alleged wrongdoing.
- Shunning or unreasonably avoiding a person because he/she has engaged in protected activity.

Culver City Police Department

Culver City PD Policy Manual

Anti-Retaliation

1028.3.1 RETALIATION PROHIBITED FOR REPORTING VIOLATIONS

An officer shall not be retaliated against for reporting a suspected violation of a law or regulation of another officer to a supervisor or other person in the Department who has the authority to investigate the violation (Government Code § 7286(b)).

1028.4 COMPLAINTS OF RETALIATION

Any member who feels he/she has been retaliated against in violation of this policy should promptly report the matter to any supervisor, command staff member, Chief of Police or the City Personnel and Training Lieutenant.

Members shall act in good faith, not engage in unwarranted reporting of trivial or minor deviations or transgressions, and make reasonable efforts to verify facts before making any complaint in order to avoid baseless allegations. Members shall not report or state an intention to report information or an allegation knowing it to be false, with willful or reckless disregard for the truth or falsity of the information or otherwise act in bad faith.

Investigations are generally more effective when the identity of the reporting member is known, thereby allowing investigators to obtain additional information from the reporting member. However, complaints may be made anonymously. All reasonable efforts shall be made to protect the reporting member's identity. However, confidential information may be disclosed to the extent required by law or to the degree necessary to conduct an adequate investigation and make a determination regarding a complaint. In some situations, the investigative process may not be complete unless the source of the information and a statement by the member is part of the investigative process.

1028.5 SUPERVISOR RESPONSIBILITIES

Supervisors are expected to remain familiar with this policy and ensure that members under their command are aware of its provisions.

The responsibilities of supervisors include, but are not limited to:

- (a) Ensuring complaints of retaliation are investigated as provided in the Personnel Complaints Policy.
- (b) Receiving all complaints in a fair and impartial manner.
- (c) Documenting the complaint and any steps taken to resolve the problem.
- (d) Acknowledging receipt of the complaint, notifying the Chief of Police via the chain of command and explaining to the member how the complaint will be handled.
- (e) Taking appropriate and reasonable steps to mitigate any further violations of this policy.
- (f) Monitoring the work environment to ensure that any member making a complaint is not subjected to further retaliation.
- (g) Periodic follow-up with the complainant to ensure that retaliation is not continuing.

Culver City Police Department

Culver City PD Policy Manual

Anti-Retaliation

- (h) Not interfering with or denying the right of a member to make any complaint.
- (i) Taking reasonable steps to accommodate requests for assignment or schedule changes made by a member who may be the target of retaliation if it would likely mitigate the potential for further violations of this policy.

1028.6 COMMAND STAFF RESPONSIBILITIES

The Chief of Police should communicate to all supervisors the prohibition against retaliation.

Command staff shall treat all complaints as serious matters and shall ensure that prompt actions take place, including but not limited to:

- (a) Communicating to all members the prohibition against retaliation.
- (b) The timely review of complaint investigations.
- (c) Remediation of any inappropriate conduct or condition and instituting measures to eliminate or minimize the likelihood of recurrence.
- (d) The timely communication of the outcome to the complainant.

1028.7 WHISTLE-BLOWING

California law protects members who (Labor Code § 1102.5; Government Code § 53296 et seq.):

- (a) Report a violation of a state or federal statute or regulation to a government or law enforcement agency, including the member's supervisor or any other member with the authority to investigate the reported violation.
- (b) Provide information or testify before a public body if the member has reasonable cause to believe a violation of law occurred.
- (c) Refuse to participate in an activity that would result in a violation of a state or federal statute or regulation.
- (d) File a complaint with a local agency about gross mismanagement or a significant waste of funds, abuse of authority, or a substantial and specific danger to public health or safety. Members shall exhaust all available administrative remedies prior to filing a formal complaint.
- (e) Are family members of a person who has engaged in any protected acts described above.

Members are encouraged to report any legal violations through the chain of command (Labor Code § 1102.5).

Members who believe they have been the subject of retaliation for engaging in such protected behaviors should promptly report it to a supervisor. Supervisors should refer the complaint to the Professional Standards Unit for investigation pursuant to the Personnel Complaints Policy.

Culver City Police Department

Culver City PD Policy Manual

Anti-Retaliation

1028.7.1 DISPLAY OF WHISTLE-BLOWER LAWS

The Department shall display a notice to members regarding their rights and responsibilities under the whistle-blower laws, including the whistle-blower hotline maintained by the Office of the Attorney General (Labor Code § 1102.8).

1028.8 RECORDS RETENTION AND RELEASE

The Records Supervisor shall ensure that documentation of investigations is maintained in accordance with the established records retention schedules.

1028.9 TRAINING

The policy should be reviewed with each new member.

All members should receive periodic refresher training on the requirements of this policy.

Line-of-Duty Deaths

1029.1 PURPOSE AND SCOPE

The purpose of this policy is to provide guidance to members of the Culver City Police Department in the event of the death of a member occurring in the line of duty and to direct the Department in providing proper support for the member's survivors.

The Chief of Police may also apply some or all of this policy for a non-line-of-duty member death, or in situations where members are injured in the line of duty and the injuries are life-threatening.

1029.1.1 DEFINITIONS

Definitions related to this policy include:

Line-of-duty death - The death of an officer during the course of performing law enforcement-related functions while on- or off-duty, or a professional staff member during the course of performing assigned duties.

For an officer, a line-of-duty death includes death that is the direct and proximate result of a personal injury sustained in the line of duty (34 USC § 10281).

Survivors - Immediate family members of the deceased member, which can include spouse, children, parents, other next of kin, or significant others. The determination of who should be considered a survivor for purposes of this policy should be made on a case-by-case basis given the individual's relationship with the member and whether the individual was previously designated by the deceased member.

1029.2 POLICY

It is the policy of the Culver City Police Department to make appropriate notifications and to provide assistance and support to survivors and coworkers of a member who dies in the line of duty.

It is also the policy of this department to respect the requests of the survivors when they conflict with these guidelines, as appropriate.

1029.3 INITIAL ACTIONS BY COMMAND STAFF

- (a) Upon learning of a line-of-duty death, the deceased member's supervisor should provide all reasonably available information to the Watch Commander and Southbay RCC.
 1. Communication of information concerning the member and the incident should be restricted to secure networks to avoid interception by the media or others (see the Public Information Officer section of this policy).
- (b) The Watch Commander should ensure that notifications are made in accordance with the Officer-Involved Shootings and Deaths and Major Incident Notification policies as applicable.

Culver City Police Department

Culver City PD Policy Manual

Line-of-Duty Deaths

- (c) If the member has been transported to the hospital, the Watch Commander or the authorized designee should respond to the hospital to assume temporary responsibilities as the Hospital Liaison.
- (d) The Chief of Police or the authorized designee should assign members to handle survivor notifications and assign members to the roles of Hospital Liaison (to relieve the temporary Hospital Liaison) and the Department Liaison as soon as practicable (see the Notifying Survivors section and the Department Liaison and Hospital Liaison subsections in this policy).

1029.4 NOTIFYING SURVIVORS

Survivors should be notified as soon as possible in order to avoid the survivors hearing about the incident in other ways.

The Chief of Police or the authorized designee should review the deceased member's emergency contact information and make accommodations to respect the member's wishes and instructions specific to notifying survivors. However, notification should not be excessively delayed because of attempts to assemble a notification team in accordance with the member's wishes.

The Chief of Police, Watch Commander, or the authorized designee should select at least two members to conduct notification of survivors, one of which may be the Department chaplain.

Notifying members should:

- (a) Make notifications in a direct and compassionate manner, communicating as many facts of the incident as possible, including the current location of the member. Information that is not verified should not be provided until an investigation has been completed.
- (b) Determine the method of notifying surviving children by consulting with other survivors and taking into account factors such as the child's age, maturity, and current location (e.g., small children at home, children in school).
- (c) Plan for concerns such as known health concerns of survivors or language barriers.
- (d) Offer to transport survivors to the hospital, if appropriate. Survivors should be transported in department vehicles. Notifying members shall inform the Hospital Liaison over a secure network that the survivors are on their way to the hospital. Notifying members should remain at the hospital while the survivors are present.
- (e) When survivors are not at their residences or known places of employment, actively seek information and follow leads from neighbors, other law enforcement, postal authorities, and other sources of information in order to accomplish notification in as timely a fashion as possible. Notifying members shall not disclose the reason for their contact other than a family emergency.
- (f) If making notification at a survivor's workplace, ask a workplace supervisor for the use of a quiet, private room to meet with the survivor. Members shall not inform the workplace supervisor of the purpose of their visit other than to indicate that it is a family emergency.

Culver City Police Department

Culver City PD Policy Manual

Line-of-Duty Deaths

- (g) Offer to call other survivors, friends, or clergy to support the survivors and to avoid leaving survivors alone after notification.
- (h) Assist the survivors with meeting child care or other immediate needs.
- (i) Provide other assistance to survivors and take reasonable measures to accommodate their needs, wishes, and desires. Care should be taken not to make promises or commitments to survivors that cannot be met.
- (j) Inform the survivors of the name and phone number of the Survivor Support Liaison (see the Survivor Support Liaison section of this policy), if known, and the Department Liaison.
- (k) Provide their contact information to the survivors before departing.
- (l) Document the survivors' names and contact information, as well as the time and location of notification. This information should be forwarded to the Department Liaison.
- (m) Inform the Chief of Police or the authorized designee once survivor notifications have been made so that other Culver City Police Department members may be apprised that survivor notifications are complete.

1029.4.1 OUT-OF-AREA NOTIFICATIONS

The Department Liaison should request assistance from law enforcement agencies in appropriate jurisdictions for in-person notification to survivors who are out of the area.

- (a) The Department Liaison should contact the appropriate jurisdiction using a secure network and provide the assisting agency with the name and telephone number of the department member that the survivors can call for more information following the notification by the assisting agency.
- (b) The Department Liaison may assist in making transportation arrangements for the member's survivors, but will not obligate the Department to pay travel expenses without the authorization of the Chief of Police.

1029.5 NOTIFYING DEPARTMENT MEMBERS

Supervisors or members designated by the Chief of Police are responsible for notifying department members of the line-of-duty death as soon as possible after the survivor notification is made. Notifications and related information should be communicated in person or using secure networks and should not be transmitted over the radio.

Notifications should be made in person and as promptly as possible to all members on-duty at the time of the incident. Members reporting for subsequent shifts within a short amount of time should be notified in person at the beginning of their shifts. Members reporting for duty from their residences should be instructed to contact their supervisors as soon as practicable. Those members who are working later shifts or are on days off should be notified by phone as soon as practicable.

Culver City Police Department

Culver City PD Policy Manual

Line-of-Duty Deaths

Members having a close bond with the deceased member should be notified of the incident in person. Supervisors should consider assistance (e.g., peer support, modifying work schedules, approving sick leave) for members who are especially affected by the incident.

Supervisors should direct members not to disclose any information outside the Department regarding the deceased member or the incident.

1029.6 LIAISONS AND COORDINATORS

The Chief of Police or the authorized designee should select members to serve as liaisons and coordinators to handle responsibilities related to a line-of-duty death, including but not limited to:

- (a) Department Liaison.
- (b) Hospital Liaison.
- (c) Survivor Support Liaison.
- (d) Wellness Support Liaison.
- (e) Funeral Liaison.
- (f) Mutual aid coordinator.
- (g) Benefits Liaison.
- (h) Finance coordinator.

Liaisons and coordinators will be directed by the Department Liaison and should be given sufficient duty time to complete their assignments.

Members may be assigned responsibilities of more than one liaison or coordinator position depending on available department resources. The Department Liaison may assign separate liaisons and coordinators to accommodate multiple family units, if needed. The Department should consider seeking assistance from surrounding law enforcement agencies to fill liaison and coordinator positions, as appropriate.

1029.6.1 DEPARTMENT LIAISON

The Department Liaison should be a Bureau Commander or of sufficient rank to effectively coordinate department resources, and should serve as a facilitator between the deceased member's survivors and the Department. The Department Liaison reports directly to the Chief of Police. The Department Liaison's responsibilities include but are not limited to:

- (a) Directing the other liaisons and coordinators in fulfilling survivors' needs and requests. Consideration should be given to organizing the effort using the National Incident Management System.
- (b) Establishing contact with survivors within 24 hours of the incident and providing them contact information.
- (c) Advising survivors of the other liaison and coordinator positions and their roles and responsibilities.

Culver City Police Department

Culver City PD Policy Manual

Line-of-Duty Deaths

- (d) Identifying locations that will accommodate a law enforcement funeral and presenting the options to the appropriate survivors, who will select the location.
- (e) Coordinating all official law enforcement notifications and arrangements.
- (f) Making necessary contacts for authorization to display flags at half-staff.
- (g) Reminding department members of appropriate information-sharing restrictions regarding the release of information that could undermine future legal proceedings.
- (h) Coordinating security checks of the member's residence as necessary and reasonable.
- (i) Serving as a liaison with visiting law enforcement agencies during memorial and funeral services.

1029.6.2 HOSPITAL LIAISON

The Hospital Liaison should work with hospital personnel to:

- (a) Establish a command post or incident command system, as appropriate, to facilitate management of the situation and its impact on hospital operations (e.g., influx of people, parking).
- (b) Arrange for appropriate and separate waiting areas for:
 - 1. The survivors and others whose presence is requested by the survivors.
 - 2. Department members and friends of the deceased member.
 - 3. Media personnel.
- (c) Ensure, as practicable, that any suspects who are in the hospital and their families or friends are not in proximity to the member's survivors or Culver City Police Department members (except for members who may be guarding a suspect).
- (d) Arrange for survivors to receive timely updates regarding the member before information is released to others.
- (e) Arrange for survivors to have private time with the member, if requested.
 - 1. The Hospital Liaison or hospital personnel may need to explain the condition of the member to the survivors to prepare them accordingly.
 - 2. The Hospital Liaison should accompany the survivors into the room, if requested.
- (f) Stay with survivors and provide them with other assistance as needed at the hospital.
- (g) If applicable, explain to the survivors why an autopsy may be needed.
- (h) Make arrangements for hospital bills to be directed to the Department, that the survivors are not asked to sign as guarantor of payment for any hospital treatment, and that the member's residence address, insurance information, and next of kin are not included on hospital paperwork.

Other responsibilities of the Hospital Liaison include but are not limited to:

- Arranging transportation for the survivors back to their residence.

Culver City Police Department

Culver City PD Policy Manual

Line-of-Duty Deaths

- Working with investigators to gather and preserve the deceased member's equipment and other items that may be of evidentiary value.
- Documenting their actions at the conclusion of duties.

1029.6.3 SURVIVOR SUPPORT LIAISON

The Survivor Support Liaison should work with the Department Liaison to fulfill the immediate needs and requests of the survivors of any member who has died in the line of duty, and serve as the long-term department contact for survivors.

The Survivor Support Liaison should be selected by the deceased member's Bureau Commander. The following should be considered when selecting the Survivor Support Liaison:

- The liaison should be an individual the survivors know and with whom they are comfortable working.
- The selection may be made from names recommended by the deceased member's supervisor and/or coworkers. The deceased member's partner or close friends may not be the best selections for this assignment because the emotional connection to the member or survivors may impair their ability to conduct adequate liaison duties.
- The liaison must be willing to assume the assignment with an understanding of the emotional and time demands involved.

The responsibilities of the Survivor Support Liaison include but are not limited to:

- (a) Arranging for transportation of survivors to hospitals, places of worship, funeral homes, and other locations, as appropriate.
- (b) Communicating with the Department Liaison regarding appropriate security measures for the family residence, as needed.
- (c) If requested by the survivors, providing assistance with instituting methods of screening telephone calls made to their residence after the incident.
- (d) Providing assistance with travel and lodging arrangements for out-of-town survivors.
- (e) Returning the deceased member's personal effects from the Department and the hospital to the survivors. The following should be considered when returning the personal effects:
 1. Items should not be delivered to the survivors until they are ready to receive the items.
 2. Items not retained as evidence should be delivered in a clean, unmarked box.
 3. All clothing not retained as evidence should be cleaned and made presentable (e.g., items should be free of blood or other signs of the incident).
 4. The return of some personal effects may be delayed due to ongoing investigations.
- (f) Assisting with the return of department-issued equipment that may be at the deceased member's residence.

Culver City Police Department

Culver City PD Policy Manual

Line-of-Duty Deaths

1. Unless there are safety concerns, the return of the equipment should take place after the funeral at a time and in a manner considerate of the survivors' wishes.
- (g) Working with the Wellness Support Liaison for survivors to have access to available counseling services.
- (h) Coordinating with the department's Public Information Officer (PIO) to brief the survivors on pending press releases related to the incident and to assist the survivors with media relations in accordance with their wishes (see the Public Information Officer section of this policy).
- (i) Briefing survivors on investigative processes related to the line-of-duty death, such as criminal, internal, and administrative investigations.
- (j) Informing survivors of any related criminal proceedings and accompanying them to such proceedings.
- (k) Introducing survivors to prosecutors, victim's assistance personnel, and other involved personnel as appropriate.
- (l) Maintaining long-term contact with survivors and taking measures to sustain a supportive relationship (e.g., follow-up visits, phone calls, cards on special occasions, special support during holidays).
- (m) Inviting survivors to department activities, memorial services (e.g., as applicable, the Annual Candlelight Vigil at the National Law Enforcement Officers Memorial), or other functions as appropriate.

Survivor Support Liaisons providing services after an incident resulting in multiple members being killed should coordinate with and support each other through conference calls or meetings as necessary.

The Department recognizes that the duties of a Survivor Support Liaison will often affect regular assignments over many years, and is committed to supporting members in the assignment.

If needed, the Survivor Support Liaison should be issued a personal communication device (PCD) owned by the Department to facilitate communications necessary to the assignment. The department-issued PCD shall be used in accordance with the Personal Communication Devices Policy.

1029.6.4 WELLNESS SUPPORT LIAISON

The Wellness Support Liaison should work with the department wellness coordinator or the authorized designee and other liaisons and coordinators to make wellness support and counseling services available to members and survivors who are impacted by a line-of-duty death. The responsibilities of the Wellness Support Liaison include but are not limited to:

- (a) Identifying members who are likely to be significantly affected by the incident and may have an increased need for wellness support and counseling services, including:
 1. Members involved in the incident.
 2. Members who witnessed the incident.

Culver City Police Department

Culver City PD Policy Manual

Line-of-Duty Deaths

3. Members who worked closely with the deceased member but were not involved in the incident.
 - (b) Making arrangements for members who were involved in or witnessed the incident to be relieved of department responsibilities until they can receive wellness support.
 - (c) Making wellness support and counseling resources (e.g., peer support, Critical Incident Stress Debriefing) available to members as soon as reasonably practicable following the line-of-duty death.
 - (d) Coordinating with the Survivor Support Liaison to inform survivors of available wellness support and counseling services and assisting with arrangements as needed.
 - (e) Following up with members and the Survivor Support Liaison in the months following the incident to determine if additional wellness support or counseling services are needed.

1029.6.5 FUNERAL LIAISON

The Funeral Liaison should work with the Department Liaison, Survivor Support Liaison, and survivors to coordinate funeral arrangements to the extent the survivors wish. The Funeral Liaison's responsibilities include but are not limited to:

- (a) Assisting survivors in working with the funeral director regarding funeral arrangements and briefing them on law enforcement funeral procedures.
- (b) Completing funeral notification to other law enforcement agencies.
- (c) Coordinating the funeral activities of the Department, including but not limited to the following:
 1. Honor Guard
 - (a) Casket watch
 - (b) Color guard
 - (c) Pallbearers
 - (d) Bell/rifle salute
 2. Bagpipers/bugler
 3. Uniform for burial
 4. Flag presentation
 5. Last radio call
- (d) Briefing the Chief of Police and command staff concerning funeral arrangements.
- (e) Assigning an officer to remain at the family home during the viewing and funeral.
- (f) Arranging for transportation of the survivors to and from the funeral home and interment site using department vehicles and drivers.
- (g) Addressing event-related logistical matters (e.g., parking, visitor overflow, public assembly areas).

Culver City Police Department

Culver City PD Policy Manual

Line-of-Duty Deaths

1029.6.6 MUTUAL AID COORDINATOR

The mutual aid coordinator should work with the Department Liaison and the Funeral Liaison to request and coordinate any assistance from outside law enforcement agencies needed for, but not limited to:

- (a) Traffic control during the deceased member's funeral.
- (b) Area coverage so that as many Culver City Police Department members can attend funeral services as possible.

The mutual aid coordinator should perform duties in accordance with the Outside Agency Assistance Policy.

Where practicable, the Chief of Police should appoint a mutual aid coordinator to identify external resources in advance of any need (e.g., regional honor guard teams, county- or state-wide resources).

1029.6.7 BENEFITS LIAISON

The Benefits Liaison should provide survivors with information concerning available benefits and will assist them in applying for benefits. Responsibilities of the Benefits Liaison include but are not limited to:

- (a) Confirming the filing of workers' compensation claims and related paperwork (see the Occupational Disease and Work-Related Injury Reporting Policy).
- (b) Researching and assisting survivors with application for federal government survivor benefits, such as those offered through the following:
 - 1. Public Safety Officers' Benefits Program, including financial assistance available through the Public Safety Officers' Educational Assistance (PSOEA) Program, as applicable (34 USC § 10281 et seq.).
 - 2. Social Security Administration.
 - 3. Department of Veterans Affairs.
- (c) Researching and assisting survivors with application for state and local government survivor benefits, such as:
 - 1. Education benefits (Education Code § 68120).
 - 2. Health benefits (Labor Code § 4856).
 - 3. Workers' compensation death benefit (Labor Code § 4702).
- (d) Researching and assisting survivors with application for other survivor benefits such as:
 - 1. Private foundation survivor benefits programs.
 - 2. Survivor scholarship programs.
- (e) Researching and informing survivors of support programs sponsored by police associations and other organizations.

Culver City Police Department

Culver City PD Policy Manual

Line-of-Duty Deaths

- (f) Documenting and informing survivors of inquiries and interest regarding public donations to the survivors.
 - 1. If requested, working with the finance coordinator to assist survivors with establishing a process for the receipt of public donations.
- (g) Providing survivors with a summary of the nature and amount of benefits applied for, including the name of a contact person at each benefit office. Printed copies of the summary and benefit application documentation should be provided to affected survivors.
- (h) Maintaining contact with the survivors and assisting with subsequent benefit questions and processes as needed.

1029.6.8 FINANCE COORDINATOR

The finance coordinator should work with the Chief of Police and the Department Liaison to manage financial matters related to the line-of-duty death. The finance coordinator's responsibilities include, but are not limited to:

- (a) Establishing methods for purchasing and monitoring costs related to the incident.
- (b) Providing information on finance-related issues, such as:
 - 1. Paying survivors' travel costs if authorized.
 - 2. Transportation costs for the deceased.
 - 3. Funeral and memorial costs.
 - 4. Related funding or accounting questions and issues.
- (c) Working with the Benefits Liaison to establish a process for the receipt of public donations to the deceased member's survivors.
- (d) Providing accounting and cost information as needed.

1029.7 PUBLIC INFORMATION OFFICER

In the event of a line-of-duty death, the department's PIO should be the department's contact point for the media. As such, the PIO should coordinate with the Department Liaison to:

- (a) Collect and maintain the most current incident information and determine what information should be released.
- (b) Instruct department members to direct any media inquiries to the PIO.
- (c) Prepare necessary press releases.
 - 1. Coordinate with other entities having media roles (e.g., outside agencies involved in the investigation or incident).
 - 2. Disseminate important public information, such as information on how the public can show support for the department and deceased member's survivors.
- (d) Arrange for community and media briefings by the Chief of Police or the authorized designee as appropriate.
- (e) Respond, or coordinate the response, to media inquiries.

Culver City Police Department

Culver City PD Policy Manual

Line-of-Duty Deaths

- (f) If requested, assist the member's survivors with media inquiries.
 - 1. Brief the survivors on handling sensitive issues such as the types of questions that reasonably could jeopardize future legal proceedings.
- (g) Release information regarding memorial services and funeral arrangements to department members, other agencies, and the media as appropriate.
- (h) If desired by the survivors, arrange for the recording of memorial and funeral services via photos and/or video.

The identity of deceased members should be withheld until the member's survivors have been notified. If the media have obtained identifying information for the deceased member prior to survivor notification, the PIO should request that the media withhold the information from release until proper notification can be made to survivors. The PIO should notify media when survivor notifications have been made.

1029.8 DEPARTMENT CHAPLAIN

The Department chaplain may serve a significant role in line-of-duty deaths. Chaplain duties may include but are not limited to:

- Assisting with survivor notifications and assisting the survivors with counseling, emotional support, or other matters, as appropriate.
- Assisting liaisons and coordinators with their assignments, as appropriate.
- Assisting department members with counseling or emotional support, as requested and appropriate.

Further information on the potential roles and responsibilities of the chaplain is in the Chaplains Policy.

1029.9 INVESTIGATION OF THE INCIDENT

The Chief of Police should make necessary assignments to conduct thorough investigations of any line-of-duty death and may choose to use the investigation process outlined in the Officer-Involved Shootings and Deaths Policy.

Investigators from other agencies may be assigned to work on any criminal investigation related to line-of-duty deaths. Partners, close friends, or personnel who worked closely with the deceased member should not have any investigative responsibilities because such relationships may impair the objectivity required for an impartial investigation of the incident.

Involved department members should be kept informed of the progress of the investigations and provide investigators with any information that may be pertinent to the investigations.

1029.10 LINE-OF-DUTY DEATH OF A LAW ENFORCEMENT ANIMAL

The Chief of Police may authorize appropriate memorial and funeral services for law enforcement animals killed in the line of duty.

Culver City Police Department

Culver City PD Policy Manual

Line-of-Duty Deaths

1029.11 NON-LINE-OF-DUTY DEATH

The Chief of Police may authorize certain support services for the death of a member not occurring in the line of duty.

Wellness Program

1030.1 PURPOSE AND SCOPE

The purpose of this policy is to provide guidance on establishing and maintaining a proactive wellness program for department members.

The wellness program is intended to be a holistic approach to a member's well-being and encompasses aspects such as physical fitness, mental health, and overall wellness.

Additional information on member wellness is provided in the:

- Chaplains Policy.
- Line-of-Duty Deaths Policy.
- Drug- and Alcohol-Free Workplace Policy.

1030.1.1 DEFINITIONS

Definitions related to this policy include:

Critical incident – An event or situation that may cause a strong emotional, cognitive, or physical reaction that has the potential to interfere with daily life.

Critical Incident Stress Debriefing (CISD) – A standardized approach using a discussion format to provide education, support, and emotional release opportunities for members involved in work-related critical incidents.

Peer support – Mental and emotional wellness support provided by peers trained to help members cope with critical incidents and certain personal or professional problems.

1030.2 POLICY

It is the policy of the Culver City Police Department to prioritize member wellness to foster fitness for duty and support a healthy quality of life for department members. The Department will maintain a wellness program that supports its members with proactive wellness resources, critical incident response, and follow-up support.

1030.3 WELLNESS COORDINATOR

The Chief of Police should appoint a trained wellness coordinator. The coordinator should report directly to the Chief of Police or the authorized designee and should collaborate with advisers (e.g., Personnel and Training, legal counsel, licensed psychotherapist, qualified health professionals), as appropriate, to fulfill the responsibilities of the position, including but not limited to:

- (a) Identifying wellness support providers (e.g., licensed psychotherapists, external peer support providers, physical therapists, dietitians, physical fitness trainers holding accredited certifications).
 1. As appropriate, selected providers should be trained and experienced in providing mental wellness support and counseling to public safety personnel.

Culver City Police Department

Culver City PD Policy Manual

Wellness Program

2. When practicable, the Department should not use the same licensed psychotherapist for both member wellness support and fitness for duty evaluations.
- (b) Developing management and operational procedures for department peer support members, such as:
1. Peer support member selection and retention.
 2. Training and applicable certification requirements.
 3. Deployment.
 4. Managing potential conflicts between peer support members and those seeking service.
 5. Monitoring and mitigating peer support member emotional fatigue (i.e., compassion fatigue) associated with providing peer support.
 6. Using qualified peer support personnel from other public safety agencies or outside organizations for department peer support, as appropriate.
- (c) Verifying members have reasonable access to peer support or licensed psychotherapist support.
- (d) Establishing procedures for CISDs, including:
1. Defining the types of incidents that may initiate debriefings.
 2. Steps for organizing debriefings.
- (e) Facilitating the delivery of wellness information, training, and support through various methods appropriate for the situation (e.g., phone hotlines, electronic applications).
- (f) Verifying a confidential, appropriate, and timely Employee Assistance Program (EAP) is available for members. This also includes:
1. Obtaining a written description of the program services.
 2. Providing for the methods to obtain program services.
 3. Providing referrals to the EAP for appropriate diagnosis, treatment, and follow-up resources.
 4. Obtaining written procedures and guidelines for referrals to, or mandatory participation in, the program.
 5. Obtaining training for supervisors in their role and responsibilities, and identification of member behaviors that would indicate the existence of member concerns, problems, or issues that could impact member job performance.
- (g) Assisting members who have become disabled with application for federal government benefits such as those offered through the Public Safety Officers' Benefits Program (34 USC § 10281 et seq.).
1. The coordinator should work with appropriate department liaisons to assist qualified members and survivors with benefits, wellness support, and counseling

Culver City Police Department

Culver City PD Policy Manual

Wellness Program

services, as applicable, when there has been a member death (see the Line-of-Duty Deaths Policy for additional guidance).

1030.4 DEPARTMENT PEER SUPPORT

1030.4.1 PEER SUPPORT MEMBER SELECTION CRITERIA

The selection of a department peer support member will be at the discretion of the coordinator. Selection should be based on the member's:

- Desire to be a peer support member.
- Experience or tenure.
- Demonstrated ability as a positive role model.
- Ability to communicate and interact effectively.
- Evaluation by supervisors and any current peer support members.

1030.4.2 PEER SUPPORT MEMBER RESPONSIBILITIES

The responsibilities of department peer support members include:

- (a) Providing pre- and post-critical incident support.
- (b) Presenting department members with periodic training on wellness topics, including but not limited to:
 1. Stress management.
 2. Suicide prevention.
 3. How to access support resources.
- (c) Providing referrals to licensed psychotherapists and other resources, where appropriate.
 1. Referrals should be made to department-designated resources in situations that are beyond the scope of the peer support member's training.

1030.4.3 PEER SUPPORT MEMBER TRAINING

A department peer support member should complete department-approved training prior to being assigned.

1030.5 CRITICAL INCIDENT STRESS DEBRIEFINGS

A Critical Incident Stress Debriefing should occur as soon as practicable following a critical incident. The coordinator is responsible for organizing the debriefing. Notes and recorded statements shall not be taken because the sole purpose of the debriefing is to help mitigate the stress-related effects of a critical incident.

The debriefing is not part of any investigative process. Care should be taken not to release or repeat any communication made during a debriefing unless otherwise authorized by policy, law, or a valid court order.

Culver City Police Department

Culver City PD Policy Manual

Wellness Program

Attendance at the debriefing should only include peer support members and those directly involved in the incident.

1030.6 PEER SUPPORT COMMUNICATIONS

Although the Department will honor the sensitivity of communications with peer support members, there is no legal privilege to such communications, unless authorized by law (e.g., peer support communications pursuant to a Law Enforcement Peer Support and Crisis Referral Service Program).

1030.7 PHYSICAL WELLNESS PROGRAM

1030.8 WELLNESS PROGRAM AUDIT

At least annually, the coordinator or the authorized designee should audit the effectiveness of the department's wellness program and prepare a report summarizing the findings. The report shall not contain the names of members participating in the wellness program, and should include the following information:

- Data on the types of support services provided
- Wait times for support services
- Participant feedback, if available
- Program improvement recommendations
- Policy revision recommendations

The coordinator should present the completed audit to the Chief of Police for review and consideration of updates to improve program effectiveness.

1030.9 TRAINING

The coordinator or the authorized designee should collaborate with the Personnel and Training Lieutenant to provide all members with regular training on topics related to member wellness, including but not limited to:

- The availability and range of department wellness support systems.
- Suicide prevention.
- Recognizing and managing mental distress, emotional fatigue, post-traumatic stress, and other possible reactions to trauma.
- Alcohol and substance disorder awareness.
- Countering sleep deprivation and physical fatigue.
- Anger management.
- Marriage and family wellness.
- Benefits of exercise and proper nutrition.
- Effective time and personal financial management skills.

Culver City Police Department

Culver City PD Policy Manual

Wellness Program

Training materials, curriculum, and attendance records should be forwarded to the Personnel and Training Lieutenant as appropriate for inclusion in training records.

Wellness Dog Program

1031.1 PURPOSE AND SCOPE

The purpose of this policy is to provide guidelines for the use and management of therapy dog(s) for a Wellness Dog Program, which should not be confused with a service dog. This policy is intended to be a guide for those persons or staff interacting with the Wellness Dog assigned to the Department including supporting the interaction between the Wellness Dog and community members. The safety Department employees and the community, as well as the proper care of the Wellness Dog must be insured.

The Wellness Dog Program will be under the administrative and operational control of the Culver City Police Department. Direct supervision and care for the Wellness Dog will be the responsibility of the employee to which the Wellness Dog is assigned.

1031.2 DEFINITIONS

Wellness Dog- A dog trained to affection, comfort, and love to people.

Service Dog- A dog trained to provide a specific service for a person with special needs.

1031.3 PROGRAM OVERVIEW

The Wellness Dog Program was developed to provide emotional and psychological support for the members of the Culver City Police Department. This dog can be used to reduce stress and improve morale in the workplace. The Wellness Dog may also be deployed in the field at community engagement events and for emotional support at Critical Incidents.

1031.4 NECESSARY EQUIPMENT AND CARE PROVIDED BY DEPARTMENT

- XL Dog Crate with Primo Pad and lock down system
- Wellness Dog Harness with Department Patches
- 6 Ft Leash
- Retractable Leash
- Dog Bed
- Two steel dishes
- All food
- Toys
- All grooming and Veterinary care

1031.5 FUNCTION AND UTILIZATION

The primary function of a Wellness Dog is to be part of the workforce as much as possible. The Wellness Dog shall be available for employees to interact with. Under the direct supervision of

Culver City Police Department

Culver City PD Policy Manual

Wellness Dog Program

a properly trained Wellness Dog Handler, the Wellness Dog can also be used as a community engagement tool at community events.

1031.6 WELLNESS DOG HANDLER RESPONSIBILITIES

A Department member appointed by the Chief of Police or the authorized designee will serve as the Wellness Dog Handler. The responsibilities of the Wellness Dog Handler will include overseeing the following:

- To ensure that the Wellness Dog has veterinary care as needed.
- The Wellness Dog is fed as needed. Other than the appropriate amount of treats throughout the day, the Wellness Dog shall not be fed any other food.
- While the Wellness Dog is in its bed, the area surrounding the bed shall be free from any hazardous conditions and within sight of the Wellness Dog Handler.
- The Wellness Dog shall have a designated area away from the public eye to relieve itself. Each personnel walking the Wellness Dog has the responsibility to clean up after the dog has relieved itself, and to dispose of the waste appropriately.
- Proper hygienic measures shall be implemented to ensure the cleanliness of the Wellness Dog in order to minimize any dander or residual hair that may be left by the dog. This shall include:
 - Establishing a "No Dog Zone" within the Culver City Police Department. Staff will be made aware of this area. This is usually a break room or where staff eats.
 - Tending to the Wellness Dog's grooming needs.
 - Daily and thorough brushing of the dog's coat to minimize hair left behind by the dog.
 - Special pet wipes will be used to refresh the dog's coat in between bathing.
 - Regular vacuuming of the Wellness Dog Handler's office, and any other area frequented by the dog.
 - Pads and/or bedding utilized by the dog shall be laundered in hot water on a regular basis.

The Wellness Dog Handler will have been trained to recognize the signs of distress that the staff and/or public may exhibit when there is a concern regarding the dog's presence. The Wellness Dog Handler will take appropriate actions to minimize contact with those who express their fear and/or show distress in the dog's presence.

1031.7 ACCOMMODATIONS FOR PERSONS WITH FEAR OR ALLERGIES OF DOGS

Signs will be posted at the entrance of the Culver City Police Department to inform visitors of the presence of the Wellness Dog.

In the event that a visitor enters the Department and expresses that they have an allergy or fear of the dog, the dog shall be crated during the duration of that person's time in the Department in order to minimize contact with the dog. In the event that a Culver City Police Department employee

Culver City Police Department

Culver City PD Policy Manual

Wellness Dog Program

expresses a fear or allergy to the Wellness Dog, all reasonable efforts will be made to keep the Wellness Dog out of the employee's presence.

1031.8 PLAYTIME, BREAKS, FOOD AND SOCIALIZATION

The Wellness Dog should not play in work areas. The Wellness Dog is to be used as an emotional support system for Department personnel and the public. The Wellness Dog is trained to play when not in work mode.

The Wellness Dog should be kept on his/her bed at the workplace. The Wellness Dog may get up off his/her bed when asked. He/She may also get up to be pet, bathroom breaks, or walks.

The Wellness Dog must be on leash when walked outside.

No food should be offered to the Wellness Dog without the Wellness Dog Supervisor's permission and the Wellness Dog should never be fed "human food."

The Wellness Dog's assignment is for personnel and victims and should not socialize with the public without authorization.

1031.9 DOCUMENTATION OF INCIDENTS

Should the Wellness Dog be involved in any incident that causes trauma or significant fear for a Culver City police Department Employee or member of the public, the Personnel and Training Lieutenant or the Watch Commander shall be notified immediately and the incident shall be documented in an officer's report.

Should the Wellness Dog injure a Culver City Police Department employee or member of the public, the Personnel and Training Lieutenant or the Watch Commander shall be notified immediately and the incident shall be documented in an officer's report. Additionally, should the Wellness Dog be injured in any way, the Personnel and Training Lieutenant or the Watch Commander shall be notified immediately and the incident shall be documented in an officer's report.

1031.10 WELLNESS DOG HANDLER TRAINING

Prior to assuming the duties of a Wellness Dog Handler, employees shall complete an initial handler training program. Wellness Dog handlers shall also complete an annual training update course.

Attachments

Hate Crime Checklist.pdf

HATE CRIME CHECKLIST

Page _____ of _____

VICTIM	<p style="text-align: center;"><u>Victim Type:</u></p> <p><input type="checkbox"/> Individual Legal name (Last, First): _____ Other Names used (AKA): _____</p> <p><input type="checkbox"/> School, business or organization Name: _____ Type: _____ <i>(e.g., non-profit, private, public school)</i> Address: _____</p> <p><input type="checkbox"/> Faith-based organization Name: _____ Faith: _____ Address: _____</p>	<p style="text-align: center;"><u>Target of Crime (Check all that apply):</u></p> <p><input type="checkbox"/> Person <input type="checkbox"/> Private property <input type="checkbox"/> Public property</p> <p><input type="checkbox"/> Other _____</p> <p style="text-align: center;"><u>Nature of Crime (Check all that apply):</u></p> <p><input type="checkbox"/> Bodily injury <input type="checkbox"/> Threat of violence</p> <p><input type="checkbox"/> Property damage</p> <p><input type="checkbox"/> Other crime: _____</p> <p>Property damage - estimated value _____</p>
---------------	---	--

BIAS	<p style="text-align: center;"><u>Type of Bias</u> (Check all characteristics that apply):</p> <p><input type="checkbox"/> Disability</p> <p><input type="checkbox"/> Gender</p> <p><input type="checkbox"/> Gender identity/expression</p> <p><input type="checkbox"/> Sexual orientation</p> <p><input type="checkbox"/> Race</p> <p><input type="checkbox"/> Ethnicity</p> <p><input type="checkbox"/> Nationality</p> <p><input type="checkbox"/> Religion</p> <p><input type="checkbox"/> Significant day of offense <i>(e.g., 9/11, holy days)</i></p> <p><input type="checkbox"/> Other: _____</p> <p>Specify disability (be specific): _____ _____</p>	<p style="text-align: center;"><u>Actual or Perceived Bias – Victim’s Statement:</u></p> <p><input type="checkbox"/> Actual bias [Victim actually has the indicated characteristic(s)].</p> <p><input type="checkbox"/> Perceived bias [Suspect believed victim had the indicated characteristic(s)]. <i>If perceived, explain the circumstances in narrative portion of Report.</i></p> <p style="text-align: center;"><u>Reason for Bias:</u></p> <p>Do you feel you were targeted based on one of these characteristics? <input type="checkbox"/> Yes <input type="checkbox"/> No <i>Explain in narrative portion of Report.</i></p> <p>Do you know what motivated the suspect to commit this crime? <input type="checkbox"/> Yes <input type="checkbox"/> No <i>Explain in narrative portion of Report.</i></p> <p>Do you feel you were targeted because you associated yourself with an individual or a group? <input type="checkbox"/> Yes <input type="checkbox"/> No <i>Explain in narrative portion of Report.</i></p> <p>Are there indicators the suspect is affiliated with a Hate Group (i.e., literature/tattoos)? <input type="checkbox"/> Yes <input type="checkbox"/> No <i>Describe in narrative portion of Report.</i></p> <p>Are there Indicators the suspect is affiliated with a criminal street gang? <input type="checkbox"/> Yes <input type="checkbox"/> No <i>Describe in narrative portion of Report.</i></p>
-------------	--	---

	<p style="text-align: center;"><u>Bias Indicators (Check all that apply):</u></p> <p><input type="checkbox"/> Hate speech <input type="checkbox"/> Acts/gestures <input type="checkbox"/> Property damage <input type="checkbox"/> Symbol used</p> <p><input type="checkbox"/> Written/electronic communication <input type="checkbox"/> Graffiti/spray paint <input type="checkbox"/> Other: _____</p> <p><i>Describe with exact detail in narrative portion of Report.</i></p>
--	--

HISTORY	<p style="text-align: center;"><u>Relationship Between Suspect & Victim:</u></p> <p>Suspect known to victim? <input type="checkbox"/> Yes <input type="checkbox"/> No</p> <p>Nature of relationship: _____</p> <p>Length of relationship: _____</p> <p><i>If Yes, describe in narrative portion of Report</i></p>	<p><input type="checkbox"/> Prior reported incidents with suspect? Total # _____</p> <p><input type="checkbox"/> Prior unreported incidents with suspect? Total # _____</p> <p>Restraining orders? <input type="checkbox"/> Yes <input type="checkbox"/> No</p> <p><i>If Yes, describe in narrative portion of Report</i></p> <p>Type of order: _____ Order/Case# _____</p>
----------------	--	--

WEAPONS	<p>Weapon(s) used during incident? <input type="checkbox"/> Yes <input type="checkbox"/> No Type: _____</p> <p>Weapon(s) booked as evidence? <input type="checkbox"/> Yes <input type="checkbox"/> No</p> <p>Automated Firearms System (AFS) Inquiry attached to Report? <input type="checkbox"/> Yes <input type="checkbox"/> No</p>
----------------	--

HATE CRIME CHECKLIST

Page ____ of ____

EVIDENCE	Witnesses present during incident? <input type="checkbox"/> Yes <input type="checkbox"/> No	Statements taken? <input type="checkbox"/> Yes <input type="checkbox"/> No
	Evidence collected? <input type="checkbox"/> Yes <input type="checkbox"/> No	Recordings: <input type="checkbox"/> Video <input type="checkbox"/> Audio <input type="checkbox"/> Booked
	Photos taken? <input type="checkbox"/> Yes <input type="checkbox"/> No	Suspect identified: <input type="checkbox"/> Field ID <input type="checkbox"/> By photo
	Total # of photos: _____ D#: _____ Taken by: _____ Serial #: _____	<input type="checkbox"/> Known to victim

OBSERVATIONS	<u>VICTIM</u>	<u>SUSPECT</u>
	<input type="checkbox"/> Tattoos <input type="checkbox"/> Shaking <input type="checkbox"/> Unresponsive <input type="checkbox"/> Crying <input type="checkbox"/> Scared <input type="checkbox"/> Angry <input type="checkbox"/> Fearful <input type="checkbox"/> Calm <input type="checkbox"/> Agitated <input type="checkbox"/> Nervous <input type="checkbox"/> Threatening <input type="checkbox"/> Apologetic <input type="checkbox"/> Other observations: _____	<input type="checkbox"/> Tattoos <input type="checkbox"/> Shaking <input type="checkbox"/> Unresponsive <input type="checkbox"/> Crying <input type="checkbox"/> Scared <input type="checkbox"/> Angry <input type="checkbox"/> Fearful <input type="checkbox"/> Calm <input type="checkbox"/> Agitated <input type="checkbox"/> Nervous <input type="checkbox"/> Threatening <input type="checkbox"/> Apologetic <input type="checkbox"/> Other observations: _____

ADDITIONAL QUESTIONS (Explain all boxes marked "Yes" in narrative portion of report):

Has suspect ever threatened you?	<input type="checkbox"/> Yes	<input type="checkbox"/> No
Has suspect ever harmed you?	<input type="checkbox"/> Yes	<input type="checkbox"/> No
Does suspect possess or have access to a firearm?	<input type="checkbox"/> Yes	<input type="checkbox"/> No
Are you afraid for your safety?	<input type="checkbox"/> Yes	<input type="checkbox"/> No
Do you have any other information that may be helpful?	<input type="checkbox"/> Yes	<input type="checkbox"/> No

Resources offered at scene: Yes No Type: _____

MEDICAL	<u>Victim</u>	<u>Suspect</u>	Paramedics at scene? <input type="checkbox"/> Yes <input type="checkbox"/> No Unit # _____
	<input type="checkbox"/>	<input type="checkbox"/>	Declined medical treatment
	<input type="checkbox"/>	<input type="checkbox"/>	Will seek own medical treatment
	<input type="checkbox"/>	<input type="checkbox"/>	Received medical treatment
Authorization to Release Medical Information, Form 05.03.00, signed? <input type="checkbox"/> Yes <input type="checkbox"/> No			Name(s)/ID #: _____
			Hospital: _____
			Jail Dispensary: _____
			Physician/Doctor: _____
			Patient #: _____

Officer (Name/Rank)	Date
Officer (Name/Rank)	Date
Supervisor Approving (Name/Rank)	Date

Supplemental Hate Crime Report-Agency.pdf

SUPPLEMENTAL HATE CRIME REPORT

Hate incident (No Crime Committed)

Hate Crime (422.6 PC, 51.7 CC, 52.1 CC)

VICTIM				
VICTIM TYPE			Date and time of incident: _____	
<input type="checkbox"/> Individual Legal name (Last, First): _____			Location of incident: _____	
Date of Birth	Age	Sex	Date and time of report: _____	
			Location of report: _____	
<input type="checkbox"/> School, business or organization Name: _____ Type: _____ <i>(e.g., non-profit, private, public school)</i>			Agency Case #: _____	
<input type="checkbox"/> Faith-based organization Name: _____ Faith: _____			NATURE OF CALL FOR SERVICE (check all that apply) <input type="checkbox"/> Crime against persons <input type="checkbox"/> Crime against property <input type="checkbox"/> Gang activity <input type="checkbox"/> Other _____	
<input type="checkbox"/> Other Name: _____ Type: _____ Address: _____				

BIAS	
<p style="text-align: center;">TYPE OF BIAS <i>(Check all characteristics that apply)</i></p> <input type="checkbox"/> Disability <input type="checkbox"/> Gender <input type="checkbox"/> Gender identity/expression <input type="checkbox"/> Sexual orientation <input type="checkbox"/> Race <input type="checkbox"/> Ethnicity <input type="checkbox"/> Nationality <input type="checkbox"/> Religion <input type="checkbox"/> Significant day of offense <i>(e.g., 9/11, holy days)</i> <input type="checkbox"/> Association with a person or group with one or more of these characteristics (actual or perceived) <input type="checkbox"/> Other: _____	<p style="text-align: center;">ACTUAL OR PERCEIVED BIAS – VICTIM’S STATEMENT</p> <input type="checkbox"/> Actual bias [Victim has the indicated characteristic(s)]. <input type="checkbox"/> Perceived bias [Suspect believed victim had the indicated characteristic(s)].
	<p style="text-align: center;">REASON FOR BIAS:</p> Do you feel you were targeted based on one of these characteristics? <input type="checkbox"/> Yes <input type="checkbox"/> No Do you know what motivated the suspect to commit this crime? <input type="checkbox"/> Yes <input type="checkbox"/> No Do you feel you were targeted because you associated yourself with an individual or a group? <input type="checkbox"/> Yes <input type="checkbox"/> No Are there indicators the suspect is affiliated with a Hate Group (i.e., literature/tattoos)? <input type="checkbox"/> Yes <input type="checkbox"/> No Are there Indicators the suspect is affiliated with a criminal street gang? <input type="checkbox"/> Yes <input type="checkbox"/> No
<p style="text-align: center;">BIAS INDICATORS (CHECK ALL THAT APPLY):</p> <input type="checkbox"/> Hate speech <input type="checkbox"/> Acts/gestures <input type="checkbox"/> Property damage <input type="checkbox"/> Symbol used <input type="checkbox"/> Written/electronic communication <input type="checkbox"/> Graffiti/spray paint <input type="checkbox"/> Other: _____	

SUPPLEMENTAL HATE CRIME REPORT

Page 2 of 2

HISTORY

SUSPECT INFORMATION				RELATIONSHIP BETWEEN SUSPECT & VICTIM	
Legal name (Last, First): _____				Suspect known to victim: <input type="checkbox"/> Yes <input type="checkbox"/> No	
Other Names used (AKA): _____				Nature of relationship: _____	
Date of Birth	Age	Sex	Race	Length of relationship: _____	
				<input type="checkbox"/> Prior reported incidents with suspect: <i>Total #</i> _____	
Relationship to Victim: _____				Prior unreported incidents with suspect: <input type="checkbox"/> Yes <input type="checkbox"/> No <input type="checkbox"/> Unknown	

WEAPONS/FORCE

Weapon(s) used during incident?	<input type="checkbox"/> Yes	<input type="checkbox"/> No	Type: _____
Force used during incident?	<input type="checkbox"/> Yes	<input type="checkbox"/> No	Type: _____

EVIDENCE

Witnesses present during incident?	<input type="checkbox"/> Yes	<input type="checkbox"/> No	Statements taken?	<input type="checkbox"/> Yes	<input type="checkbox"/> No	
Evidence collected?	<input type="checkbox"/> Yes	<input type="checkbox"/> No	Recordings:	<input type="checkbox"/> Video	<input type="checkbox"/> Audio	<input type="checkbox"/> Booked
Photos taken?	<input type="checkbox"/> Yes	<input type="checkbox"/> No	Suspect identified:	<input type="checkbox"/> Field ID	<input type="checkbox"/> By photo/video	<input type="checkbox"/> Known

RESOURCES

Resources offered at scene:	<input type="checkbox"/> Yes	<input type="checkbox"/> No
<input type="checkbox"/> Marsy's Law Handout	<input type="checkbox"/> Hate Crimes Brochure	<input type="checkbox"/> Other: _____

MEDICAL

Victim	Suspect	
<input type="checkbox"/>	<input type="checkbox"/>	Declined medical treatment
<input type="checkbox"/>	<input type="checkbox"/>	Will seek own medical treatment
<input type="checkbox"/>	<input type="checkbox"/>	Received medical treatment
<input type="checkbox"/>	<input type="checkbox"/>	Injuries observed

Completed by	Date
_____	_____
Name/Title/ID number	

Supplemental Hate Crime Report.pdf

Hate incident (No Crime Committed)

Hate Crime (422.6 PC, 51.7 CC, 52.1 CC)

VICTIM

VICTIM TYPE

Individual

Legal name (Last, First):

Date of Birth	Age	Sex	Race

School, business or organization

Name: _____

Type: _____
 (e.g., non-profit, private, public school)

Faith-based organization

Name: _____

Faith: _____

Other

Name: _____

Type: _____

Address: _____

Date and time of incident:

Location of incident:

Date and time of report:

Location of report:

Agency Case #:

NATURE OF CALL FOR SERVICE (check all that apply)

Crime against persons

Crime against property

Gang activity

Other _____

BIAS

TYPE OF BIAS

(Check all characteristics that apply)

Disability

Gender

Gender identity/expression

Sexual orientation

Race

Ethnicity

Nationality

Religion

Significant day of offense

(e.g., 9/11, holy days)

Association with a person or group with one or more of these characteristics (actual or perceived)

Other: _____

ACTUAL OR PERCEIVED BIAS – VICTIM’S STATEMENT

Actual bias [Victim has the indicated characteristic(s)].

Perceived bias [Suspect believed victim had the indicated characteristic(s)].

REASON FOR BIAS:

Do you feel you were targeted based on one of these characteristics?

Yes No

Do you know what motivated the suspect to commit this crime?

Yes No

Do you feel you were targeted because you associated yourself with an individual or a group?

Yes No

Are there indicators the suspect is affiliated with a Hate Group (i.e., literature/tattoos)?

Yes No

Are there Indicators the suspect is affiliated with a criminal street gang?

Yes No

BIAS INDICATORS (CHECK ALL THAT APPLY):

Hate speech

Acts/gestures

Property damage

Symbol used

Written/electronic communication

Graffiti/spray paint

Other: _____

HISTORY

SUSPECT INFORMATION				RELATIONSHIP BETWEEN SUSPECT & VICTIM			
Legal name (Last, First): _____				Suspect known to victim: <input type="checkbox"/> Yes <input type="checkbox"/> No			
Other Names used (AKA): _____				Nature of relationship: _____			
Date of Birth	Age	Sex	Race	Length of relationship: _____			
				<input type="checkbox"/> Prior reported incidents with suspect: <i>Total #</i> _____			
Relationship to Victim: _____				Prior unreported incidents with suspect: <input type="checkbox"/> Yes <input type="checkbox"/> No <input type="checkbox"/> Unknown			

WEAPONS/FORCE

Weapon(s) used during incident? Yes No Type: _____

Force used during incident? Yes No Type: _____

EVIDENCE

Witnesses present during incident? Yes No Statements taken? Yes No

Evidence collected? <input type="checkbox"/> Yes <input type="checkbox"/> No	Recordings:	<input type="checkbox"/> Video	<input type="checkbox"/> Audio	<input type="checkbox"/> Booked
Photos taken? <input type="checkbox"/> Yes <input type="checkbox"/> No	Suspect identified:	<input type="checkbox"/> Field ID	<input type="checkbox"/> By photo/video	<input type="checkbox"/> Known

RESOURCES

Resources offered at scene: Yes No

Marsy's Law Handout Hate Crimes Brochure Other: _____

MEDICAL

Victim	Suspect	
<input type="checkbox"/>	<input type="checkbox"/>	Declined medical treatment
<input type="checkbox"/>	<input type="checkbox"/>	Will seek own medical treatment
<input type="checkbox"/>	<input type="checkbox"/>	Received medical treatment
<input type="checkbox"/>	<input type="checkbox"/>	Injuries observed

Completed by	Date
Name/Title/ID number	

Military Equipment Attachments.pdf

ATTACHMENTS

MILITARY EQUIPMENT INVENTORY PDF

1. Robot (Category 1): Not yet obtained. To be purchased after the acquisition of approved grant funds.
 - a. **Description, quantity, capabilities, and purchase cost:**

The Transcend Tactical Vantage F3 Robot is a remotely controlled unmanned machine that operates on the ground, which is utilized to enhance the safety of the community and officers. This device can be remotely operated from many hundred meters away, providing protection and safety to their operators. The utilization of this Robot allows for de-escalation and the peaceful surrender and arrest of a violent suspect while reducing the potential of an armed confrontation with officers that may lead to a lethal conclusion.
 - b. **Purpose:**

To be used as a de-escalation tool and to remotely gain visual/audio data, deliver CNT phone, open doors, disrupt packages, clear buildings, and administer tear gas during a barricaded suspect incident (with explicit direction from Bureau Commander or Police Chief). While remote observation is the primary function of the Robot, these auxiliary roles of transporting communication devices or other resources (such as food or water) into an inherently unstable situation, will help promote a peaceful conclusion.
 - c. **Authorized Use:**
 - I. Can be operated after supervisor approval and only by trained officers during critical incidents or pre-planned tactical operations.
 - II. During Department-approved training exercises.
 - III. The Gas Deployment Accessory can only be used after approval from a Bureau Commander or Chief of Police.
 - IV. In compliance with Department policy and procedures, as well as federal, state, and local laws and ordinances.
 - d. **Expected Lifespan:**

N/A
 - e. **Fiscal Impact:**

Robot: \$25,000.00
Gas Deployment Accessory: \$6,000.00
NOTE: Robot and Accessory will be fully funded by Urban Areas Security Initiative (UASI) program grant.
2. Unmanned Aerial Vehicles (Category 1)
 - a. **Description, quantity, capabilities, and purchase cost:**
 1. DJI Matrice 210 unmanned aerial vehicle (UAV) Cost: \$7422.80 each. Quantity:
 2. The DJI Matrice 210 is a commercial-grade UAV. This UAV is a battery-powered, remote-operated device. Controller: GL800A Cendence controller with tablet holder attachment. The controller allows operators to control UAV and view

a live feed from UAV-mounted cameras through an attached and connected tablet. Cameras (2): Zenmuse Z30 RGB camera and Zenmuse XT camera with FLIR capabilities. The cameras allow operators to switch between standard RGB cameras and views based on the heat of objects within the frame. Flight time of approximately 15-25 minutes per battery, depending on weather and flight conditions. Capabilities: Commonly used by construction and utility companies for the inspection of buildings, powerlines, windmills, and other infrastructure. This UAV has also proven to be useful to public safety agencies in firefighting, search and rescue, pre-operational intelligence, and other tactical situations where aerial views enhance the safety and efficiency of law enforcement and fire personnel. The manufacturer's description is attached.

2. DJI Mavic 2 Enterprise Advanced unmanned aerial vehicle (UAV), cost: \$6240.00 each. Quantity: 4. The DJI Mavic 2 Enterprise Advanced is a commercial-grade UAV. This UAV is a battery-powered, remote-operated device. Controller: DJI Smart Controller All-in-one controller with 5.5- inch integrated screen. The controller allows operators to control UAV and view a live feed from UAV-mounted cameras. Cameras: Integrated M2EA camera with dual RGB and FLIR capabilities. The camera provides operators with the ability to switch between standard RGB camera and views based on the heat of objects within frame. Flight time of approximately 25-30 minutes per battery, depending on weather and flight conditions. Commonly used by construction and utility companies for the inspection of buildings, powerlines, windmills, and other infrastructure. This UAV has also proven to be useful to public safety agencies in firefighting, search and rescue, pre-operational intelligence, and other tactical situations where aerial views enhance the safety and efficiency of law enforcement and fire personnel. The manufacturer's description is attached.
3. DJI Phantom Pro 4 unmanned aerial vehicle (UAV), cost: \$1566.40 each. Quantity: 2. The DJI Phantom Pro 4 is a commercial-grade UAV. This UAV is a battery-powered, remote-operated device. Controller: DJI GL300F controller with tablet holder attachment. The controller allows operators to control UAV and view a live feed from UAV-mounted cameras through an attached and connected tablet. Cameras: Integrated camera with RGB capabilities. Flight time of approximately 25-30 minutes per battery, depending on weather and flight conditions. Commonly used by construction and utility companies for the inspection of buildings, powerlines, windmills, and other infrastructure. This UAV has also proven to be useful to public safety agencies in firefighting, search and rescue, pre-operational intelligence, and other tactical situations where aerial views enhance the safety and efficiency of law enforcement and fire personnel. The manufacturer's description is attached.
4. Sky-Hero Loki Mk2 unmanned aerial vehicle (UAV) Cost: \$9750.00. Quantity: 2 (sold as a set //two aircraft, one controller). The Sky-Hero Loki Mk2 is a commercial-grade UAV. This UAV is a battery-powered, remote-operated device. Controller: Sky-Hero controller with 5- inch integrated screen. The controller allows operators to control UAV and view a live feed from UAV-mounted cameras. Cameras: Integrated camera with dual RGB and IR capabilities. The cameras provide operators with the ability to see in low-light indoor environments. Flight time of approximately 15 minutes per battery. This UAV is a specialized indoor tactical reconnaissance vehicle. Intended use is for public safety agencies in indoor tactical operations, where the view from an unmanned vehicle will significantly enhance the safety of law enforcement personnel and others within

the operational area. The manufacturer's description is attached.

b. **Purpose:**

To be deployed when its view would assist officers or incident commanders with the following situations, which include:

- I. Barricaded Suspects
- II. Active Shooter/ Mass Casualty Incidents
- III. Hostage Situations
- IV. Crime Scene Investigations
- V. Search & Rescue Operations
- VI. Fires
- VII. Disaster Management
- VIII. CBRNE Incident (chemical, biological, radiological, nuclear, and/or explosive)
- IX. Supporting Search and Arrest Warrant Operations
- X. Perimeter Searches for Armed and/or Felony Suspects
- XI. Routine Training (public places)

c. **Authorized Use:**

- I. Only assigned operators who have completed the required FAA training and have a current FAA Part 107 Remote Pilot Certificate shall be permitted to operate the above-listed UAVs during approved missions.
- II. Requests to deploy the UAV shall be approved by the on-duty Watch Commander, supervisor on scene, or the UAV Manager prior to accepting the mission.
- III. In compliance with Department Policy 349 (Unmanned Aerial Vehicle Operations), as well as federal, state, and local laws and ordinances.

d. **Expected Lifespan:**

10 years

e. **Fiscal Impact:**

No known annual maintenance cost.

3. Armored Personnel Carrier (Category 2 & 3)

a. **Description, quantity, capabilities, and purchase cost:**

NONE

b. **Purpose:**

N/A

c. **Authorized Use:**

N/A

d. **Expected Lifespan:**

N/A

e. **Fiscal Impact:**

N/A

4. Tracked Armored Vehicles (Category 4)

a. **Description, quantity, capabilities, and purchase cost:**

NONE

b. **Purpose:**
N/A

c. **Authorized Use:**
N/A

d. **Expected Lifespan:**
N/A

e. **Fiscal Impact:**
N/A

5. Command and Control Vehicles (Category 5)

a. **Description, quantity, capabilities, and purchase cost:**

Command Post Mobile Trailer: 2020 Forest River 30ft trailer w/ 2 Axles. There is no cost for the trailer as the State of California donated it. The trailer will be equipped with 3 monitors (2 interior/1 exterior), desks, chairs, IP phones, exterior spotlight, soundproof room, and initial wiring for a computer setup.

b. **Purpose:**

To be utilized during critical incidents, major disasters, pre-planned high-risk warrant operations, large-scale pre-planned events, natural disasters, and public relations/community outreach events.

c. **Authorized Use:**

- I. The Command Post Mobile trailer will be deployed by officers and staff who have received department training in pulling/deploying trailers.
- II. The driver of the vehicle shall have a valid California driver's license (class C)
- III. In compliance with Department Policy 703 (Vehicle Use), as well as federal, state, and local laws and ordinances.

d. **Expected Lifespan:**
30-year life span

e. **Fiscal Impact:**
Retrofitting cost \$15,894.15.

6. Weaponized aircraft or vessel (Category 6)

a. **Description, quantity, capabilities, and purchase cost:**
NONE

b. **Purpose:**
N/A

c. **Authorized Use:**
N/A

d. **Expected Lifespan:**
N/A

- e. **Fiscal Impact:**
N/A
7. Breaching Apparatus: Slugs, Energetic Breaching Program (Category 7)
- a. **Description, quantity, capabilities, and purchase cost:**
NONE
 - b. **Purpose:**
N/A
 - c. **Authorized Use:**
N/A
 - d. **Expected Lifespan:**
N/A
 - e. **Fiscal Impact**
N/A
8. Firearms and ammunition of .50 caliber or greater, excluding standard-issue shotguns and standard-issue shotgun ammunition (Equipment Category 8)
- a. **Description, quantity, capabilities, and purchase cost:**
NONE
 - b. **Purpose:**
N/A
 - c. **Authorized Use:**
N/A
 - d. **Expected Lifespan:**
N/A
 - e. **Fiscal Impact:**
N/A
9. Specialized Firearms and Ammunition (Category 9)
- a. **Description, quantity, capabilities, and purchase cost:**
 - I. The Carbine Rifle is a firearm capable of accurately stopping an armed subject at various distances. The Carbine Rifle is a lightweight, air-cooled, magazine-fed, shoulder-fired weapon designed for semi-automatic fire. The .223 / 5.56 cartridge is used as a lethal option designed to stop a violent encounter. The projectile is capable of penetrating soft body armor being worn by armed subjects. Total Quantity: 123 (LWRCI M61C-DI, quantity: 99; LWRCI M61C-G, quantity: 15; Colt Commando, quantity: 1; Colt M4 Carbine, quantity: 4; Colt Sporter Lightweight, quantity: 1; Bushmaster XM15-E2S, quantity: 2; Double Star 15, quantity: 1). The manufacturer's description is attached.
 - II. The Hornady 556 NATO, 75 grain, BTHP Tap Precision cartridge is the primary duty ammunition deployed during potential lethal encounters. Quantity: 2,200 rounds. The manufacturer's description is attached.

- III. The Hornady 556 NATO, 75 grain, Tap SBR cartridge is the primary training ammunition for the department. Quantity: 4,500 rounds. The manufacturer's description is attached.
- IV. The Winchester .223 Remington, 55 grain, Ranger RA223SF cartridge is the secondary training ammunition for the department, designated for indoor shooting. Quantity: 7,600 rounds. The manufacturer's description is attached.
- V. The Sniper Rifle is a firearm used by ERT operators who are supplementally trained to engage armed suspects from a safe distance. Daniel Defense DD5V4; Caliber: 7.62 x 51mm; quantity: 2. The manufacturer's description is attached.

b. **Purpose:**

To be used as precision weapons to address a deadly threat with more precision and/or greater distances than a handgun, if present and feasible. Guns that are fired from shoulder level have a longer, grooved barrel intended to make bullets spin and thereby have greater accuracy over a long distance. Potential applications include hostage situations and an active shooter.

c. **Authorized Use:**

- I. Only members that have completed a POST-certified rifle course and, on an annual basis
- II. Having completed the department-approved range qualification, with the department's range staff are authorized to deploy a rifle.
- III. In compliance with Department Policies 307 (Firearms), 416 (Rifles), and 300 (Use of Force), as well as federal, state, and local laws and ordinances.

d. **Expected Lifespan:**

- I. Carbine Rifle- No expiration (serviced or replaced when it fails or breaks)
- II. The Hornady 556 NATO, 75 grain, BTHP Tap Precision cartridge-15 years
- III. The Hornady 556 NATO, 75 grain, Tap SBR cartridge- 15 years
- IV. The Winchester .223 Remington, 55 grain, Ranger RA223SF cartridge-15 years
- V. Sniper Rifle- No expiration (service or replaced when it fails or breaks)

e. **Fiscal Impact:**

- I. Carbine Rifle – No annual cost unless replacement purchases are necessary (Purchase price: \$1,554.96 each)
- II. The Hornady 556 NATO, 75 grain, BTHP Tap Precision cartridge - Annual cost approximately \$6,250.00
- III. The Hornady 556 NATO, 75 grain, Tap SBR cartridge - Annual cost approximately \$2,954.00
- IV. The Winchester .223 Remington, 55 grain, Ranger RA223SF cartridge - Annual cost approximately \$6,810.00
- V. Sniper Rifle - No annual cost unless replacement purchases are necessary (Purchase price: \$1,949.22 each)

9. Any firearm or firearm accessory designed to launch explosives (Category 10)

a. **Description, quantity, capabilities, and purchase cost:**

NONE

b. **Purpose:**

N/A

c. **Authorized Use:**

N/A

d. **Expected Lifespan:**

N/A

e. **Fiscal Impact:**

N/A

10. Noise Flash Diversionary Device (Flashbangs) (Category 11)

a. **Description, quantity, capabilities, and purchase cost:**

A Noise Flash Diversionary Device (NFDD) is a device that creates a bright flash and loud sound to temporarily divert the attention of subjects in the immediate area. NFDDs are used to distract and temporarily disorient dangerous suspects by overwhelming their senses of vision and hearing. The distraction allows officers to seize a moment of opportunity to take control of high-risk situations.

- I. NFDD Defense Technology 8901SC emits a loud “bang” and a flash of light.
Quantity: 50

b. **Purpose:**

A distraction device is ideal for distracting dangerous suspects during assaults, hostage rescue, room entry or other high-risk arrest situations. To produce atmospheric over-pressure and brilliant white light and, as a result, can cause short-term (6 - 8 seconds) physiological/psychological, sensory deprivation to give officers a tactical advantage.

c. **Authorized Use:**

Diversionary Devices shall only be used:

- I. During encounters with self-destructive, violent, dangerous and/or combative subjects.
- II. By ERT officers who have been trained in their proper use in accordance with POST guidelines and received annual training by a POST-certified instructor.
- III. Circumstances where the Emergency Response Team members can obtain tactical advantage during the following critical incidents: Barricaded violent felony suspect, vehicle barricade of a felony suspect, active shooter, or a hostage rescue operation.
- IV. During department-approved training exercises.
- V. NFDDs shall not be used for crowd dispersal.
- VI. All uses of NFDDs must first be approved by a Bureau Captain.
- VII. In compliance with department policy (705 Noise Flash Diversionary Devices) as well as federal, state, and local laws and ordinances.

d. **Expected Lifespan:**

NFDD Defense Technology 8901SC - 5 years

e. **Fiscal Impact:**

NFDD Defense Technology 8901SC – annual cost approximately \$283.00

11. Tear Gas (Category 12)

a. **Description, quantity, capabilities, and purchase cost:**

Chemical agent munitions, which are commonly referred to as “tear gas,” are used by the Culver City Police Department as a non-lethal tool to disperse violent suspect(s) and/or on a felony barricaded suspect(s) to cause barricaded suspects to exit the barricaded structure/location. All chemical agents will be used only in compliance with Penal Code section 13652 and Government Code Section 12525.2.

The Culver City Police Department uses chemical agents which are used by law enforcement across the United States: CS (2-Chlorobenzylidenemalononitrile) and OC (Oleoresin Capsicum).

CS is an irritating agent and lachrymator that irritates the eyes and causes tears to flow. CS has been medically tested in the U.K. and U.S., specifically by the U.S. Army. There are no known allergic reactions to CS.

OC was de-regulated in California in 1996, is endorsed by the FBI, and is available to civilians to legally possess (2.5oz or less). OC is an inflammatory agent which causes involuntary closure of eyes for a duration of 2 to 5 minutes and respiratory inflammation, which subsides in approximately 2 minutes.

- I. CTS Combined Tactical Systems 5230B - Pyrotechnic grenade designed for indoor use delivering a maximum amount of irritant smoke throughout multiple rooms with minimal risk of fire. Quantity: 18
- II. Defense Technology Spede-Heat™ - 40mm short-range CS round incorporates an aluminum shell and utilizes black powder as the propellant. The Spede- Heat™ 40mm short-range round is designed to deliver one dual-ported chemical canister from a 40mm launcher 75 yards to the intended target zone. Quantity: 15
- III. Defense Technology Pocket Tactical – pyrotechnic grenade that is designed as a signaling or covering device. Quantity: 2

b. **Purpose:**

To act as, and shall be limited to, a de-escalation and less lethal option during the following situations:

- I. Self-destructive, dangerous, violent, and/or physically combative individuals.
- II. Violent riotous crowd control incidents when such weapons are necessary to defend against a threat to life or serious bodily injury to any individual, including a peace officer, or to bring a violent, dangerous and unlawful situation safely and effectively under control. Tear gas shall not be used against individuals or groups who merely fail to disperse or do not reasonably appear to present a risk to the safety of officers or the public.
- III. Circumstances where members of the Emergency Response Team can obtain a tactical advantage during the following critical incidents: Barricaded violent felony suspect, vehicle barricade of a felony suspect, active shooter, or a hostage rescue operation.
- IV. Potentially vicious animals.
- V. Department-approved training exercises

- c. **Authorized Use:**
 - I. Chemical Agents shall only be used by officers who have received POST certification in the use of chemical agents and in a manner consistent with Department policy.
 - II. Use of chemical agents for the dispersal of riotous crowds must first be approved by the Chief of Police.
 - III. All other approved use of tear gas must first be approved by a Bureau Captain.
 - IV. During department-approved training exercises
 - V. In compliance with Department Policies 350, (Control Devices/Chemical Agents) and 300 (Use of Force) as well as federal, state, and local laws and ordinances.

 - d. **Expected Lifespan:**
 - I. CTS Combined Tactical Systems 5230B - 5 years
 - II. Defense Technology Spede-Heat™ - 5 years
 - III. Defense Technology Pocket Tactical – 5 years

 - e. **Fiscal Impact:**
 - I. CTS Combined Tactical Systems 5230B - annual cost between \$0 and \$360.00
 - II. Defense Technology Spede-Heat™ - annual cost between \$0 and \$346.00
 - III. Defense Technology Pocket Tactical - annual cost between \$0 and \$250.00
12. PepperBall Launcher (Category 12)
- a. **Description, quantity, capabilities, and purchase cost:**
A system that uses high-pressure air to deliver PAVA powder projectiles (similar to a paintball delivery system). This system can launch projectiles at a subject up to 60'. In addition, the system is capable of area saturation up to 150'. Non-lethal option offers law enforcement officers to deliver chemical agents and kinetic energy impacts to subjects in a potentially violent encounter. De-Escalation tools are used to avoid further injuries or lethal options on a subject.
 - I. PepperBall TAC-SA™ Launcher – a semi-automatic platform that can fire multiple projectiles over expansive areas. Quantity: 4
 - II. Byrna SD Pepper Ball Launcher – semi-automatic (pistol-style) platform that can fire multiple projectiles. Quantity: 3
 - III. PepperBall Live Projectile - designed for direct impact and area saturation, especially in confined, interior spaces. The projectile has a direct impact of 30 ft and an area of saturation of 150+ft. The projectile contains 0.5% PAVA Powder. Quantity: 1500 rounds
 - IV. PepperBall Live-X Projectile - contains approximately 10x the PAVA of the Live projectile. This projectile is designed for direct impact or area saturation. The projectile has a direct impact of 60 ft and an area of saturation of 150+ft. The projectile contains 5% PAVA powder. Quantity: 3000 rounds

 - b. **Purpose:**
To act as, and shall be limited to, a de-escalation and less lethal option during the following situations:
 - I. Self-destructive, violent, dangerous and/or combative individuals.
 - II. Riot/crowd control and civil unrest incidents when such weapons are deemed necessary to defend against a threat to life or serious bodily injury to any individual, including a peace officer, or to bring an objectively dangerous and unlawful situation safely and effectively under control.

- III. Potentially vicious animals.
- IV. Department-approved training exercises.

c. **Authorized Use:**

- I. Only by officers who have been trained in the use of PepperBall Launchers, in a manner consistent with Department policy, are authorized to use PepperBall Launchers.
- II. Deployment and use of the PepperBall launcher must first be approved by the on-duty Watch Commander or the on-scene Field Supervisor.
- III. Use of the PepperBall launcher for dispersal of riotous crowds must first be approved by the Chief of Police.
- VI. In compliance with Department Policies 304, (Control Devices-Impact Weapons), 350 (Control Devices -Chemical Agents), and 300 (Use of Force) as well as federal, state, and local laws and ordinances.

d. **Expected Lifespan:**

- I. PepperBall TAC-SA™ Launcher - No expiration
- II. Byrna SD Pepper Ball Launcher - No expiration
- III. Live Projectile - 1 year
- IV. Live-X Projectile - 1 year

e. **Fiscal Impact:**

- I. PepperBall TAC-SA™ Launcher - No annual cost unless replacement purchases are necessary (Purchase price: \$1,599.95)
- II. Byrna SD Pepper Ball Launcher – No annual cost unless replacement purchases are necessary (Purchase price: \$349.00)
- III. Live Projectile – annual cost approximately \$1,928.00
- IV. Live-X Projectile – annual cost approximately \$1,928.00

13. Taser Shockwave, microwave weapons, water cannons, and the Long-Range Acoustic Device (LRAD) (Category 13)

a. **Description, quantity, capabilities, and purchase cost:**

NONE

b. **Purpose:**

N/A

c. **Authorized Use:**

N/A

d. **Expected Lifespan:**

N/A

e. **Fiscal Impact:**

N/A

14. Projectile Launch platforms and associated munitions (Category 14)

a. **Description, quantity, capabilities, and purchase cost:**

The Projectile Launcher is not a firearm, but a Less-Lethal system that uses smokeless powder to deliver 40MM projectiles from a safe distance. The Less-Lethal launcher is capable of launching 40MM munitions at a subject up to 25 yards.

- I. B&T GL06 40MM Launcher, Quantity: 2
- II. Defense Technology Model 40 Launcher, Quantity: 6

- III. Defense Technology 6325 (Sponge Round) Projectile - 40mm direct-fire round has a plastic body and sponge nose designed for crowd control, patrol, and tactical applications.
- IV. Defense Technology OC Crushable Projectile – 40 mm short-range round is a direct-fire munition that is designed to emit an irritant powder upon impact. Quantity: 26
- V. Defense Technology 6297 Projectile – contains 60-caliber rubber balls designed for crowd management

b. **Purpose:**

To act as, and shall be limited to, a de-escalation and less lethal option during the following situations:

- I. Self-destructive, violent, dangerous and/or combative individuals.
- II. Riot/crowd control and civil unrest incidents when such weapons are deemed necessary to defend against a threat to life or serious bodily injury to any individual, including a peace officer, or to bring an objectively dangerous and unlawful situation safely and effectively under control.
- III. Potentially vicious animals.
- IV. Department-approved training exercises.

c. **Authorized Use:**

- I. Only those officers who have been trained in the use of Projectile Launchers are authorized to use the Projectile Launchers, in a manner consistent with Department policy.
- II. Use for dispersal of riotous crowds must first be approved by the Chief of Police
- III. All other use of Projectile Launchers must first be approved by the on-duty Watch Commander or the on-scene Field Supervisor.
- IV. In compliance with Department Policies 304, (Control Devices-Impact Weapons) and 300 (Use of Force) as well as federal, state, and local laws and ordinances.

d. **Expected Lifespan:**

- I. B&T GL06 40MM Launcher - No expiration
- II. Defense Technology Model 40 Launcher - No expiration
- III. Defense Technology 6325 (Sponge Round) Projectile – 5 years
- IV. Defense Technology OC Crushable Projectile - 5 years
- V. Defense Technology 6297 Projectile – 5 years

e. **Fiscal Impact:**

- I. B&T GL06 40MM Launcher – No annual cost unless replacement purchases are necessary (Purchase price: \$1,375.00)
- II. Defense Technology Model 40 Launcher – No annual cost unless replacement purchases are necessary (Purchase price: \$805.00)
- III. Defense Technology 6325 (Sponge Round) Projectile – annual cost approximately \$2,650 [per quantity]
- IV. Defense Technology OC Crushable Projectile – annual cost approximately \$265.00 [per quantity]
- V. Defense Technology 6297 Projectile-annual cost approximately \$22.00 [per quantity]

MILITARY EQUIPMENT NOT OWNED BY DEPARTMENT SUBJECT TO COLLABORATIVE USE (Equipment Category 15)

The purpose of this section is to identify any defined military equipment that could possibly be used in Culver City, by a neighboring law enforcement agency, during a critical incident. Such critical incidents should be limited to high-risk search warrant operations, barricaded felony suspect, active shooter, bomb threat/suspicious package, or joint training exercise. Note that the below-described equipment is not owned by the Department or operated by Culver City Police Department personnel.

2. Robot (Category 1)

a. **Description, quantity, capabilities, and purchase cost:**

A remotely controlled unmanned machine that operates the ground, which is utilized to enhance the safety of the community and officers. This device can be remotely operated from many hundred meters away, providing protection and safety to their operators. There is no cost to the Culver City Police Department for a neighboring agency use in this jurisdiction.

b. **Purpose:**

To be used to remotely gain visual/audio data, deliver CNT phone, open doors, disrupt packages, and clear buildings.

c. **Authorized Use:**

- V. Only by a neighboring police agency in accordance with their existing policies and procedures.
- VI. Approval to use a robot in Culver City, or in collaboration with the Culver City Police Department, must first be approved by a Bureau Captain and only during critical incidents
- VII. During Department-approved training exercises.

d. **Expected Lifespan:**

N/A

e. **Fiscal Impact:**

N/A

3. Armored Personnel Carrier (Category 2 &3)

a. **Description, quantity, capabilities, and purchase cost:**

An armored vehicle that seats 10-12 personnel with an open floor plan that allows for rescue of down personnel. It can stop various projectiles, which provides greater safety to citizens and officers beyond the protection level of a shield and personal body armor.

b. **Purpose:**

To be used in response to critical incidents to enhance officer and community safety, improve scene containment and stabilization, and assist in resolving critical incidents.

c. **Authorized Use:**

- I. Only by a neighboring police agency in accordance with their existing policies and procedures.
- II. Approval to deploy an Armored Personnel Carrier in Culver City, or in collaboration with the Culver City Police Department, must first be approved by a Bureau Captain and only during critical incidents
- III. During Department-approved training exercises.

d. **Expected Lifespan:**

N/A

e. **Fiscal Impact:**

N/A



Technical Specifications

B&T GL-06

Single Shot Launcher cal. 40 x 46 mm
manufactured by B&T AG, Switzerland



TS-2889.17

B&T AG
P.O. Box 174 • 3608 Thun
Switzerland
Fon +41 33 334 67 00
Fax +41 33 334 67 01
info@bt-ag.ch
www.bt-ag.ch

Technical Specifications GL-06



Table of Contents:

1. General description	3
2. Nomenclature and technical data	4
3. Operating principle	5
4. Compatible ammunitions	7
5. Ballistic data	8
6. Exploded view and parts list	9
7. Accessories	11
7.1 Tactical	11
7.2 Training	12
7.3 Maintenance	12
8. Manufacturer's warranty information	13

Related documents

TM-2889 Operator Manual
SM-2889 Armorer Manual
TR-2889-1 Qualification Test Report
PC-2889 Parts Catalogue

Abbreviations:

HE: High Explosive. Warhead grenades, working at high pressure level.
LL: Less lethal. Munitions working at pressure levels 4 to 5 times lower than HE grenades.



1. General description

The GL-06 grenade launcher is intended to serve as a supplemental or squad weapon with less lethal munitions for all types of crowd management and law enforcement tasks.

The GL-06 is designed as a single shot break down weapon. Due to its design and strength of materials, the launcher works with all kind of 40 x 46 mm ammunitions. The trigger is of double-action-only style with non-exposed hammer for safe and simple operation.

There are different stock configurations, integrated NATO accessory rails and the possibility to install more rails and accessories to optimize the launcher specifically to each mission.

The ergonomics are state of the art: red dot sight for fast and accurate target acquisition, left and right side sling attachment points, large ambidextrous operating elements and a wide trigger guard for easy operation even with heavy protective gloves.

2. Nomenclature and technical data



Fig. 2.1

Designation:	GL-06	
Manufacturer:	B&T AG, Switzerland	
Product ID:	BT-31000 black without access safety BT-31000-1 black with access safety BT-31000-2 yellow (RAL 1021) without access safety BT-31000-3 yellow (RAL 1021) with access safety	
NATO Stock Number:	1010-38-000-9860	
Caliber:	40 x 46 mm	
System:	Break-down single shot, double action only	
Barrel length [mm]:	280	
Twist rate [mm per turn]:	1200	
Rifling:	12 grooves, right hand	
Overall length [mm]:	590 (stock unfolded)	385 (stock folded)
Overall width [mm]:	60 (stock unfolded)	95 (stock folded)
Overall height [mm]:	200	
Weight [kg]:	2.15	
Sights:	Red dot sight Aimpoint Micro T-1 (dot size 4 MOA) Ghost ring iron sights (sight radius 339 mm), adj. in windage	
Interfaces:	4 NATO accessory rails STANAG 4694	
Standard supply:	Weapon complete with siderails, rail covers and carrying sling	

3. Operating principle

When the weapon is closed, the locking lug under the barrel is held in position by the two locking latches and the barrel is locked (ref. fig. 3.1). When pushing the breech lever forward, a rising wedge is spreading the two latches like a couple of shears, releasing the locking lug and thus unlocking the barrel (fig. 3.1). By the force of the barrel spring, the barrel snaps open and can be loaded manually.

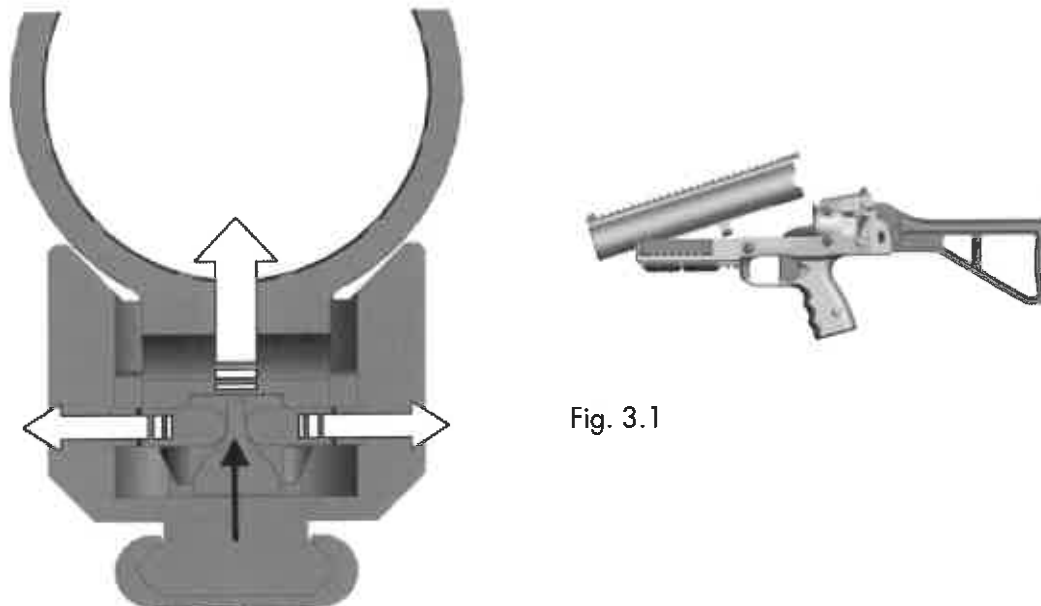

Fig. 3.1

When the launcher is loaded, the operator can release the shot simply by pulling the double action only trigger (fig. 3.2). The firing pin (part of the hammer) touches the primer of the cartridge only when the trigger releases the covert hammer, then it snaps immediately back in a safe position.



Fig. 3.2

In order to increase the operational safety of the launcher, a manual push-through safety is available which locks the hammer with the firing pin in safe distance of the primer.

Some comments about the operating principle of 40 x 46 mm grenades: Unlike conventional small arms cartridges, the case shows two chambers (see fig. 3.3). When the firing pin strikes on the primer, it ignites the propellant which is in the inner high pressure chamber. The combustion gases are then released by diffusers into the outer low pressure chamber. It is the force of the gases in the low pressure chamber which drive the projectile, which is set on top of this named chamber, through the barrel.

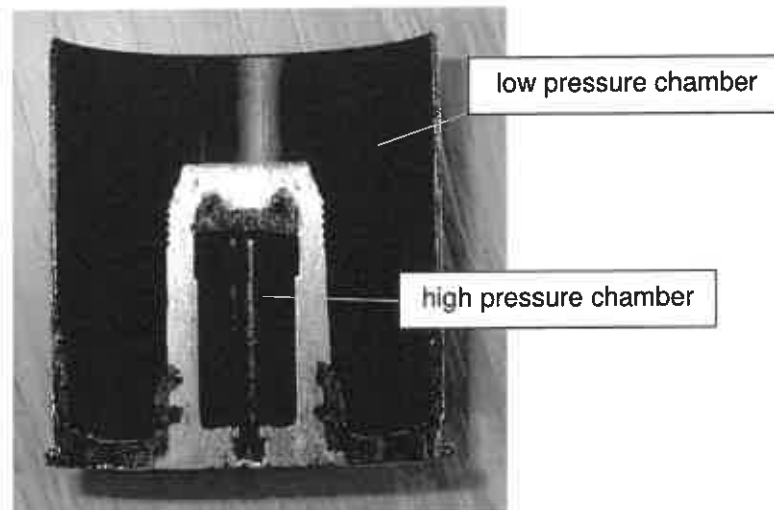

Fig. 3.3: Cut through fired 40 x 46 mm grenade

Concerning internal ballistics, recoil, mechanical stress on the weapon and quality control of the grenades, it is always the maximum pressure in the outer low pressure chamber to consider.

40 x 46 mm ammunitions exist in two distinctive qualities: One is warhead (HE) grenades with a payload of around 200 grams - typically an explosive projectile - and working with low chamber pressures of approx. 200 bar. The other is less lethal (LL) munitions with low mass kinetic energy projectiles or a chemical agent as payload; their working pressure is around four times lower than with HE grenades.

The GL-06 is designed for use with LL munitions but strong enough to withstand the pressure of a HE grenade.

4. Compatible ammunitions

Compatibility is limited by dimensions and maximum pressures. The critical dimensions are outlined in fig. 4.1. Note that the cartridge overall length is of no importance: 40 x 46 mm munitions of any length can be loaded in the GL-06.

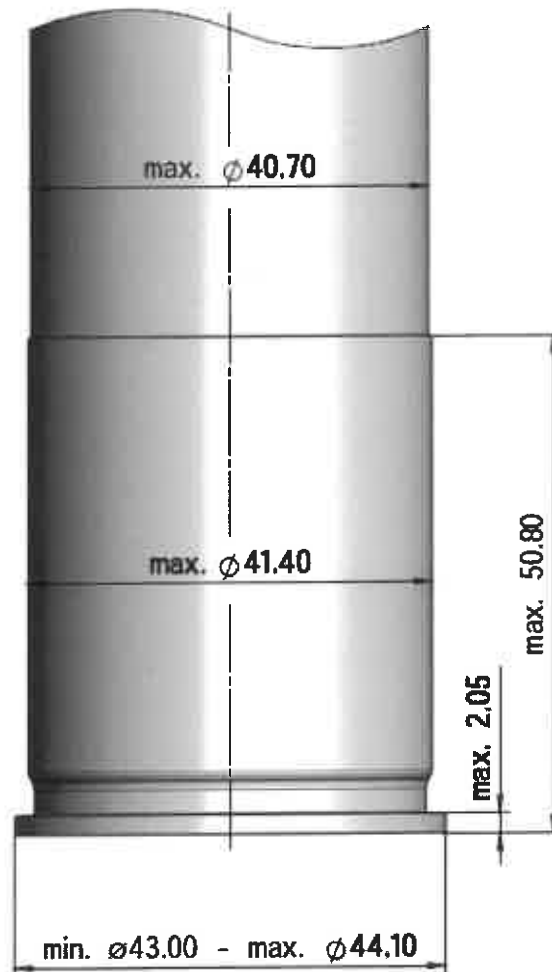

Fig. 4.1: Compatible dimensions

Regarding the pressure compatibility, the maximum pressure in the low pressure chamber at extreme service conditions (ESCP) is to consider. ESCP is the most dangerous conform condition of ammunition (according to ammo manufacturer specs), e.g. after 24 h high temperature storage.

In an inspection lot of ten cartridges, the average (m) and the standard deviation (s) of ESCP must comply with

$$m_{\text{ESCP}} + 2.91 \cdot s_{\text{ESCP}} \leq 230 \text{ bar}$$

5. Ballistic data

The sights of the GL-06 launcher are set point blank to 25 m with SIR 40 mm (B&T BT-23510); ballistic data below.

x [m]	v [m/s]	E [J]	ED [J/mm ²]	t [s]	dia _{0,99} [mm]
0	85	116	0.092	0.00	0
5	84	112	0.089	0.06	29
10	82	109	0.087	0.12	59
15	81	106	0.084	0.18	90
20	80	102	0.082	0.24	121
25	79	99	0.079	0.31	152
30	78	97	0.077	0.37	184
35	77	94	0.075	0.43	217
40	75	91	0.072	0.50	250
45	74	88	0.070	0.57	283
50	73	86	0.068	0.64	317

Table 5.1: Ballistic data of SIR impact round (projectile mass 32 grams)

x: Distance

v: Velocity

E: Kinetic energy

ED: Energy density

t: Flight time

dia_{0,99}: Diameter of circular target with hit probability of 99%

6. Exploded view and parts list

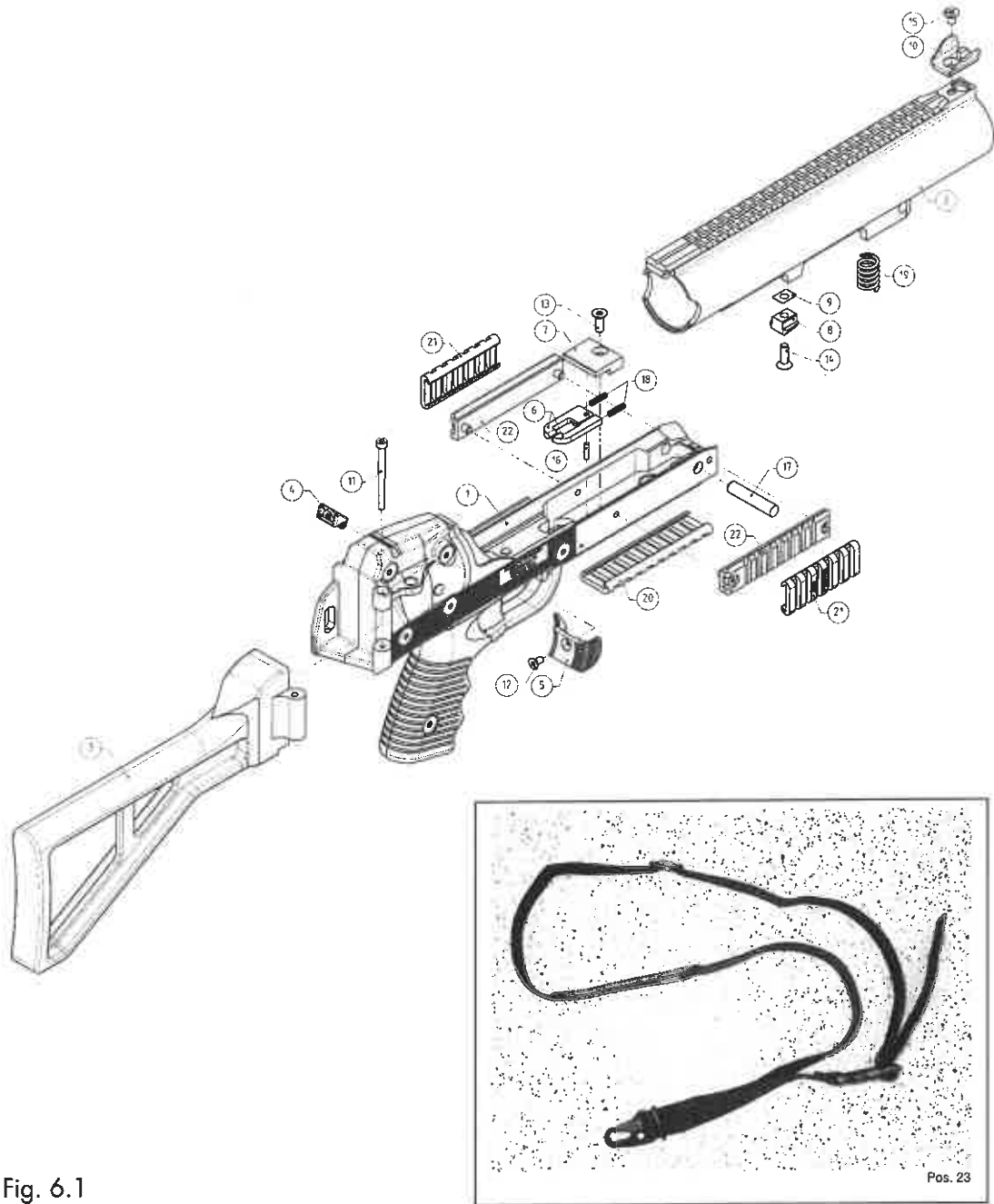

Fig. 6.1

Technical Specifications GL-06



Pos.	Designation	Part Number
1	Main assembly (for BT-31000 or BT-31000-1)	BT-31047
2	Barrel (only)	BT-31010
3	Folding stock complete	BT-20218
4	Rear sight assembly	BT-30223
5	Breech lever	BT-31012
6	Locking latches (left/right identical, two per weapon)	BT-31020
7	Locking latch retainer	BT-31022
8	Locking lug	BT-31013
9	Spacer (if necessary)	BT-31029
10	Front sight	BT-31008
11	Folding stock axle screw	BT-31031
12	Breech lever screw	BT-31032
13	Retainer screw	BT-31035
14	Locking lug screw	BT-31036
15	Front sight screw	BT-31033
16	Locking latch axle pin	BT-31040
17	Breech axle pin	BT-31043
18	Locking latch springs (two per weapon)	BT-31067
19	Barrel spring	BT-31049
20	Rail protector	BT-21204-3
21	Side rail protectors (two per weapon)	BT-21204-4
22	Side rails with screws (two per weapon)	BT-21731
23	Sling	BT-400967-1

For more details refer to parts catalogue PC-2889.

7. Accessories

7.1 Tactical



Pos.	Description	Product ID
1	B&T quick detachable vertical handgrip	BT-21773
1α	B&T screw-on vertical handgrip NSN 1005-17-117-0959	BT-21203
2	B&T foldable ballistic helmet visor stock	BT-20222

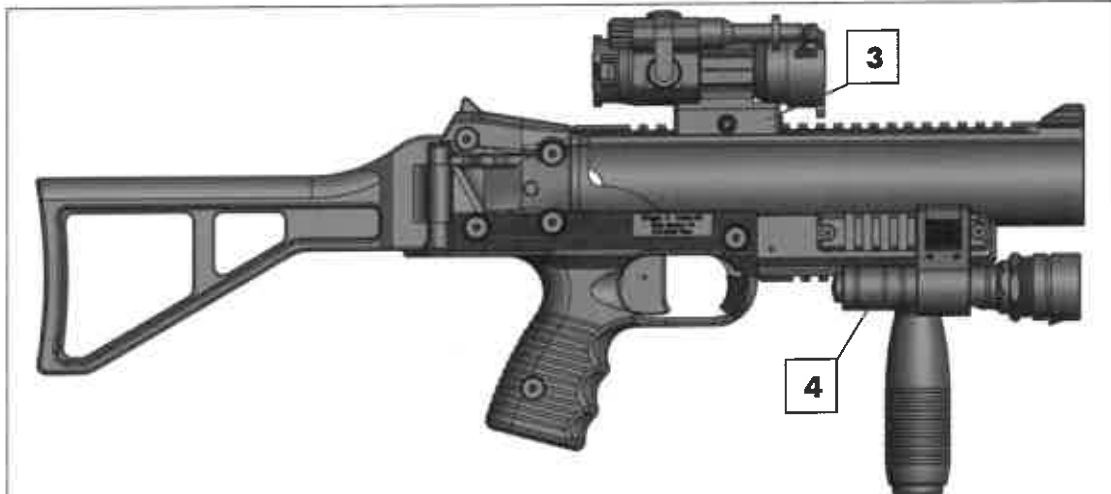

Pos.	Description	Product ID
3	B&T quick detachable mounts for optical sights	various
4	B&T tactical light 6 V	BT-211017
	B&T tactical light 9 V	BT-211016
	B&T tactical light 6 V IR	BT-21803

B&T carrying bag for 1 launcher and 20 cartridges	tbd
---	-----

byrnaHD

SPECIFICATIONS

Model Number:	HD68300
Size:	7.28" X 5.62" 185mm X 143mm
Loaded Weight:	1.3lb 597g
Housing Materials:	Glass-filled Nylon Rubber Overmold Grip
Component Materials:	Aluminum and Stainless Steel
Caliber:	.68
Speed of Projectile:	220-300 FPS
Weight of Projectile:	3.2 Grams
Force at Muzzle Velocity:	13 Joules
Composition of Chemical Rounds:	Byrna HD Max - 12% active ingredients: OC, CS, and PAVA Byrna HD Pepper - 5% OC
Magazine Capacity:	5 Rounds
Propulsion:	One (1) 8 Gram CO ₂ Cartridge
Puncture Mechanism:	Punctures CO ₂ Cartridge and fires first projectile all with first trigger pull.
Temperature Range, Effective Use:	0° F - 120° F -18° C - 49° C
Accessories:	Laser Pointers, Flashlights, Holsters (left and right hand carry)
Safety Lever:	Ambidextrous
Colors:	Safety Orange, Bright Yellow, Gray, Desert Tan, Black

Patents Pending

MODEL No.	DESCRIPTION:
5210B	Smoke Baffled Canister Grenade, Low Flame Potential
5220B	CN Baffled Canister Grenade, Low Flame Potential
5230B	CS Baffled Canister Grenade, Low Flame Potential
Revision D 5/21	



NOT TO SCALE

WARNING: CSI manufactures a variety of CTS less lethal products which are under pressure, pyrotechnic, incendiary, emit projectiles, generate smoke, or are explosive in nature. When used in accordance with CTS training guidelines and the individual agency's policy, they are intended to cause varying degrees of pain and injury, which are temporary. These products are restricted to law enforcement, corrections, and military personnel and are used to gain compliance, disperse crowds, restore order, or temporarily incapacitate dangerous persons. In rare circumstances, if used incorrectly, CTS less-lethal products may cause damage to property, serious bodily injury or death. Therefore, any person using the force option depicted on this page should receive proper training to ensure the safest and most effective use.

PHYSICAL & OPERATIONAL

Type	Irritant & Smoke Pyrotechnic Grenades
Diameter	2.60" (66 mm)
Length	6.20" (157 mm)
Fuze Type	Model 201
Fuze Delay	1.5 +/- 0.3 sec. average
Launchable	Yes
Discharge Time	20 - 40 Seconds
Emission Ports	4
Overall Weight	395 gm
Warranty	5 Years From Shipment Date

All specifications are average and are subject to change without notice.
All performance specifications are based on testing conducted in Jamestown, PA USA,
At an elevation of 1,058 feet above sea level at ambient temperature conditions.

SHIPPING INFORMATION

Proper Shipping Name	Ammunition, Smoke
UN Number	0303
Hazard Class	1.4G
Labels Required	Explosive 1.4G
Quantity Per Package	24 Grenades
Total Package Weight	31 lb.
Package Type	UN Specification 1A2/Y36/S Metal Drum with Lever Lock Lid
Package Dimensions	19x12 (7 gal. drum also used for overnight packages)



All DD5 rifles feature Superior 4-Bolt Bolt Carrier Group, which are used to connect and attach. The patent pending bolt carrier buffer optimizes cycling.



All DD5 rifles include the innovative 4-Bolt Connection System securely attaches free-floating CHF barrel and handguard mounts securely to upper without a barrel nut.



Innovative 4-Bolt Connection System replaces barrel nut for increased stability and a uniform connection between the handguard, barrel, and receiver.

18" chrome-lined, heavy-phosphate-coated Strength-to-Weight-profile barrel for accuracy and extended range.

Independently ambi GRIP-N-RIP charging handle has anti gas features for a better shooting experience.

The DD5 V4, chambered in either 6.5 Creedmoor or 7.62x51mm NATO, provides users of the Daniel Defense semi-automatic platform even greater long range precision shooting capability. The highly popular 6.5 Creedmoor takes advantage of superior ballistic coefficients to offer both flatter trajectories and reduced wind drift at levels normally reserved for much heavier recoiling long action calibers.

NEW DD5.V4.





**DEFENSE
TECHNOLOGY®**

DISTRACTION DEVICE® RELOAD W/ SC 12-GRAM

PRODUCT SPECIFICATIONS	
Reload	Steel collar w/ cardboard tube
Diameter	0.78 in / 1.98 cm
Length	5.00 in / 12.7 cm
Canister	To be used with reloadable bodies
Fuze	M201A1 Type
Explosive Content	Flash Powder - 0.42 oz / 12 grams
Sound Level	175 dB at 5' (1.5m)
Light Level	6 – 8 million Candelas
Light Duration	10 milliseconds
Part No.	8901SC 8901SC-HH
Warranty	5 years from date of manufacture

ALL SPECIFICATIONS ARE AVERAGES AND SUBJECT TO CHANGE

The 12-Gram Distraction Device® Reload w/ Safety Clip utilizes an M201A1 type fuze that was designed for use with the Distraction Device reloadable steel body. The safety clip is designed to keep the pull-pin against the device body to prevent the pin from protruding and possibly snagging on other objects. The 12-Gram Distraction Device Reload w/ Safety Clip is only to be used when properly inserted and tightened into the Distraction Device body. **DO NOT** discharge the reload without the use of the steel body. The Distraction Device body should only be deployed in areas that have been visually observed to be clear of potential hazards. It is recommended that the immediate area for deployment be visually affirmed to be clear of personnel and that the device is delivered so that the ports are free from obstruction. If the bottom port is obstructed by an object or wall, the device body may move. The cleared area for deployment should be 5 - 6 feet around which the device is expected to come to rest.

A modified version of the 12-Gram Distraction Device Reload w/ Safety Clip is available for use in high humidity environments that incorporates a water resistant charge tube. These products are designated by 'HH' after the part number. The standard render safe practice involving 24 hour water submersion will no longer be effective for the high humidity devices, please consult the render safe procedure for incineration in the instructions.

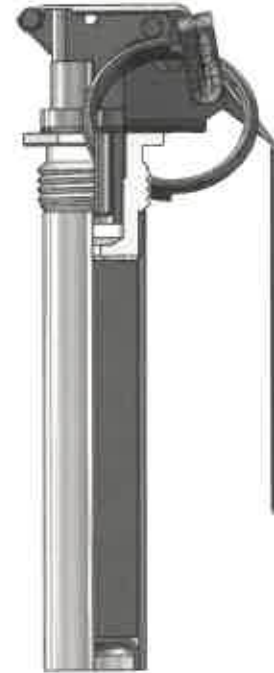

⚠ WARNING

This product can expose you to chemicals including Lead Salts and Hexavalent Chromium, which are known to the State of California to cause cancer, and Lead Salts, which are known to the State of California to cause birth defects or other reproductive harm. For more information, go to www.P65Warnings.ca.gov.

WARNING: TO BE USED BY TRAINED LAW ENFORCEMENT, CORRECTIONAL OR MILITARY PERSONNEL WHO HAVE SUCCESSFULLY COMPLETED A TRAINING PROGRAM FOR THE DEPLOYMENT OF DISTRACTION DEVICE® UNITS. IMPROPER USE OF THE DISTRACTION DEVICE UNIT CAN RESULT IN DEATH OR SERIOUS BODILY INJURY.



INDOORS/OUTDOORS



EXPLOSIVE

1855 South Loop Casper, WY 82601

www.defense-technology.com

800.347.1200

Safariland, LLC Rev. 06/20



**DEFENSE
TECHNOLOGY®**

POCKET TACTICAL GRENADE OC, CN, CS, SAF-SMOKE™ AND COLORED SMOKE

PRODUCT SPECIFICATIONS	
Diameter	1.4 in / 3.6 cm
Length	4.75 in / 12 cm
Fuze	M201A1 Type
Active Agent	OC 0.25 oz / 7 g CN/CS 0.9 oz / 25.2 g
Discharge Time	20 – 40 Seconds
Launchable	Yes
Part No.	OC 1019 CN 1015 CS 1016 Saf-Smoke™ 1017 Saf-Smoke™ Blue 1017B Saf-Smoke™ Green 1017G Saf-Smoke™ Red 1017R Saf-Smoke™ Yellow 1017Y
Warranty	5 years from date of manufacture

ALL SPECIFICATIONS ARE AVERAGES AND SUBJECT TO CHANGE

The Pocket Tactical Grenade is a quick burning, reduced volume, continuous discharge grenade available in OC, CN, CS, and Saf-Smoke™. Pelletized chemical agent or smoke is discharged through one (1) gas port located on the bottom of the canister.

The Pocket Tactical Grenade is a small, lightweight, easily carried device that provides a medium volume of chemical agent or smoke for certain situations. It was designed with the tactical team in mind for distraction, concealment, rescue, or signaling. The pocket grenade is not specifically intended as a crowd management device; however, it can be used in chemical configurations in conjunction with larger smoke canisters to "piggy back" chemical agent into a predominately smoke environment. This device should be deployed utilizing wind advantage.

It should NOT be deployed onto rooftops, in crawl spaces, or indoors due to its fire-producing capability. Hand throw or launch. The fuze should be removed prior to inserting the grenade into the launching cup, and then the open threaded end is inserted into the launching cup first. Launching of grenades will provide deploying officers additional standoff distances. This small canister affords good coverage and may also be used as a distraction device.

It may also be used as a distraction to focus attention away from other activities.

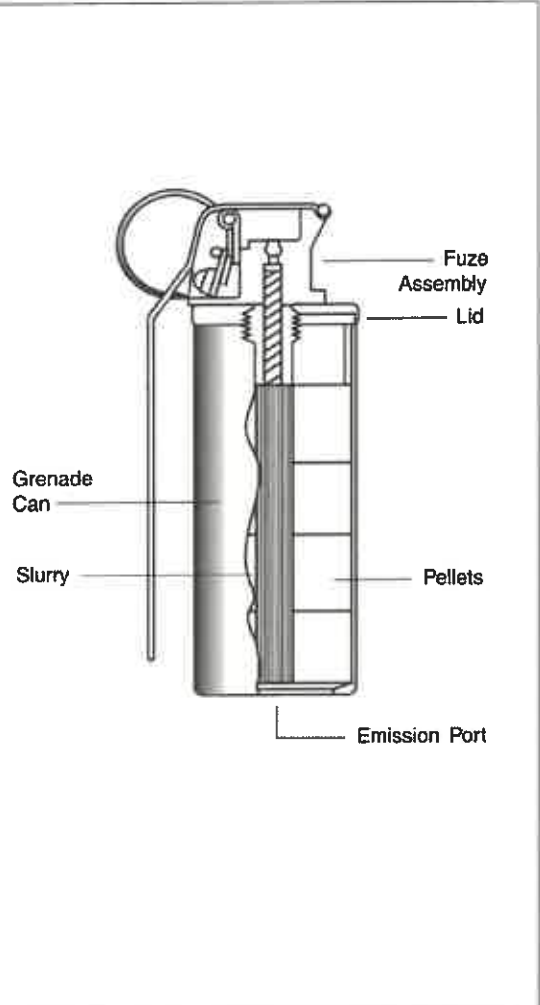

⚠ WARNING

This product can expose you to chemicals including Lead Salts and Hexavalent Chromium, which are known to the State of California to cause cancer, and Lead Salts, which are known to the State of California to cause birth defects or other reproductive harm. For more information, go to www.P65Warnings.ca.gov.

WARNING: THIS PRODUCT IS TO BE USED ONLY BY AUTHORIZED AND TRAINED LAW ENFORCEMENT, CORRECTIONS, OR MILITARY PERSONNEL. THIS PRODUCT MAY CAUSE SERIOUS INJURY OR DEATH TO YOU OR OTHERS. THIS PRODUCT MAY CAUSE SERIOUS DAMAGE TO PROPERTY. HANDLE, STORE AND USE WITH EXTREME CARE AND CAUTION. USE ONLY AS INSTRUCTED.



OUTDOORS



BURNING



PYROTECHNIC

SPEDE-HEAT™ GRENADE CONTINUOUS DISCHARGE OC, CN AND CS



**DEFENSE
TECHNOLOGY®**

PRODUCT SPECIFICATIONS	
Diameter	2.62 in / 6.7 cm
Length	6.12 in / 15.5 cm
Fuze	M201A1 Type
Active Agent	OC 1.09 oz / 31 g CN/CS 2.9 oz / 81.2 g
Discharge Time	20 – 40 Seconds
Launchable	Yes
Part No.	OC 1070 CN 1071 CS 1072 Smoke See Max. Smoke #1073
Warranty	5 years from date of manufacture

ALL SPECIFICATIONS ARE AVERAGES AND SUBJECT TO CHANGE

The Spede-Heat™ Grenade is a high volume, continuous discharge grenade available in OC, CN or CS.

In the OC, CN and CS configurations, pelletized chemical agent is discharged through four (4) gas ports located on top of the canister, three (3) on the side, and one (1) on the bottom.

Designed specifically for outdoor use in crowd control situations, the Spede-Heat™ Grenade is built on the old style larger canister. It is a high volume continuous burn device that expels its payload in approximately 20 - 40 seconds from a single source. The longer burn time may allow for throwback by individuals wearing burn protection such as a welder's mitt. The canisters may be protected from advancing individuals with the use of less lethal impact munitions. The device should be deployed utilizing wind advantage.

It should NOT be deployed onto rooftops, in crawl spaces, or indoors due to its fire-producing capability. Hand throw or launch. Launching of grenades will provide deploying officers additional stand-off distances. Affords very good coverage for large outdoor areas.

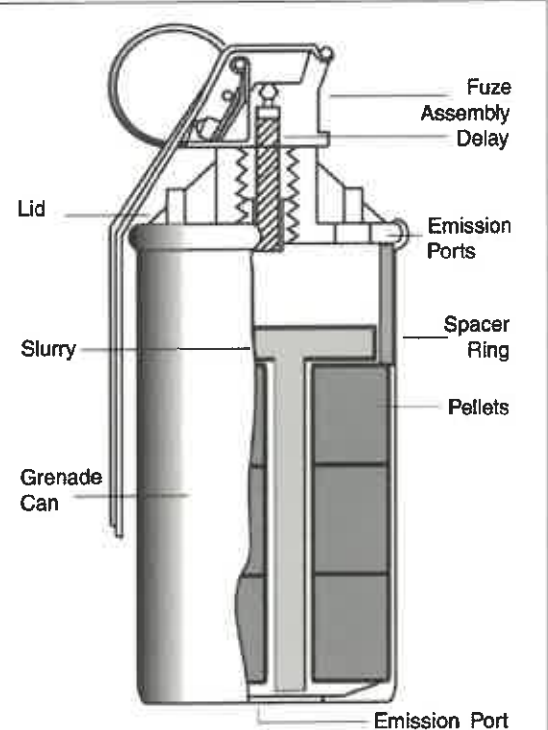

⚠ WARNING

This product can expose you to chemicals including Lead Salts and Hexavalent Chromium, which are known to the State of California to cause cancer, and Lead Salts, which are known to the State of California to cause birth defects or other reproductive harm. For more information, go to www.P65Warnings.ca.gov.

WARNING: THIS PRODUCT IS TO BE USED ONLY BY AUTHORIZED AND TRAINED LAW ENFORCEMENT, CORRECTIONS, OR MILITARY PERSONNEL. THIS PRODUCT MAY CAUSE SERIOUS INJURY OR DEATH TO YOU OR OTHERS. THIS PRODUCT MAY CAUSE SERIOUS DAMAGE TO PROPERTY. HANDLE, STORE AND USE WITH EXTREME CARE AND CAUTION. USE ONLY AS INSTRUCTED.





Bullet: 75 gr. BTHP T2 TAP®
B.C.I.: .355 S.D.: .214
Muzzle Velocity: 2858 fps
Barrel: 16"
Twist Rate: 1:9"
Total Penetration: 10.5"
Max. Cavity: 5.5"
Depth to Max. Cav.: 5.5"
Entry: 0.75"
Retained Weight: 31.5 gr.



75gr. BTHP T2 TAP® ITEM #8126N

APPLICATION: PRECISION RIFLE

The T2 bullet profile is specifically designed to optimize function and feeding in M16/M4 variant guns. The cartridge's propellant technology is custom designed to enhance weapon operation, and delivers phenomenal temperature stability. The 75 gr. BTHP T2 bullet is designed to deliver rapid incapacitation upon impact.

75 gr. BTHP T2 TAP® 16" barrel DPMS Arms	muzzle	100 yds.	200 yds.	300 yds.	400 yds.	500 yds.
Velocity (fps)	2858	2600	2357	2127	1910	1708
Energy (ft lbs)	1360	1126	925	753	608	486
Trajectory (inches)	-1.5	0	-3.7	-13.6	-31.2	-58.5



Bullet: 75 gr. TAP SBR®
G.C.I.: 230 S.D. 214
Muzzle Velocity: 2310 fps
Barrel: 10.5"
Twist Rate: 1:7"
Total Penetration: 17.0"
Max. Cavity: 4.5"
Depth to Max. Cav.: 4.5"
Entry: 0.50"
Retained Weight: 69.5 gr.



75gr. TAP SBR® ITEM #81295

APPLICATION: ENTRY, PATROL/DUTY | Meets FBI Protocol

Hornady® 5.56 NATO TAP SBR® is designed specifically for 10.5"-11.5" short-barreled rifles by using proprietary propellants and a bullet designed with technology from industry leading Critical Duty® FlexLock® bullets. TAP SBR® ammunition provides exceptional performance in suppressed or un-suppressed SBR's. With virtually no flash or residue, TAP SBR® ammunition dramatically reduces sound signature, will not foul or overheat suppressors, delivers uniform velocity and accuracy, and provides controllable rate of fire in automatic platforms. TAP SBR® is the optimum choice for 10.5"-11.5" barreled 5.56-rifles.

75 gr. TAP SBR® 10.5" barrel (1.047 Cal)	muzzle	100 yds	200 yds	300 yds	400 yds	500 yds
Velocity (fps)	2310	1964	1653	1386	1179	1042
Energy (ft lbs)	888	643	455	320	231	181
Trajectory (Inches)	-1.5	0	-7.6	-28.1	-66.8	-130.5



PROJECTILES

LIVE™

The basic PepperBall® projectile, it contains 2% PAVA, and is excellent for direct impact and area saturation, especially in confined, interior spaces.

Available Color Options:



SPECIFICATIONS

Weight	Caliber	Payload	Shelf Life	Velocity	Direct Impact	Saturation	Kinetic Impact
3g	.68	2.5g	3 Years	280-300 FPS	60ft	150+ft	8.8-11ft lb/12-15J

FEATURES

- Ultrasonically Welded
- Shell Color Indicates Payload
- 100% Waterproof
- Non-flammable
- Operational Temperature of -30°F to 150°F

FORMULA

- 2% PAVA Powder

QUANTITIES

- **Jar:** 90/375
- **Case** 1500

 **MADE IN THE USA**

U.S. Sales (877) 887-3773 | International sales + 1 (858) 228-1439 | PepperBall.com

PepperBall® is a registered trademark of United Tactical Systems, LLC, exclusive worldwide manufacturer and supplier of genuine PepperBall products.

PLE120121



PepperBall®
SAFER OPTIONS

PROJECTILES ROUND



ROUND

LIVE-X™

Our most potent and powerful concentration of PAVA pepper powder. One round of LIVE-X™ contains the equivalent PAVA irritant chemical agent in 10 regular PepperBall® LIVE™ rounds.

SPECIFICATIONS:

CALIBER

68 Caliber

PAYLOAD

2.5g

VELOCITY

280-320 FPS

FORMULA

5% PAVA Powder

WEIGHT

3g

SHELF LIFE

3 years

KINETIC

10-15J

FEATURES

- ▶ **Ultrasonically welded**
- ▶ **Shell color indicates payload**
- ▶ **100% waterproof**
- ▶ **Operational temperature of -30°F to 150°F**
- ▶ **Non-flammable**

QUANTITIES

JARS OF: 90 | 375

CARTON OF: 1500



MADE IN THE USA

PepperBall®

1-877-887-3773 | North America
+1 858-228-1439 | International

Sales@PepperBall.com
PEPPERBALL.COM

PepperBall is a registered trademark of United Tactical Systems, LLC, exclusive worldwide manufacturer and supplier of genuine PepperBall® products



IC-E IC-ENHANCED INDIVIDUAL CARBINE

5.56 NATO

BARREL	14.7" 37.3cm	16.1" 40.9cm
WEIGHTS	7.0lbs 3.2kg	7.3lbs 3.3kg
LENGTHS	30.7"-34" 78.0-86.4cm	32.1"-35.4" 81.5-89.9cm

- Monoforge™ upper receiver with integrated rail-base is stronger than the standard-pattern upper
- All LWRCI™ forgings are coined: the material is struck twice in the die for precise dimensional accuracy and a superior surface finish
- LWRCI™ Skirmish Sights
- LWRCI™ Ambidextrous Charging Handle
- Patented LWRCI™ short-stroke gas piston system offers unparalleled reliability and easy maintenance
- LWRCI™ Enhanced Fire Control Group – Nickel-Teflon coated for a smooth, crisp trigger pull with positive reset
- LWRCI™ Advanced Trigger Guard is oversized to allow for easy operation with gloves
- Black Nitride treated LWRCI™ heavy-profile barrel is precisely torqued in our factory to a consistent torque setting. Cold hammer forged 1:7 twist stabilizes a wide range of bullet types
- Nickel-Boron coated bolt carrier for unparalleled wear resistance, corrosion resistance, and permanent lubricity
- Fully-ambidextrous lower receiver controls include the bolt catch and release, the magazine release, and the safety selector
- Magpul® MOE+® Grip combines reinforced polymer body construction with comfortable wrap-around rubber overmolding for maximum weapon control in adverse environments
- LWRCI™ Compact Stock



AVAILABLE COLORS



LWRCI.COM | 410.901.1348





LAUNCHERS

TAC-SA™

The PepperBall TAC-SA semi-automatic launcher is the perfect tool for crowd management, riot-control scenarios or any other situation requiring high-intensity engagement. The TAC-SA quickly disperses PAVA across expansive areas making it a solid tool for operational teams.

Available Color Options:

Availability may be limited.



SPECIFICATIONS

Weight	Caliber	Length	Height	Action	Power	Capacity	Kinetic Impact
6.3lbs/2.8kg	.68 Caliber	28"/71.1cm	12"/30.4cm	Semi-Auto	HPA	180 Rounds	7.3-11ft lb/10-15J

FEATURES

- Uses Standard Round Projectiles
- 30ci High Pressure Air System
- Compatible with Gravity and EL-2 Hoppers
- Variable Universal ASA with ON/OFF Valve
- No Recoil
- Cross Bolt Safety
- SplitShot™ Compatible
- MIL-STD-1913 Rail Platform
- Maximum Range of 60' for Direct Impact and 150'+ for Area Saturation

U.S. Sales (877) 887-3773 | International sales + 1 (858) 228-1439 | PepperBall.com

PepperBall® is a registered trademark of United Tactical Systems, LLC, exclusive worldwide manufacturer and supplier of genuine PepperBall products.



Winchester 223 Rem (55) Sinterfire Frangible

- Symbol: **RA223SF** – Winchester Ranger Sinterfire Frangible
- Shellcase: 223 Rem brass shellcase
- Bullet: 55 grain (3.6 gram) Frangible; 100% lead free; copper/tin composite
Diameter .2241 inch (5.69 mm)
- Powder: Clean burning, low flash
- Primer: Winchester lead free, heavy metal free priming mix; nickel plated cup; boxer type
- Accuracy: Product Mean of 2.0 inches (5.1 cm) Extreme Spread
5 shot targets at 100 yards (91.4m) from a 24.0 inch (61.0 cm) SAAMI test barrel
- Velocity: 3115 ft/sec (949 m/s) nominal at 15 ft (4.6 m)
Fired in a 24.0 inch (61.0 cm) SAAMI test barrel
- Energy: 1185 ft-lb (1607 joules)
- Pressure: 55,000 psi max. average (3792 bars)
- Waterproofing: Lacquer applied to primer annulus and Black Lucas applied to mouth of case

NOMINAL DIMENSIONS SHOWN

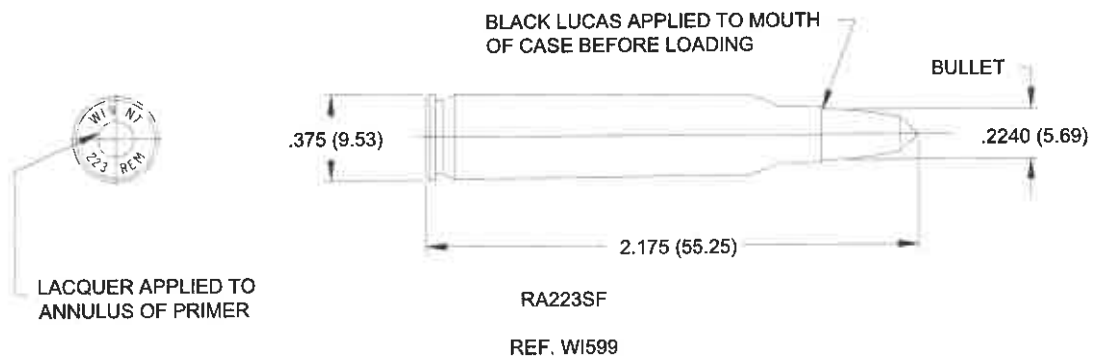

INFORMATION PUBLISHED HEREIN IS SUBJECT TO CHANGE AT MANUFACTURER'S DISCRETION WITHOUT NOTICE.

PRODUCT INFORMATION SHEET #195
Rev. D 5-25-2004

OLIN CORPORATION • WINCHESTER DIVISION • 427 NORTH SHAMROCK STREET • EAST ALTON, IL 62024-1197
TELEPHONE: 618 258-2000 • WEB SITE: www.winchester.com



**THE WORLD'S FIRST PURPOSE
BUILT TACTICAL sUAS.**

AVAILABLE FROM

SOLE SOURCE NORTH AMERICAN DISTRIBUTOR

Request a Quote

Name	Organization	City	State	Phone	Email	Submit
------	--------------	------	-------	-------	-------	--------

LOKI Mk2

Designed and built in conjunction with several of the world's top counter terrorism teams, LOKI Mk2 solves all problems associated with the tactical use of commercial UAS.

Purpose built for close quarter indoor tactical scouting missions, LOKI Mk2 features a highly sensitive Day-Night + IR sensor camera giving it the ability to fly and see in complete darkness.

Mk2 Features

- Forward-facing, .0008 lux day/night camera with 150° wide angle field of view
- On board extremely sensitive HD microphone
- Integrated flight stability/hover system using only onboard sensors
- Front and bottom selectable and dimmable IR LED's
- Turtle mode allowing the drone to automatically self-right in the event of a crash
- Integrated connector for additional payloads, sensors and actuators
- Ruggedized, user repairable cloverleaf body design

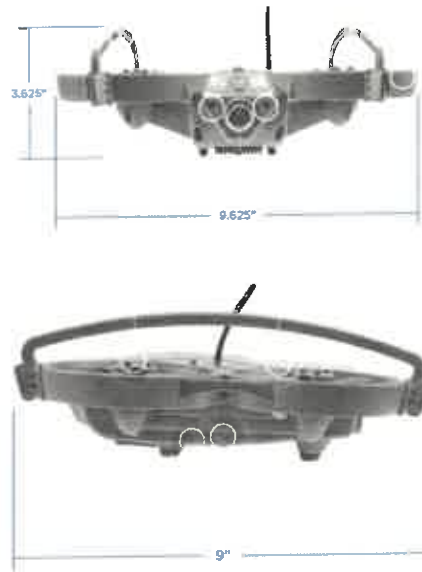

GCS Features

- Purpose-built flight controller requiring no internet service, GPS, cellular-phone or tablet
- No forced software or firmware updates providing 100% readiness
- Analog video and flight controls preventing lag and screen freezes
- AE256 control signal and scrambled video signal/relay
- Controls up to four LOKI UAS simultaneously from a single GCS
- Ergonomic and compact design for intuitive flight control
- No flight training required



Request a Quote

Name: _____ Organization: _____ City: _____ State: _____ Phone: _____ Email: _____

<https://lokirest.com/loki>

00:30



What end-users are saying about the LOKI Mk2

LOKI 2.0 alone is a game changer for interior deployments. LOKI 2.0 plus a canine takes it to another level of effectiveness.

Tactical Team Leader
Los Angeles County, CA

SOLE SOURCE
NORTH AMERICAN
DISTRIBUTOR

<https://www.loki-restraint.com/2>
THIS PRODUCT IS THE #1 DISTRIBUTED TACTICAL
SALES@AARDYARKTACTICAL.COM
EMAILTO:SALES@AARDYARKTACTICAL.COM

 <https://www.instagram.com/aardvarktactical/>
 https://www.facebook.com/Aardvark-Tactical-157034977662207/?ref=aymt_homepage_panel
 https://twitter.com/AARDYARK_TAC

Request a Quote

MATRICE 200 SERIES

BUILT TO ENDURE.
ENGINEERED TO ADAPT

PLAY VIDEO ▶

MATRICE 200 SERIES APPLICATIONS PAYLOADS SPECS VIDEOS DOWNLOADS FAQ CONTACT US

MATRICE 200 SERIES SPECS

Home

M200

AIRCRAFT

Model	M200
Package Dimensions	31.1x15.4x11.4inch (790x390x290mm)
Dimensions (unfolded)	34.9x34.6x14.9 inch (887x880x378 mm)
Dimensions (folded)	28.2x8.7x9.3 inch (716x220x236 mm)
Folding Method	Folded Inward
Diagonal Wheelbase	25.3 inch (643 mm)
Number of Batteries	2
Weight (TB50)	Approx. 3.80 kg
Weight (TB55)	Approx. 4.53 kg
Max Takeoff Weight	6.14KG
Max Payload (2 TB50)	Approx.2.34kg (with two standard batteries)
Max Payload (2 TB55)	Approx.1.61kg (with two standard batteries)
Hovering Accuracy (P-mode with GPS)	Vertical: ±1.64 feet (0.5m) or ±0.33 feet (0.1m, Downward Vision System enabled) Horizontal: ±4.92 feet (1.5m) or ±0.98 feet (0.3m, Downward Vision System enabled)
Max Angular Velocity	Pitch: 300°/s ; Yaw: 150°/s
Max Pitch Angle	P Mode: 30° (Forward Vision System enabled: 25°) ; A Mode: 35° ; S Mode: 35°
Max Ascent Speed	16.4 ft/s (5 m/s)
Max Descent Speed	Vertical: 9.8 ft/s (3 m/s)
Max Speed	

GIMBAL

Compatible Gimbals	Zenmuse X4S Zenmuse X5S Zenmuse Z30 Zenmuse XT
--------------------	---

REMOTE CONTROLLER

Model	GL60-10A
Operating Frequency	2,400-2,483 GHz 5,725-5,850 GHz
Max Transmitting Distance (unobstructed, free of interference)	2.4 GHz: 4.3 miles (7 km, FCC); 2.2 miles (3.5 km, CE); 2.5 miles (4 km, SRRC) 5.8 GHz: 4.3 miles (7 km, FCC); 1.2 miles (2 km, CE); 3.1 miles (5 km, SRRC)
EIRP	2.4 GHz: 26 dBm (FCC); 17 dBm (CE); 20 dBm (SRRC) 5.8 GHz: 28 dBm (FCC); 14 dBm (CE); 20 dBm (SRRC)
Video Output Ports	USB, HDMI
Power Supply	Built-in battery
Charging	DJI charger
Dual User Capability	Host-and-Slave connection
Mobile Device Holder	Tablet or Smart Phone
Max Mobile Device Width	170 mm
Output Power	9 W (Without supplying power to smart device)

	S Mode: 51.4mph (82.8kph) F Mode: 38mph (61.2kph) A Mode: 51.4mph (82.8kph)
Max Service Ceiling Above Sea Level	1.86 mi (3000 m)
Max Wind Resistance	39.4 ft/s (12 m/s)
Max Flight Time(No Payload, with TB50)	27min
Max Flight Time(No Payload, with TB55)	38min
Max Flight Time(Full Payload, with TB50)	13min
Max Flight Time(Full Payload, with TB55)	24min
Motor Model	DJI 3515
Propeller Model	17605
Operating Temperature	-4° to 113° F (-20° to 45° C)
IP Rating	IP43

Operating Temperature	-4° to 104° F (-20° to 45° C)
Storage Temperature	Less than 3 months: -4° to 113° F (-20° to 45° C) More than 3 months: 72° to 82° F (22° to 28° C)
Charging Temperature	32° to 104° F (0° to 40° C)
Battery	6000mAh 2S LiPo
USB Supply Power	iOS: 1 A @ 5.2 V (Max); Android: 1.5 A @ 5.2 V (Max)

GIMBAL INSTALLATION

Downward Gimbal Mount	Supported
Upward Gimbal Mount	Not Supported
Downward Dual Gimbal	Not Supported

BATTERY (OPTIONAL)

Model	TB55
Capacity	7660 mAh
Voltage	22.8V
Battery Type	LiPo 6S
Energy	176.93Wh
Net Weight	Approx. 885g
Operating Temperature	-4° to 113° F (-20° to 45° C)
Storage Temperature	Less than 3 months: -20° C to 45° C More than 3 months: 22° C to 28° C
Charging Temperature	41° to 104° F (5° to 40° C)
Max Charging Power	180 W

BATTERY (STANDARD)

Model	TB50
Capacity	4280mAh
Voltage	22.8V
Battery Type	LiPo 6S
Energy	97.58 Wh
Net Weight	Approx. 520g
Operating Temperature	-4° to 113° F (-20° to 45° C)
Storage Temperature	Less than 3 months: -4° to 113° F (-20° to 45° C) More than 3 months: 72° to 82° F (22° to 28° C)
Charging Temperature	41° to 104° F (5° to 40° C)
Max Charging Power	180 W

DJI GO 4 APP

Name	DJI GO 4
Mobile Device System Requirements	iOS 9.0 or later, Android 4.4.0 or later
Supported Mobile Devices	iOS: iPhone 5s, iPhone SE, iPhone 6, iPhone 6 Plus, iPhone 6s, iPhone 6s Plus, iPhone 7, iPhone 7 Plus, iPad Air, iPad Air Wi-Fi + Cellular, iPad mini 2, iPad mini 2 Wi-Fi + Cellular, iPad Air 2, iPad Air 2 Wi-Fi + Cellular, iPad mini 3, iPad mini 3 Wi-Fi + Cellular, iPad mini 4 and iPad mini 4 Wi-Fi + Cellular. This app is optimized for iPhone 7, iPhone 7 Plus, Android: Samsung tabs 705c, Samsung S6, Samsung S5, Samsung NOTE4, Samsung NOTE3, Google Nexus 6p, Nexus 9, Google Nexus 7 II, Ascend Mate7, Huawei P8 Max, Huawei Mate 8, LG V20, Nubia Z7 mini, Sony Xperia Z3, MI 3, Mi PAD, Smartisan T1.
	*Support for additional devices available as testing and development continues.

CHARGER

Model	JN2C180
Voltage	26.1 V
Rated Power	180 W

UPWARD INFRARED SENSOR

Obstacle Sensing Range	0-16.4 feet (0-5 m)
FOV	±5°
Operating Environment	Large-sized object with diffuse reflecting surface or high reflective rate (>10%)

FORWARD VISION SYSTEM

Obstacle Sensing Range	2.3-98.4 feet (0.7-30 m)
FOV	Horizontal 50° , Vertical 54°
Operating Environment	Surfaces with clear patterns and adequate lighting (> 15 lux)

DOWNWARD VISION SYSTEM

Velocity Range	<32.8 ft/s (10 m/s) at the height of 8.56 feet (2 m)
Altitude Range	<32.8 feet (10 m)
Operating Range	<32.8 feet (10 m)
Operating Environment	Surfaces with clear patterns and adequate lighting (> 15 lux)
Ultrasonic Sensor Operating Range	0.33-16.4 feet (10-500 cm)
Ultrasonic Sensor Operating Environment	Non-absorbing material, rigid surface (thick indoor carpeting will reduce performance)

M210

AIRCRAFT

Model	M210
Package Dimensions	31.1×15.4×11.4inch (790×390×290mm)
Dimensions (unfolded)	34.9×34.6×14.9 inch (887×880×378 mm)

GIMBALS

Compatible Gimbals	Zenmuse X4S Zenmuse X5S Zenmuse Z30 Zenmuse XT
--------------------	---

Dimensions (folded)	28.2x8.7x9.3 inch (716x220x236 mm)
Folding Method	Folded Inward
Diagonal Wheel Base	25.3 inch (643 mm)
Number of Batteries	2
Weight (TB50)	Approx. 3.84kg (with two standard batteries)
Weight (TB55)	Approx. 4.57kg (with two standard batteries)
Max Takeoff Weight	6.14KG
Max Payload (2 TB50)	Approx. 2.3kg (with two standard batteries)
Max Payload (2 TB55)	Approx. 1.57kg (with two standard batteries)
Hovering Accuracy (during safe flights)	Vertical: ±0.5 , Downward Vision System enabled: ±0.1 Horizontal: ±1.5 , Downward Vision System enabled: ±0.3
Max Angular Velocity	Pitch: 300°/s ; Yaw: 150°/s
Max Pitch Angle (Dual Downward Gimbals)	P Mode: 25° (Forward Vision System enabled: 25°) ; A Mode: 25° ; S Mode: 30°
Max Pitch Angle (Single Upward/Downward Gimbal)	P Mode: 30° (Forward Vision System enabled: 25°) ; A Mode: 30° ; S Mode: 35°
Max Ascend Speed	16.4 ft/s (5 m/s)
Max Descend Speed	Vertical: 9.8 ft/s (3 m/s)
Max Speed (Dual Downward Gimbals)	S Mode: 40.3mph (64.8kph) P Mode: 38mph (61.2kph) A Mode: 38mph (61.2kph)
Max Speed (Single Upward/Downward Gimbals)	S Mode: 51.4mph (82.8kph) P Mode: 38mph (61.2kph) A Mode: 51.4mph (82.8kph)
Max Service Ceiling Above Sea Level	1.85 miles (3000 m)
Max Wind Resistance	39.4 ft/s (12 m/s)
Max Flight Time (No Payload, with TB50)	27min
Max Flight Time (No Payload, with TB55)	38min
Max Flight Time (Full Payload, with TB50)	13min
Max Flight Time (Full Payload, with TB55)	24min
Motor Model	DJI 3515
Propeller Model	1760S
Operating Temperature	-4° to 113° F (-20° to 45° C)
IP Rating	IP43

GIMBAL INSTALLATION

Downward Gimbal Mount	Supported
Upward Gimbal Mount	Supported
Downward Dual Gimbal	Supported

CHARGER

Model	IN2C180
Voltage	26.1 V
Rated Power	180 W

FORWARD VISION SYSTEM

Obstacle Sensing Range	2.3-98.4 feet (0.7-30 m)
FOV	Horizontal 60° , Vertical 54°
Operating Environment	Surfaces with clear patterns and adequate lighting (> 15 lux)

DOWNWARD VISION SYSTEM

Velocity Range	<32.8 ft/s (10 m/s) at height of 6.56 feet (2 m)
Altitude Range	<32.8 feet (10 m)
Operating Range	<32.8 feet (10 m)
Operating Environment	Surfaces with clear patterns and adequate lighting (> 15 lux)
Ultrasonic Sensor Operating Range	0.33-16.4 feet (10-500 cm)
Ultrasonic Sensor Operating Environment	Non-absorbing material, rigid surface (thick indoor carpeting will reduce performance)

BATTERY

Model	TB50
Capacity	4280 mAh
Voltage	22.8V
Battery Type	LiPo 6S
Energy	97.58 Wh
Net Weight	Approx. 520g
Operating Temperature	-20° C to 45° C
Storage Temperature	Storage Temperature Less than 3 months: -4° to 113° F (-20° to 45° C) More than 3 months: 72° to 82° F (22° to 28° C)
Charging Temperature	41° to 104° F (5° to 40° C)
Max Charging Power	180 W
Model	TB55
Capacity	7660 mAh
Voltage	22.8V
Battery Type	LiPo 6S
Energy	176.93 Wh
Net Weight	Approx. 885 g
Operating Temperature	-4° to 113° F (-20° to 45° C)
Storage Temperature	Less than 3 months: -20° C to 45° C More than 3 months: 22° C to 28° C
Charging Temperature	41° to 104° F (5° to 40° C)
Max Charging Power	180 W

DJI GO 4 APP

Name	DJI GO 4
Mobile Device System Requirements	iOS 9.0 or later, Android 4.4.0 or later
Supported Mobile Devices	iOS: iPhone 5s, iPhone SE, iPhone 6, iPhone 6 Plus, iPhone 6s, iPhone 6s Plus, iPhone 7, iPhone 7 Plus, iPad Air, iPad Air Wi-Fi + Cellular, iPad mini 2, iPad mini 2 Wi-Fi + Cellular, iPad Air 2, iPad Air 2 Wi-Fi + Cellular, iPad mini 3, iPad mini 3 Wi-Fi + Cellular, iPad mini 4 and iPad mini 4 Wi-Fi + Cellular. This app is optimized for iPhone 7, iPhone 7 Plus. Android: Samsung tabs 705c, Samsung S6, Samsung S5, Samsung NOTE4, Samsung NOTE3, Google Nexus 6p, Nexus 9, Google Nexus 7 II, Ascend Mate7, Huawei PB Max, Huawei Mate 8, LG V20, Nubia Z7 mini, Sony Xperia Z3, MI3, MI PAD, Smartisan T1.
	*Support for additional devices available as testing and development continues.

UPWARD INFRARED SENSOR

Obstacle Sensing Range	0-16.4 feet (0-5 m)
FOV	±5°
Operating Environment	Large, diffuse and reflective obstacles (reflectivity>10%)

CENDENCE

Type	GL800A
Operating Frequency	2.400-2.483 GHz; 5.725-5.825 GHz
Max Transmitting Distance (unobstructed, free of interference)	2.4 GHz: 4.3 miles (7 km, FCC); 2.2 miles (3.5 km, CE); 2.5 miles (4 km, SRRC) 5.8 GHz: 4.3 miles (7 km, FCC); 1.2 miles (2 km, CE); 3.1 miles (5 km, SRRC)
EIRP	2.4 GHz: 26 dBm (FCC); 17 dBm (CE); 20 dBm (SRRC) 5.8 GHz: 26 dBm (FCC); 14 dBm (CE); 20 dBm (SRRC)
Power Supply	Extended Intelligent Battery (Model: WB37-4920mAh-7.6V)
Intelligent Battery	4923 mAh LiPo
Charging	DJI charger
Output Power	20 W (supplying power to DJI CS550 monitor) 12 W (without supplying power to monitor)
Video Output Ports	USB, HDMI, SDI
USB Supply Power	iOS: 1 A, 5.2 V (Max); Android: 1.5 A, 5.2 V (Max)
Dual User Capability	Master-and-Slave connection
Operating Temperature	-4° to 104° F (-20° to 40° C)
Storage Temperature	Less than 3 months: -4° to 113° F (-20° to 45° C) More than 3 months: 72° to 82° F (22° to 28° C)

Charging Temperature	32° to 104° F (0° to 40° C)
Charging Time	About 2 hours and 24 minutes (using a 180 W charger)
Supply Power Time	About 4 hours (only Master remote controller function enabled and without supplying power to monitor)
Weight	1041 g

M210 RTK

AIRCRAFT

Model	M210 RTK
Package Dimensions	31.1×15.4×11.4inch (790×390×290mm)
Dimensions (unfolded)	34.9×34.6×16.1 inch (Unfolded, 887×880×408 mm)
Dimensions (folded)	28.2×11.3×9.3 inch (Folded, 716×287×236 mm)
Folding Method	Folded inward
Diagonal Wheelbase	25.3 inch (643 mm)
Number of Batteries	2
Weight (TB50)	Approx. 4.42 kg
Weight (TB55)	Approx. 5.51 kg
Max Takeoff Weight	6.14 kg
Max Payload (2 TB50)	Approx. 1.72 kg (with two standard batteries)
Max Payload (2 TB55)	Approx. 0.99 kg (with two optional batteries)
Hovering Accuracy (P-mode with GPS)	Vertical: ±1.64 feet (0.5 m) or ±0.33 feet (0.1 m, Downward Vision System enabled) or ±0.33 feet (0.1 m, RTK enabled) Horizontal: ±4.92 feet (1.5 m) or ±0.98 feet (0.3 m, Downward Vision System enabled) or ±0.33 feet (0.1 m, RTK enabled)
Max Angular Velocity	Pitch: 300°/s, Yaw: 150°/s
Max Pitch Angle (Dual Downward Gimbals)	P Mode: 25° (Forward Vision System enabled: 25°) ; A Mode: 25° ; S Mode: 30°
Max Pitch Angle (Single Upward/Downward Gimbal)	P Mode: 30° (Forward Vision System enabled: 25°) ; A Mode: 30° ; S Mode: 35°
Max Ascent Speed	16.4 ft/s (5 m/s)
Max Descent Speed	Vertical: 9.8 ft/s (3 m/s)
Max Speed (Dual Downward Gimbals)	S Mode: 40.3mph (64.8kph) P Mode: 38mph (61.2kph) A Mode: 38mph (61.2kph)
Max Speed (Single Upward/Downward Gimbal)	S Mode: 51.4mph (82.8kph) P Mode: 38mph (61.2kph) A Mode: 51.4mph (82.8kph)
Max Service Ceiling Above Sea Level	1.86 miles (3000 m)
Max Wind Resistance	39.4 ft/s (12 m/s)
Max Flight Time (No Payload, with TB50)	23min
Max Flight Time (No Payload, with TB55)	32min
Max Flight Time (Full Payload, with TB50)	13min
Max Flight Time (Full Payload, with TB55)	24min
Motor Model	DJI 3515
Propeller Model	1760S
Operating Temperature	-4° to 113° F (-20° to 45° C)
IP Rating	IP43

GIMBAL INSTALLATION

Downward Gimbal Mount	Supported
Upward Gimbal Mount	Supported
Downward Dual Gimbal	Supported

CHARGER

Model	IN2C180
Voltage	26.1 V
Rated Power	180 W

FORWARD VISION SYSTEM

Obstacle Sensing Range	0.7 - 30 m ;
FOV	Horizontal 60° , Vertical 54°

GIMBALS

Compatible Gimbals	Zenmuse X4S Zenmuse X5S Zenmuse Z30 Zenmuse XT
--------------------	---

BATTERY

Model	TB50
Capacity	4280 mAh
Voltage	22.8V
Battery Type	LiPo 6S
Energy	97.58 Wh
Net Weight	Approx. 520g
Operating Temperature	-4° to 113° F (-20° to 45° C)
Storage Temperature	Less than 3 months: -4° to 113° F (-20° to 45° C) More than 3 months: 72° to 82° F (22° to 28° C)
Charging Temperature	41° to 104° F (5° to 40° C)
Max Charging Power	180 W
Model	TB55
Capacity	7660 mAh
Voltage	22.8V
Battery Type	LiPo 6S
Energy	176.93 Wh
Net Weight	885g
Operating Temperature	-20° C to 45° C
Storage Temperature	Less than 3 months: -20° C to 45° C More than 3 months: 22° C to 28° C
Charging Temperature	41° to 104° F (5° to 40° C)
Max Charging Power	180 W

DJI GO 4 APP

Name	DJI GO 4
Mobile Device System Requirements	iOS 9.0 or later, Android 4.4.0 or later
Supported Mobile Devices	iOS: iPhone 5s, iPhone SE, iPhone 6, iPhone 6 Plus, iPhone 6s, iPhone 6s Plus, iPhone 7, iPhone 7 Plus, iPad Air, iPad Air Wi-Fi + Cellular, iPad mini 2, iPad mini 2 Wi-Fi + Cellular, iPad Air 2, iPad Air 2 Wi-Fi + Cellular, iPad mini 3, iPad mini 3 Wi-Fi + Cellular, iPad mini 4 and iPad mini 4 Wi-Fi + Cellular. This app is optimized for iPhone 7, iPhone 7 Plus, Android: Samsung tabs 705c, Samsung S6, Samsung S5, Samsung NOTE4, Samsung NOTE3, Google Nexus 6p, Nexus 9, Google Nexus 7 II, Ascend Mate7, Huawei P8 Max, Huawei Mate 8, LG V20, Nubia Z7 mini, Sony Xperia Z3, MI 3, MI PAD, Smartisan T1.
	*Support for additional devices available as testing and development continues.

UPWARD INFRARED SENSOR

Obstacle Sensing Range	0-16.4 feet (0-5 m)
FOV	±5°
Operating Environment	Large-sized object with diffuse reflecting surface or high reflective rate (>10%)

CENDENCE

Type	GLB00A
Operating Frequency	2.400-2.483 GHz; 5.725-5.825 GHz

Operating Environment

Surfaces with clear patterns and adequate lighting (> 15 lux)

Max Transmitting Distance
(unobstructed, free of interference)

2.4 GHz: 4.3 miles (7 km, FCC); 2.2 miles (3.5 km, CE); 2.5 miles (4 km, SRRC)
5.8 GHz: 4.3 miles (7 km, FCC); 1.2 miles (2 km, CE); 3.1 miles (5 km, SRRC)

DOWNWARD VISION SYSTEM

Velocity Range

<32.8 fts (10 m/s) at height of 6.56 feet (2 m)

EIRP

2.4 GHz: 26 dBm (FCC); 17 dBm (CE); 20 dBm (SRRC)
5.8 GHz: 28 dBm (FCC); 14 dBm (CE); 20 dBm (SRRC)

Altitude Range

<32.8 feet (10m)

Power Supply

Extended Intelligent Battery (Model: WB37-4920mAh-7.6V)

Operating Range

<32.8 feet (10m)

Intelligent Battery

4923 mAh LiPo

Operating Environment

Surfaces with clear patterns and adequate lighting (> 15 lux)

Charging

DJI charger

Surfaces with clear patterns and adequate lighting (> 15 lux)

0.33-16.4 feet (10-500 cm)

Output Power

20 W (supplying power to DJI CS550 monitor)
12 W (without supplying power to monitor)

Ultrasonic Sensor Operating Environment

Non-absorbing material, rigid surface (thick indoor carpeting will reduce performance)

Video Output Ports

USB, HDMI, SDI

USB Supply Power

IOS: 1 A, 5.2 V (Max); Android: 1.5 A, 5.2 V (Max)

Data User Capability

Master-and-Slave connection

Operating Temperature

-4° to 104 °F (-20° to 40 °C)

Storage Temperature

Less than 3 months: -4° to 113 °F (-20° to 45 °C)
More than 3 months: 72° to 82 °F (22° to 28 °C)

Charging Temperature

32° to 104 °F (0° to 40 °C)

Charging Time

About 2 hours and 24 minutes (using a 180 W charger)

Supply Power Time

About 4 hours (only Master remote controller function enabled and without supplying power to monitor)

Weight

1041 g

MATRICE 200 SERIES VIDEOS

Home / Products / Matrice 200 Series

TUTORIALS



All Matrice 200 remote controllers are linked to the [DJI Goggles](#)

DJI Matrice 200 - Linking the Aircraft and the Remote Controller

2017-07-24

INTRO



DJI - M200 - Powerline Inspection Tool
2017-07-19

Light Support



MATRICE 200 SERIES
User Manual & Accessories List (v1.0)

DJI Matrice 200 Series - Updating the Remote Controller Firmware
2017-07-24



DJI Matrice 200 - Activating the Aircraft
2017-07-24

LOAD MORE



DJI - M200 - Search and Rescue in Extreme Environments
2017-07-19



DJI - Introducing the Matrice 200 Series (Extended Version)
2017-04-01

MATRICE 200 SERIES DOWNLOADS

Home / Products / Matrice 200 Series / Downloads

SOFTWARE

DJI Assistant 2 Release Notes
2017-12-29

ZIP

PDF



DJI Assistant 2 v.1.2.0
2017-12-29

ZIP

EXE



DJI Assistant 2 v.1.2.0
2017-12-29

ZIP

CAMERA FIRMWARE

Zenmuse Z30 Firmware
2017-08-29

ZIP

Zenmuse XT Firmware for Matrice 200 Series
2017-06-28

ZIP

DOCUMENTS & MANUALS

Matrice 200 series Release Notes
2017-12-29

ZIP

PDF

Matrice 210/Matrice 210 RTK User Manual v1.0
2017-09-19

ZIP

PDF

Matrice 210/Matrice 210 RTK Quick Start Guide v1.0
2017-08-01

ZIP

PDF

Matrice 210/Matrice 210 RTK in the Box
2017-08-01

ZIP

PDF

Matrice 200 User Manual v1.2
2017-09-19

ZIP

PDF

Matrice 200 Quick Start Guide v1.0
2017-06-21

ZIP

PDF

Matrice 200 In the Box
2017-06-21

ZIP

PDF

Matrice 200 series Safety Guidelines and Disclaimer v1.2
2017-09-26

ZIP

PDF

Matrice 200 series Intelligent Flight Battery Safety Guidelines v1.0
2017-06-21

ZIP

PDF

CrystalSky User Guide
2017-08-17

ZIP

PDF

M210/M210 RTK Dimensions

ZIP

PDF

2017-09-13

Matrice 200 series Maintenance Guide
2017-12-28

ZIP

PDF

APP / DJI PILOT



MATRICE 200 SERIES FAQ

Home / Products / Matrice 200 Series / FAQ

AIRCRAFT

- 1. What cameras and gimbals is the M200 series compatible with? >
- 2. Does the M200 series have an Obstacle Avoidance/FlightAutonomy system? >
- 3. What is the difference between the M100, M200 and M600? >
- 4. Is a case included with my M200 Series drone? >
- 5. What is IP43 protection rating, and in what scenarios can the Matrice 200 series be protected under this rating? >
- 6. Can I use the Matrice 200 series on rainy days? And what are some factors to consider when flying in rainy weather? >
- 7. Will I be covered if my aircraft incurs water damage? >
- 8. Does my M200 Series drone to be regularly checked when flying in sandy environments? >
- 9. Can I carry the M200 batteries on a commercial airplane? >
- 10. What happens if one battery fails? >
- 11. For the M210 RTK model, is there any extra setup required for this unit? >

APPLICATIONS

- 1. I'm a filmmaker, is this the best option for me? >
- 2. I'm a power line, telecom tower inspector and worry about interference affecting the safety of my inspection, which M200 Series model and payload will help me operate more safely? >
- 3. My business is interested in integrating drones into our business, where can we learn more? >

PAYLOADS

- 1. What cameras are compatible with the M200 series? >
- 2. What dual gimbal configurations are supported by the M210 models? >
- 3. How do I mount an upward payload? >
- 4. Can you fly with both the XT and Z30 at the same time? >
- 5. Can you mount a camera upwards and downwards at the same time? >
- 6. Can the Zenmuse XT camera be used with the M200 Series platform? >

SOFTWARE

- 1. What mobile software programs are compatible with the M200 series? >
- 2. What's new in the DJI Pilot app? >
- 3. What programs can I use for creating reproducible flight plans for automated flight? >
- 4. Where can I learn more about DJI FlightHub? >

OTHER

- 1. How long does it take to charge a remote controller? How long does it last on a full charge? >
- 2. Does my M200 Series drone come with a Micro SD card? >
- 3. What is the latency of the transmission system? >
- 4. Can you use batteries charged at different levels? >
- 5. Do I need to pair the batteries? >
- 6. Does the M200 Series support the Adobe CinemaDNG and Apple ProRes? >
- 7. Does the M200 have a RTH function? >
- 8. How do I enable autofocus? >

Product Categories

Consumer

Professional

Enterprise

Where to Buy

Online Store

Flagship Store

Retail Store

Support

Fly Safe

Product Support

Repair Services

Explore

Newsroom

Showcase

Events

Community

SkyPixel

DJI Forum

Developer

Subscribe

Get the latest news from DJI

Your email address >

ZENMUSE Z30

CLOSING THE DISTANCE



DJI - INTRODUCING ZENMUSE Z30



ZENMUSE Z30

[SPECS](#) [VIDEOS](#) [DOWNLOADS](#) [FAQ](#) [CONTACT US](#)

ZENMUSE Z30 SPECS

Home / Products / Zenmuse Z30 /

GENERAL

Name	Zenmuse Z30
Dimensions	152x137x61 mm
Weight	556g

CAMERA

Sensor	CMOS, 1/2.8" Effective Pixels: 2.13 M
Lens	30x Optical Zoom F1.6 (Wide) - F4.7 (Tele) Zoom Movement Speed: - Optical Wide - Optical Tele: 4.5 sec - Optical Wide - Digital Tele: 6.4 sec - Digital Wide - Digital Tele: 1.8 sec Focus Movement Time: - - near: 1.1 sec
FOV	63.7°(Wide) - 2.3°(Tele)
Digital Zoom	6x
Min. Working Distance	10 mm - 1200 mm
Photo Formats	JPEG
Video Formats	MOV, MP4
Working Modes	Capture, Record, Playback
Still Photography Modes	Single shot, Burst shooting: 3/5 frames, Interval (2/3/4/7/10/15/20/30 sec)
Exposure Mode	Exposure Mode Auto, Manual, Shutter priority, Aperture priority
Exposure Compensation	±2.3 (1/3 increments)

GIMBAL

Angular Vibration Range	±0.01°
Mount	Detachable
Controllable Range	Pitch: +40° to -90°, Yaw: ±320°
Mechanical Range	Pitch: +50° to -140°, Yaw: ±330°, Roll: +90° to -50°
Max Controllable Speed	Pitch: 180°/s, Yaw: 180°/s

ENVIRONMENTAL

Operating Temperature	14° to 113° F (-10° to 45° C)
Non-Operating Temperature	-4° to 140° F (-20° to 60° C)

Metering Mode	Center-weighted metering, Spot metering (Area option 12x8)
AE Lock	Supported
Electronic Shutter Speed	1/30 - 1/6000 s
White Balance	Auto, Sunny, Cloudy, Incandescent, Custom (2000K - 10000K)
Video Captions	Supported
TapZoom	Supported
TapZoom Range	1-5
Defog	Supported
One Key to 1X Image	Supported
Anti-Flicker	50 Hz, 60 Hz
PAL/NTSC	Supported
Supported SD Cards	MicroSD (SD / SDHC / SDXC) Max. Capacity: 64 GB, Class 10 or UHS-1
Supported File Systems	FAT32 (≤ 32 GB) exFAT (> 32 GB)

ZENMUSE Z30 VIDEOS

Products / Zenmuse Z30 / Videos

INTRO



Z30 Intro
2016-12-26

TUTORIALS



dji | ZENMUSE Z30

MOUNTING TO THE MATRICE 100

Zenmuse z30 Mounting To The Matrice 100
2016-12-28



Z30 Cell Tower Inspection
2016-12-26



Z30 Fire Firefighter
2016-12-26

LOAD MORE

ZENMUSE Z30 DOWNLOADS

Home / Zenmuse Z30 / Downloads

DOCUMENTS AND MANUALS

Zenmuse Z30 Release Notes
2017-08-29

ZIP

PDF

Zenmuse Z30 User Manual
2016-12-28

ZIP

PDF

Zenmuse Z30 Quick Start Guide
2016-12-28

ZIP

PDF

CAMERA FIRMWARE

Zenmuse Z30 Firmware
2017-08-29

ZIP

ZENMUSE Z30 FAQ

Home / Zenmuse Z30 / FAQ

- 1. What kind of zoom does the Zenmuse Z30 have? How much does it zoom by?
- 2. Can the Zenmuse Z30 be used on the Osmo handle?
- 3. What applications and what kind of specific scenarios are the Z30 suited for?
- 4. Is the Zenmuse Z30 compatible with the Inspire series?
- 5. What is the difference between the Zenmuse Z30 and Zenmuse Z30?
- 6. Will there be any video shake when using Zenmuse Z30?
- 7. What intelligent features does the Zenmuse Z30 support when used with the DJI Matrice 600?

ZENMUSE Z30

enterprise@dji.com

Contact us for more information

Product Categories

Consumer

Professional

Enterprise

Components

Where to Buy

Online Store

Flagship Store

Retail Store

Become a Dealer

Support

Fly Safe

Product Support

Repair Services

Help Purchasing

Explore

Newsroom

Showcase

Events

DJI Global Citizenship

Community

SkyPixel

DJI Forum

Developer

Subscribe

Get the latest news from DJI

Your email address



UNLOCK THE POSSIBILITIES OF SIGHT

Thermal imaging from the air has never been as easy as it is with the DJI Zenmuse XT. By combining DJI's unrivaled expertise in gimbal technology and image transmission with the industry leading thermal imaging technology of FLIR, the Zenmuse XT is the ultimate solution for rapid and reliable aerial thermal imaging. Capture faster, with pinpoint precision, over large areas, then save them for analysis and reporting.



Introducing the DJI Zenmuse XT

ZENMUSE XT

- [SPECS](#)
- [VIDEOS](#)
- [DOWNLOADS](#)
- [FAQ](#)
- [EXPORT](#)
- [CONTACT US](#)

ZENMUSE XT SPECS

Home / Products / Zenmuse XT /

GENERAL

Model	Zenmuse XT
Dimensions	103 mm x 74 mm x 102 mm
Weight	270 g

CAMERA

Thermal imager	Uncooled VOx Microbolometer
FPV/Digital Video Display Formats	<ul style="list-style-type: none"> • 640 × 512 • 336 × 256
Analog Video Display Formats	720 × 480 (NTSC); 720 × 576 (PAL)
Pixel Pitch	17 μm
Spectral Band	7.5 - 13.5 μm
Full Frame Rates	<ul style="list-style-type: none"> • 640 × 512 : 30 Hz (NTSC) 25 Hz (PAL) • 336 × 256 : 30 Hz (NTSC) 25 Hz (PAL)
Exportable Frame Rates	7.5 Hz NTSC; 8.3 Hz PAL
Sensitivity (NETD)	<50 mK at f/1.0
Scene Range (High Gain)	<ul style="list-style-type: none"> • 640 × 512 : -13° to 275°F (-25° to 135°C) • 336 × 256 : -13° to 212°F (-25° to 100°C)
Scene Range (Low Gain)	-40° to 1022° F (-40° to 550°C)
Spot Meter	Temperatures measured in central 4×4
File Storage	Micro SD Card
Photo Format	JPEG, TIFF
Video Format	MP4

GIMBAL

Angular Vibration Range	±0.03°
Mount	Detachable
Controllable Range	Tilt : +35° to -90°; Pan : ±320°; Roll : ±15°
Mechanical Range	Tilt : +45° to -135°; Pan : ±320°; Roll : ±45°
Max Controllable Speed	120°/s

IMAGE PROCESSING & DISPLAY CONTROLS

NTSC/PAL (field switchable)	yes
Image Optimization	yes
Digital Detail Enhancement	yes
Polarity Control (black hot/white hot)	yes
Color & Monochrome Palettes (LUTs)	yes
Digital Zoom	640 × 512 : 2x, 4x, 8x
	336 × 256 : 2x, 4x

ENVIRONMENTAL

Operating Temperature Range	14° to 104°F (-10° to 40°C)
Non-Operating Temperature Range	-22° to 158°F (-30° to 70°C)
Temperature Shock	5°C/min
Humidity	5% to 95%

LENS MODELS

Lens Models		6.8 mm	7.5 mm	9 mm	13 mm	19 mm
17μ640x512	FoV	/	f/1.4 90° x 69°	f/1.4 69° x 56°	f/1.25 45° x 37°	f/1.25 32° x 26°
	IFoV	/	2.267 mr	1.889 mr	1.308 mr	0.895 mr
17μ336x256	FoV	f/1.4 49.1° x 37.4°	/	f/1.25 35° x 27°	f/1.25 25° x 19°	f/1.25 17° x 13°
	IFoV	2.519 mr	/	1.889 mr	1.308 mr	0.895 mr
Min Focus Distance		2.3 cm	2.5 cm	3.2 cm	7.6 cm	15.3 cm
Hyperfocal Distance		1.2 m	1.2 m	2.1 m	4.4 m	9.5 m
Hyperfocal Depth of field		0.6 m	0.6 m	1.1 m	2.2 m	4.8 m

ZENMUSE XT VIDEOS

Home / Products / Zenmuse XT



Introducing the DJI Zenmuse XT

2015-12-10

ZENMUSE XT DOWNLOADS

4 items available for download

FIRMWARE





















- Zenmuse XT Firmware V1.24.0.10 (Inspire 1) [ZIP](#)
2016-12-22
- Zenmuse XT Firmware V1.24.0.10 (Matrice 100) [ZIP](#)
2016-12-22
- Zenmuse XT Firmware V1.24.0.10 (Matrice 600) [ZIP](#)
2016-12-22
- Zenmuse XT Firmware for Matrice 200 Series [ZIP](#)
2017-06-28

DOCUMENTS & MANUALS

- Zenmuse XT Release Notes [ZIP](#) [PDF](#)
2017-06-28
- Zenmuse XT User Manual [ZIP](#) [PDF](#)
2016-07-11
- Zenmuse XT Quick Start Guide [ZIP](#) [PDF](#)
2016-04-20
- Radiometry Technical Note [PDF](#)
2016-06-14
- Zenmuse XT Disclaimers and Warnings [ZIP](#) [PDF](#)
2016-03-22

ZENMUSE XT FAQ

Home Products / ZENMUSE XT

1. What is the different between Infrared Camera and general camera? 
2. Whether the aperture, focus length and shutter of ZENMUSE XT Camera can be adjusted? 
3. Whether ZENMUSE XT is able to take photos and record video simultaneously? 
4. How long is the flight time of Inspire 1 mounting with Zenmuse XT? 
5. What kind of equipment does ZENMUSE XT Camera support? 
6. Can the Zenmuse XT camera be used with the M200 Series platform? 
7. Can the lens of ZENMUSE XT Camera be replaced? 
8. Does the camera come with a standard SD card? 
9. What is DDE? 
10. What is SSO? 
11. Why the maximum resolution is only 640 x 512 ? 
12. Does the camera support 4K video recording? 
13. What is Zenmuse XT's video format? 
14. What is the option 'Palette'? 
15. What is the option 'Scene'? 
16. What is the option 'ROI'? 
17. What is the 'Isotherm' mode? 
18. What is TIFF format image? 
19. What kind of softwares can open TIFF format images? 
20. What is the accuracy and measurement range of TIFF format images? 
21. What factors will affect temperature? 

22. What is R-JPEG format image?

23. Can the Zenmuse XT camera be used with the M200 Series platform?

ZENMUSE XT EXPORT

Home / Products / Zenmuse XT / EXPORT

* Slow-rate thermal cameras (FLIR Tau 336 and 640 9 Hz models) sold by DJI are controlled under Department of Commerce, Bureau of Industry and Security Export Control Classification Number (ECCN) 6A993. These cameras may not be exported or re-exported to countries subject to U.S. economic sanctions, currently including Cuba, Iran, North Korea, Sudan, Syria, or the Crimea region of Ukraine. The cameras may not be transferred to prohibited parties or exported for a prohibited end use, as described in the U.S. Export Administration Regulations (EAR, 15 C.F.R. Parts 730 – 774).

* Full-rate thermal cameras (FLIR Tau 336 and 640 30 Hz models) sold by DJI are controlled for export under ECCN 6A003.b.4.b. These cameras may not be exported or re-exported to any country other than Canada without authorization from the U.S. government (in the form of a license or through use of a valid license exception). The cameras may not be transferred to prohibited parties or exported for a prohibited end use, as described in the EAR.

* For additional information regarding export restrictions applicable to these products, consult the EAR and the various sanctions regulations administered by the U.S. Department of Treasury's Office of Foreign Assets Control (31 C.F.R. Parts 501 – 598).

Product Categories	Where to Buy	Support	Explore	Community	Subscribe
Consumer	Online Store	Fly Safe	Newsroom	SkyPixel	Get the latest news from DJI
Professional	Flagship Store	Product Support	ShowCase	DJI Forum	<input type="text" value="Your email address"/> >
Enterprise	Retail Store	Repair Services	Events	Developer	
Components	Become a Dealer	Help Purchasing	DJI Global Citizenship		
	Authorized Retail Store	After-Sales Service Policies			

[Who We Are](#) | [Contact Us](#) | [Careers](#) | [RoboMaster](#)



MAVIC 2 ENTERPRISE ADVANCED

Dual Imaging, Reimagined



- 640 × 512 px Thermal Camera
- 48 MP Visual Camera
- 32× Digital Zoom
- Centimeter-level Positioning with RTK
- 10 km HD Transmission
- Omnidirectional Obstacle Sensing

[Buy Now](#)

Order Your Mavic 2 Enterprise Advanced Today

The Mavic 2 Enterprise Advanced is available for order through official DJI Dealers. Contact us below for the team to reach out.

Name *

Email *

Company *

Industry *

North America

United States

State *

Specs

Mavic 2 Enterprise Advanced

Aircraft

Takeoff Weight (Without Accessories)	909g
Max Takeoff Weight	1100g
Dimensions (L×W×H)	Folded: 214×91×84mm Unfolded: 322×242×84mm Unfolded+Spotlight: 322×242×114mm Unfolded+Beacon: 322×242×101mm Unfolded+Speaker: 322×242×140mm Unfolded+RTK Module: 322×242×125mm
Diagonal Distance	354 mm
Max Ascent Speed	6 m/s (S-mode) 5 m/s (P-mode) 4 m/s (S-mode with accessories) 4 m/s (P-mode with accessories)
Max Descent Speed	Descend Vertically 5 m/s (S-mode) 4 m/s (P-mode) Tilt 7 m/s (S-mode) 4 m/s (P-mode)
Max Speed	72 kph (S-mode, without wind) 50 kph (P-mode, without wind)
Max Service Ceiling Above Sea Level	6000 m
Max Flight Time	31 min (measured while flying at 25 kph in windless conditions) 28 min (RTK module attached) 29 min (with beacon turned on) 30 min (with beacon turned off) 24 min (with spotlight turned on) 28 min (with spotlight turned off) 27 min (with speaker turned on) 28 min (with speaker turned off)
Max Wind Speed Resistance	10 m/s (scale 5)
Max Tilt Angle	35° (S-mode, with remote controller) 25° (P-mode)
Max Angular Velocity	200°/s (S-mode) 100°/s (P-mode)
Operating Temperature	-10° to 40° C
GNSS	GPS+GLONASS
Hovering Accuracy Range	Vertical: ± 0.1 m (with RTK) ± 0.1 m (with Vision Positioning) ± 0.5 m (with GPS Positioning) Horizontal: ± 0.1 m (with RTK) ± 0.3 m (with Vision Positioning) ± 1.5 m (with GPS Positioning)

Operating Frequency	2,400-2.4835 GHz; 5,725-5,850 GHz
Transmitter Power (EIRP)	2,400 - 2.4835 GHz FCC: ≤26 dBm ; CE: ≤20 dBm ; SRRC: ≤20 dBm; MIC: ≤20 dBm 5,725 - 5.850 GHz FCC: ≤26 dBm; CE: ≤14 dBm; SRRC: ≤26 dBm
Internal Storage	24 GB

M2EA Thermal Camera

Sensor	Uncooled VOx Microbolometer
Focal Length	Approx. 9mm 35 mm format equivalent: Approx. 38mm
Sensor Resolution	640×512 @30Hz
Accuracy of Thermal Temperature	Measurement: ±2°C or ±2%, whichever is greater.
Scene Range	-40 °C to 150 °C (High Gain) -40 °C to 550 °C (Low Gain)
Digital Zoom	16 ×
Pixel Pitch	12 μm
Spectral Band	8-14 μm
Photo Format	R-JPEG
Video Format	MP4
Metering Method	Spot Meter, Area Measurement
FFC	Auto/Manual

M2EA Visual Camera

Sensor	1/2" CMOS, Effective Pixels: 48 M
Lens	FOV: 84° 35 mm format equivalent: 24 mm Aperture: f/2.8 Focus: 1 m to ∞
ISO Range	Video: 100-12800 (auto) Photos: 100-1600 (auto)
Digital Zoom	32×
Max Image Size	8000×6000
Still Photography Modes	Single shot Interval: 2/3/5/7/10/15/20/30/60 s Panorama: Sphere
Video Resolution	3840×2160@30fps 1920×1080@30fps
Photo Format	JPEG
Video Format	MP4

Gimbal

Mechanical Range	Tilt: -135°- +45° Pan: -100°- +100°
Controllable Range	Tilt: -90°- +30° Pan: -75°- +75°
Stabilization	3-axis (tilt, roll, pan)
Max control speed	120°/s
Angular Vibration Range	±0.005°

Sensing System

Sensing System	Omnidirectional Obstacle Sensing ^[2]
Forward	Precision Measurement Range: 0.5 - 20 m Detectable Range: 20 - 40 m Effective Sensing Speed: ≤ 14m/s FOV: Horizontal: 40°, Vertical: 70°
Backward	Precision Measurement Range: 0.5 - 16 m Detectable Range: 16 - 32 m Effective Sensing Speed: ≤ 12m/s FOV: Horizontal: 60°, Vertical: 77°
Upward	Precision Measurement Range: 0.1-8 m
Downward	Precision Measurement Range: 0.5 -11m Detectable Range: 11-22 m
Sides	Precision Measurement Range: 0.5 - 10 m Effective Sensing Speed: ≤ 8m/s FOV: Horizontal: 80°, Vertical: 65°
Operating Environment	Forward, Backward and Sides: Surface with clear pattern and adequate lighting (lux > 15) Upward: Detects diffuse reflective surfaces(>20%) (walls, trees, people, etc.) Downward: Surface with clear pattern and adequate lighting (lux > 15)Detects diffuse reflective surfaces (>20%) (walls, trees, people, etc.)

Remote Controller

Operating Frequency	2.400 - 2.483 GHz; 5.725 - 5.850 GHz
Max Transmission Distance (unobstructed, free of interference)	2.400 - 2.483 GHz; 5.725 - 5.850 GHz FCC: 10000m CE: 6000m SRRC: 6000m MIC: 6000m
Transmission Power (EIRP)	2.400-2.4835 GHz : 25.5 dBm (FCC) ; 18.5 dBm (CE) 19 dBm (SRRC) ; 18.5 dBm (MIC) 5.725-5.850 GHz : 25.5 dBm (FCC) ; 12.5 dBm (CE) 18.5 dBm (SRRC)
Storage	ROM 16GB + microSD Extensible Storage
Video Output Port	HDMI Port
Built-in Battery	Type: 18650 Li-Po (5000 mAh @ 7.2 V) Charging Mode: Charged with USB charger at 12V/2A Rated Power 15 W Charging time: 2 hr (with a USB charger at 12V/2A)
Operating Current/Voltage	1800mA – 3.83V
Battery Life	Built-in Battery Approx. 2.5 hr

Operating Temperature	-20° C -40° C
RC Size	Folded without Joystick: 177.5 x 121.3 x 40 mm Unfolded with Joystick: 177.5 x 181 x 60 mm
Weight	Approx. 630 g
Intelligent Flight Battery	Main Link: 17.6V – 3.41A or 17.0V–3.53A USB: 5.0 V – 2.0 A

Intelligent Flight Battery

Capacity	3850 mAh
Voltage	15.4V
Max Charging Voltage	17.6V
Battery Type	LiPo
Energy	59.29 Wh
Net Weight	297g
Charging Temperature	5°C - 40°C
Operating Temperature Range:	-10°C - 40°C
Heating Methods:	Manual Heating, Auto Heating
Heating Temperature	-20°C - 6°C
Heating duration	500s (Max)
Heating Power	55W (Max)
Charging Time	90 mins
Max Charging Power	80W

RTK Module

Dimensions	69 mm x 69 mm x 59mm
Connections	Micro USB Port
RTK Positioning Precision	In RTK FIX 1cm+1ppm (Horizontal) 1.5cm+1 ppm (Vertical)

M2EA Spotlight

Dimensions	68×60×41 mm
Connections	Micro USB Port
Operating Range	30 m
Power	Max 26W
Illuminance	FOV17°, Max: 11 lux @ 30m Straight

M2EA Beacon

Dimensions	68mm×40mm×27.8mm
Connections	Micro USB Port
Power	Avg. 1.6W

Controllable Range	5000 m
Light Intensity	Min Angle: 55 cd; Light Intensity: 157cd

M2EA Speaker

Dimensions	68×55×65 mm
Connections	Micro USB Port
Power	Max 10W
Decibel	100 db @ 1 meter distance
Max Bitrate	16kbps

SD Cards

Supported SD Cards	Micro SD™ Supports a microSD with capacity of up to 128 GB. A UHS-I Speed Grade 3 rating microSD card is required.
---------------------------	--

APP / Live View

Video Transmission System	OcuSync 2.0
Mobile App	DJI PILOT(Android Version)
Live View Quality	Remote Controller: 720p@30fps / 1080p@30fps
Max Live View Bitrate	40Mbps
Latency	120 - 130 ms
Required Operating System	ios 10.0 or later Android 5.0 or later

Others

Footnotes

[1] The accuracy of the temperature measurement is measured at a distance of 5m against a blackbody with an emissivity of 0.95 under Ideal conditions. The actual accuracy is also affected by various environmental factors such as temperature and humidity, and needs to be corrected by post-processing software. Under ideal conditions, the temperature accuracy can reach $\pm 2^{\circ}\text{C}$ or $\pm 2\%$, whichever is greater.

[2] Omnidirectional Obstacle Sensing includes left/right, up/down, and forward/backward obstacle sensing. Sensing for left/right directions is only available in Tripod Mode. Omnidirectional Obstacle Sensing does not fully cover the circumference of a 360-degree arc. And left and right obstacle sensing system only works in specific modes and environments. DJI warranty does not cover any loss caused by crashing when flying left or right, even when Tripod mode is activated. Please be aware of your surroundings and App notifications when operating the Mavic 2 to ensure safety.

Product Categories

Consumer
Professional
Enterprise
Components

Support & Care

DJI Care Refresh
DJI Care Refresh +
DJI Care Pro
OsmoShield

Where to Buy

DJI Online Store
Flagship Stores
DJI-Operated Stores
Retail Stores
Enterprise Retailers
Agricultural Drone Dealer
Pro Retailers
DJI Store App

Help Center

Fly Safe

Fly Safe
DJI Flying Tips
Support
Product Support
Repair Services
Help Center
After-Sales Service Policies
Download Center
Security and Privacy

Explore

Newsroom
Events
Buying Guides
STEAM Education
Mini Drones
DJI Camera Drones

Community

SkyPixel
DJI Forum
Developer
Subscribe
Get the latest news from DJI

Your email address

PHANTOM 4 PRO

VISIONARY INTELLIGENCE.
ELEVATED IMAGINATION.



DJI – Introducing Phantom 4 Pro

PHANTOM 4 PRO

[SPECS](#) [VIDEOS](#) [DOWNLOADS](#) [FAQ](#) [BUY NOW](#)

PHANTOM 4 PRO SPECS

Home / PHANTOM 4 PRO / SPECS

AIRCRAFT

Weight (Battery & Propellers Included)	1388 g
Diagonal Size (Propellers Excluded)	350 mm
Max Ascent Speed	S-mode: 6 m/s P-mode: 5 m/s
Max Descent Speed	S-mode: 4 m/s P-mode: 3 m/s
Max Speed	S-mode: 45 mph (72 kph) A-mode: 36 mph (58 kph) P-mode: 31 mph (50 kph)
Max Tilt Angle	S-mode: 42° A-mode: 35° P-mode: 25°
Max Angular Speed	S-mode: 250°/s A-mode: 150°/s
Max Service Ceiling Above Sea Level	19685 feet (6000 m)
Max Wind Speed Resistance	10 m/s
Max Flight Time	Approx. 30 minutes
Operating Temperature Range	32° to 104°F (0° to 40°C)
Satellite Positioning Systems	GPS/GLONASS
Hover Accuracy Range	Vertical: ±0.1 m (with Vision Positioning) ±0.5 m (with GPS Positioning) Horizontal: ±0.3 m (with Vision Positioning) ±1.5 m (with GPS Positioning)

GIMBAL

Stabilization	3-axis (pitch, roll, yaw)
Controllable Range	Pitch: -90° to +30°
Max Controllable Angular Speed	Pitch: 90°/s
Angular Control Accuracy	±0.02°

INFRARED SENSING SYSTEM

Obstacle Sensory Range	0.6 - 23 feet (0.2 - 7 m)
FOV	70° (Horizontal), ±10° (Vertical)
Measuring Frequency	10 Hz
Operating Environment	Surface with diffuse reflection material, and reflectivity > 8% (such as wall, trees, humans, etc.)

REMOTE CONTROLLER

Operating Frequency	2,400 - 2,483 GHz and 5,725 - 5,825 GHz
Max Transmission Distance	2,400 - 2,483 GHz (Unobstructed, free of interference) FCC: 4.3 mi (7 km) CE: 2.2 mi (3.5 km) SRRC: 2.5 mi (4 km) 5,725 - 5,825 GHz (Unobstructed, free of interference) FCC: 4.3 mi (7 km) CE: 1.2 mi (2 km) SRRC: 3.1 mi (5 km)

VISION SYSTEM

Vision System	Forward Vision System Backward Vision System Downward Vision System
Velocity Range	≤31 mph (50 kph) at 6.6 ft (2 m) above ground
Altitude Range	0 - 33 feet (0 - 10 m)
Operating Range	0 - 33 feet (0 - 10 m)
Obstacle Sensory Range	2 - 98 feet (0.7 - 30 m)
FOV	Forward: 60°(Horizontal), ±27°(Vertical) Backward: 60°(Horizontal), ±27°(Vertical) Downward: 70°(Front and Rear), 50°(Left and Right)
Measuring Frequency	Forward: 10 Hz Backward: 10 Hz Downward: 20 Hz
Operating Environment	Surface with clear pattern and adequate lighting (lux>15)

Operating Temperature Range	32° to 104°F (0° to 40°C)
Battery	6000 mAh LiPo 2S
Transmitter Power (EIRP)	2.400 - 2.483 GHz FCC: 26 dBm CE: 17 dBm SRRC: 20 dBm MIC: 17 dBm 5.725 - 5.825 GHz FCC: 28 dBm CE: 14 dBm SRRC: 20 dBm MIC: -
Operating Current/Voltage	1.2 A@7.4 V
Video Output Port	GL300E: HDMI GL300F: USB
Mobile Device Holder	GL300E: Built-in display device (5.5 inch screen, 1920×1080, 1000 cd/m², Android system, 4 GB RAM + 16 GB ROM) GL300F: Tablets and smart phones

CAMERA

Sensor	1" CMOS Effective pixels: 20M
Lens	FOV 84° 8.8 mm/24 mm (35 mm format equivalent) f/2.8 - f/11 auto focus at 1 m - ∞
ISO Range	Video: 100 - 3200 (Auto) 100 - 6400 (Manual) Photo: 100 - 3200 (Auto) 100 - 12800 (Manual)
Mechanical Shutter Speed	8 - 1/2000 s
Electronic Shutter Speed	8 - 1/8000 s
Image Size	3:2 Aspect Ratio: 5472 × 3648 4:3 Aspect Ratio: 4864 × 3648 16:9 Aspect Ratio: 5472 × 3078
PV Image Size	4096×2160(4096×2160 24/25/30/48/50p) 3840×2160(3840×2160 24/25/30/48/50/60p) 2720×1530(2720×1530 24/25/30/48/50/60p) 1920×1080(1920×1080 24/25/30/48/50/60/120p) 1280×720(1280×720 24/25/30/48/50/60/120p)
Still Photography Modes	Single Shot Burst Shooting: 3/5/7/10/14 frames Auto Exposure Bracketing (AEB): 3/5 bracketed frames at 0.7 EV Bias Interval: 2/3/5/7/10/15/20/30/60 s
Video Recording Modes	H.265 C4K: 4096×2160 24/25/30p @100Mbps 4K: 3840×2160 24/25/30p @100Mbps 2.7K: 2720×1530 24/25/30p @65Mbps 2.7K: 2720×1530 48/50/60p @80Mbps FHD: 1920×1080 24/25/30p @60Mbps FHD: 1920×1080 48/50/60p @65Mbps FHD: 1920×1080 120p @100Mbps HD: 1280×720 24/25/30p @25Mbps HD: 1280×720 48/50/60p @35Mbps HD: 1280×720 120p @60Mbps H.264 C4K: 4096×2160 24/25/30/48/50/60p @100Mbps 4K: 3840×2160 24/25/30/48/50/60p @100Mbps 2.7K: 2720×1530 24/25/30p @80Mbps 2.7K: 2720×1530 48/50/60p @100Mbps FHD: 1920×1080 24/25/30p @60Mbps FHD: 1920×1080 48/50/60p @60Mbps FHD: 1920×1080 120p @100Mbps HD: 1280×720 24/25/30p @30Mbps HD: 1280×720 48/50/60p @45Mbps HD: 1280×720 120p @80Mbps
Max Video Bitrate	100 Mbps
Supported File Systems	FAT32 (≤32 GB); exFAT (>32 GB)
Photo	JPEG, DNG (RAW), JPEG + DNG
Video	MP4/MOV (AVC/H.264; HEVC/H.265)
Supported SD Cards	Micro SD Max Capacity: 128GB Write speed ≥15MB/s, Class 10 or UHS-1 rating required
Operating Temperature Range	32° to 104°F (0° to 40°C)

INTELLIGENT FLIGHT BATTERY

Capacity	5870 mAh
Voltage	15.2 V
Battery Type	LiPo 4S
Energy	89.2 Wh
Net Weight	468 g
Charging Temperature Range	41° to 104°F (5° to 40°C)
Max Charging Power	160 W

CHARGER

Voltage	17.4 V
Rated Power	100 W

APP / LIVE VIEW

Mobile App	DJI GO 4
Live View Working Frequency	2.4GHz ISM, 5.8GHz ISM
Live View Quality	720P @ 30fps
Latency	Phantom 4 Pro: 220 ms (depending on conditions and mobile device) Phantom 4 Pro* : 160 - 180 ms
Required Operating Systems	iOS 9.0 or later Android 4.4.0 or later

PHANTOM 4 PRO VIDEOS

Home / Products / Phantom 4 Pro

TUTORIALS

SHOWCASE



DJI - Phantom 4 Pro - How to Fly - Safe Flight Advice
2017-03-08



DJI - Introducing Phantom 4 Pro
2016-11-15



DJI - Phantom 4 Pro - Narrow Sensing
2017-01-08



DJI - Phantom 4 Pro - ActiveTrack
2017-03-08



DJI - Phantom 4 Pro - Hawaiian Lava
2016-11-15





















DJI - Phantom 4 Pro - Sharper Vision
2016-11-15

LOAD MORE

PHANTOM 4 PRO DOWNLOADS

Home / Products / Phantom 4 Pro

DOCUMENTS & MANUALS

- Phantom 4 Pro/Pro+ Release Notes
2017-12-25  
- Phantom 4 Pro/Pro+ User Manual v1.4
2017-10-17  
- Phantom 4 Pro Quick Start Guide v1.0
2017-01-25  
- Phantom 4 Pro+ Quick Start Guide v1.0
2017-01-25  
- Phantom 4 Pro/Pro+ Disclaimer and Safety
Guidelines v1.2
2017-10-02  
- Phantom 4 Pro In the Box
2017-01-25  
- Phantom 4 Pro+ In the Box
2017-01-25  
- Phantom 4 Series Intelligent Flight Battery Safety
Guidelines v1.0
2017-01-25  
- D-Log Grading Guide
2017-06-08  

FIRMWARE

- Phantom 4 Pro+ Remote Controller Firmware
v01.02.02.00
2017-09-30 
- How to Update Phantom 4 Pro+ Remote
Controller Firmware
2017-03-07  

APP / LIVE VIEW

iOS Version v4.1.20.
Requires iOS 9.0 or later. Compatible with iPhone 5s, iPhone SE, iPhone 6, iPhone 6 Plus, iPhone 6s, iPhone 6s Plus, iPhone 7, iPhone 7 Plus, iPad Air, iPad Air Wi-Fi + Cellular, iPad mini 2, iPad mini 2 Wi-Fi + Cellular, iPad Air 2, iPad Air 2 Wi-Fi + Cellular, iPad mini 3, iPad mini 3 Wi-Fi + Cellular, iPad mini 4 and iPad mini 4 Wi-Fi + Cellular, iPod touch (6th generation). This app is optimized for iPhone 7, iPhone 7 Plus.

Android Version v4.1.22
Android version 4.4.0 or later. Compatible with Samsung S8, Samsung S7 edge, Samsung S7, Samsung S6, Samsung S5, Samsung NOTE4, Samsung NOTE3, Samsung tabs 705c, Ascend Mate 9, Ascend Mate 7, Huawei Honor 8, Huawei P8 Max, Vivo X7, Xiaomi 5, Google Nexus 6p, Nexus 9, Google Nexus 7 II, LG V20.





*Support for additional devices available as testing and development continues.



STRAIGHT-FROM-THE-PHANTOM-4-PRO

Straight-from-the-Phantom-4-Pro
2016-11-16 

SOFTWARE

- DJI Assistant 2 Release Notes
2017-12-29  
- DJI Assistant 2 v1.2.0
2017-12-29  
- DJI Assistant 2 v1.2.0
2017-12-29 

PHANTOM 4 PRO FAQ

Products / Phantom 4 Pro / FAQ

PRODUCT

- 1. What are the main differences between the Phantom 4 and Phantom 4 Pro? >
- 2. What, if any, are the main differences between the Phantom 4 Pro and Phantom 4 Pro Obsidian? >
- 3. Which Micro SD cards are supported? >

4. Does the Phantom 4 Pro Obsidian come with similar looking matte grey accessories?

CAMERA

1. What is new about the Phantom 4 Pro's camera?

2. What advantages does the Phantom 4 Pro have for shooting video?

3. What is the resolution and format of the photos captured while recording video?

4. What is the advantage using the new 4K 265 video format?

5. What's the benefit of having a mechanical shutter?

6. Does the Phantom 4 Pro support focus?

7. What are the main features of the Phantom 4 Pro camera lens?

OBSTACLE SENSING SYSTEM

1. When do the infrared sensing system work during flight?

2. How do the infrared sensing system work?

3. What improvements have been made to the Phantom 4 Pro's obstacle sensing system?

4. Is there any difference between the front and rear obstacle sensing systems?

REMOTE CONTROLLER

1. Are the Phantom 4 and Phantom 4 Pro remote controllers compatible with each other?

2. What's new in the Phantom 4 Pro remote controller?

3. Can I detach the integrated display from the Phantom 4 Pro remote controller?

4. Can I connect an iOS device or Android device to the Phantom 4 Pro remote controller to use DJI GO 4?

5. Does the Phantom 4 Pro remote controller have a built-in loudspeaker and microphone?

6. What is the resolution of the Phantom 4 Pro remote controller display?

7. What apps are preloaded on the Phantom 4 Pro remote controller display?

8. What operating system does the Phantom 4 Pro remote controller display use?

9. Is the remote controller's screen display's brightness adjusted automatically or manually?

10. Can I download other apps onto the Phantom 4 Pro remote controller display?

11. Does the Phantom 4 Pro remote controller support Wi-Fi and Bluetooth connectivity?

INTELLIGENT FUNCTIONS

- 1.What new Intelligent Flight Modes are on the Phantom 4 Pro? >
- 2.How is Phantom 4 Pro's Smart Return Home improved? >
- 3.How to use Narrow Sensing? >

PROPULSION SYSTEM

- 1.Can use Phantom 4 propellers on the Phantom 4 Pro? >
- 2.How is Phantom 4 Pro's propulsion system optimized? >

VIDEO TRANSMISSION SYSTEM

- 1.What is difference between Phantom 4 and Phantom 4 Pro Lightbridge systems? >

BATTERIES AND BATTERY CHARGER

- 1.Are the Phantom 4 Pro batteries and battery charger compatible with the Phantom 4? >
- 2.What is the capacity of the Phantom 4 Pro battery? How much has the flight time been extended compared to the Phantom 4? >

FIRMWARE UPGRADE

- 1.During upgrading, if the level of flight battery or controller battery drops below 50%, will the upgrading process fail? >
- 2.What if battery firmware is not consistent with the upgraded aircraft? >

BUY PHANTOM 4 PRO
VISIONARY INTELLIGENCE.ELEVATED IMAGINATION.

Product Categories	Where to Buy	Support	Explore	Community	Subscribe
Consumer	Online Store	Fly Safe	Newsroom	SkyPixel	Get the latest news from DJI
Professional	Flagship Store	Product Support	Showcase	DJI Forum	<input type="text" value="Your email address"/> >
Enterprise	Retail Store	Repair Services	Events	Developer	
Components	Become a Dealer	Help Purchasing	DJI Global Citizenship		
	Authorized Retail Store	After-Sales Service Policies			

OC VAPOR AEROSOL GRENADE



*OC DELIVERY IN CONFINED AREAS
WITH SHORT TERM EFFECTS*

OC VAPOR AEROSOL GRENADE

The Defense Technology® OC Vapor Aerosol Grenade delivers a very high concentration of Oleoresin Capsicum (OC) in a powerful mist. This inflames the mucous membranes and exposed skin, resulting in an intense burning sensation. Inhalation of the OC Vapor produces an immediate respiratory effect, which resolves within minutes when the subject is removed from the affected area to fresh air. Minimal decontamination of personnel or material is required after deployment. The OC Vapor Aerosol Grenade is ideal for cell extractions or barricade situations where the use of pyrotechnic, powder or liquid devices is not practical or desired.

FEATURES

- Delivers a very high concentration of OC in a powerful mist
- Immediate incapacitating effects
- Minimal decontamination
- Non-flammable
- For indoor use

⚠ WARNING: This product can expose you to chemicals including Lead Salts and Hexavalent Chromium, which are known to the State of California to cause cancer, and Lead Salts, which are known to the State of California to cause birth defects or other reproductive harm. For more information go to <http://www.P65Warnings.ca.gov>



Pistols

Submachine Guns

Assault Rifles

Machine Guns

Precision Rifles

40 mm Systems



Overview

Technical Data

Accessories

MP5 | Technical Data

MP5A3 – CAL. 9 MM X 19

General

Calibre

9 mm x 19

Operating principle

Delayed roller locked bolt

Magazine capacity

15/30 rounds

Modes of fire

0-1-D

Rate of fire

approx. 800/min

Sights

D

Buttstock

R

Dimensions

Length min./max.

approx. 550/690 mm

Width

approx. 67.0 mm

Height

approx. 230.0 mm

Barrel length

approx. 225 mm

Sight radius

approx. 340.0 mm

Weight

Weapon

approx. 3,100 g

Magazine

approx. 120/170 g

MP5A4 – CAL. 9 MM X 19

General

Calibre

9 mm x 19

MP5

MP5



MP5SD



MP5K



Submachine Guns

MP7A1



UMP



MP5



Modes of fire	0-1-3-D
Rate of fire	approx. 800/min
Sights  	D
Buttstock 	FX
Dimensions	
Length min./max.	approx. 675 mm
Width	approx. 67.0 mm
Height 	approx. 230.0 mm
Barrel length	approx. 225 mm
Sight radius	approx. 340.0 mm
Weight	
Weapon 	approx. 2,895 g
Magazine 	approx. 120/170 g

MP5A5 – CAL. 9 MM X 19

General

Calibre	9 mm x 19
Operating principle	Delayed roller locked bolt
Magazine capacity	15/30 rounds
Modes of fire	0-1-3-D
Rate of fire	approx. 800/min
Sights  	D
Buttstock 	R

Dimensions

Length min./max.	approx. 550/690 mm
Width	approx. 67.0 mm
Height 	approx. 230.0 mm
Barrel length	approx. 225 mm
Sight radius	approx. 340.0 mm
Weight	
Weapon 	approx. 3,100 g
Magazine 	approx. 120/170 g

Subject to modification



Print page
Create print view.

[to top](#) 

HECKLER & KOCH Group

 HECKLER & KOCH GmbH

Heckler & Koch-Str. 1 | 78727 Oberndorf a.N.
Germany
Tel +49 (0)7423 79-0 | Fax +49 (0)7423 79-2350
hkinfoboard@heckler-koch-de.com

 Heckler & Koch Defense Inc.

 NSAF Ltd.

 HECKLER & KOCH France SAS

Quicklinks

- [Documents Annual General Meeting](#)
- [Heckler & Koch Defense USA](#)
- [Heckler & Koch Onlineshop](#)

2021-DOJ_OIS Protocol.pdf

<p>California Department of Justice DIVISION OF LAW ENFORCEMENT John D. Marsh, Acting Chief</p> 	<h1>INFORMATION BULLETIN</h1>	
<p><i>Subject:</i></p> <p>Assembly Bill (AB) 1506 Definitions and Law Enforcement Agency's Notification Responsibility</p>	<p><i>No.</i></p> <p>2021-DLE-03</p>	<p><i>Contact for information:</i></p> <p>John D. Marsh, Acting Chief Division of Law Enforcement (916) 210-6300</p>
	<p><i>Date:</i></p> <p>6/24/2021</p>	

TO: ALL DISTRICT ATTORNEYS, CHIEFS OF POLICE, SHERIFFS, AND STATE LAW ENFORCEMENT AGENCIES

Effective July 1, 2021, pursuant to AB 1506, the Department of Justice (DOJ) is required to investigate “incidents of an officer-involved shooting resulting in the death of an unarmed civilian.” (Gov. Code, § 12525.3, subd. (b)(1).) The following is DOJ’s understanding of the terms used in this statute, and is to be used as guidance for all law enforcement partners in determining whether a case falls within the ambit of AB 1506. These definitions are meant to apply *only* in the context of AB 1506, and these terms may have different meanings in other contexts or in different statutes.

Notwithstanding these definitions, DOJ may elect to assume jurisdiction in cases where jurisdiction is unclear, or based on other extenuating circumstances, as determined by the Attorney General. (See Cal. Const., art V, § 13 [Attorney General is “chief law officer of the State” and has a duty “to see that the laws of the State are uniformly and adequately enforced”].)

1. “Officer-involved”

A shooting is “officer-involved” if the death to the unarmed civilian is caused by a California peace officer, within the meaning of Penal Code section 830, acting under color of authority. All shootings committed by officers while on duty are officer-involved shootings. Shootings committed by officers while off-duty are considered officer-involved shootings only if the officer is acting under color of authority.

Officers are acting under “color of authority” when they are performing an act that is made possible only because they are clothed with the authority of law, or when they are acting under pretense of law. Conversely, officers are not acting under “color of authority” when they commit private acts in furtherance of personal pursuits. Shootings by correctional officers as defined in Penal Code section 830.55 are excluded.

2. “Shooting”

A “shooting” is the discharge of a metal projectile by a firearm. A “firearm” is a “device, designed to be used as a weapon, from which is expelled through a barrel, a projectile by the force of an explosion or other form of combustion.” (Pen. Code, § 16520.) A “shooting” does not include incidents involving

the use of electronic control devices, stun guns, BB, pellet, air, gas-powered guns, or weapons that discharge rubber bullets or beanbags.

3. “Unarmed civilian”

An “unarmed civilian” is “anyone who is not in possession of a deadly weapon.” (Gov. Code, § 12525.3, subd. (a)(2).)

4. “Possession”

A civilian is in “possession” if the weapon is under the civilian’s dominion and control at the time of the shooting. Possession usually requires that the weapon is available for use. Where a civilian attempts to take control of an officer’s firearm, the civilian is not in possession unless the officer loses control of the firearm.

5. “Deadly weapon”

“‘Deadly weapon’ includes, but is not limited to, any loaded weapon from which a shot, readily capable of producing death or other serious physical injury, may be discharged, or a switchblade knife, pilum, ballistic knife, metal knuckle knife, dagger, billy, blackjack, plastic knuckles, or metal knuckles.” (Gov. Code, § 12525.3, subd. (a)(1).) All firearms, and BB/pellet guns, even if unloaded or inoperable, are deadly weapons.

Objects that have a legitimate non-weapon purposes are considered deadly weapons only when, based on all the circumstances, they are actually being used in a manner likely to produce death or great bodily injury. The following are examples of objects that have been considered a deadly weapon when used in that manner: knives, box cutters, screwdrivers, bottles, chains, automobiles, rocks, razor blades, and iron bars.

Replica firearms are not considered deadly weapons unless they are used in some particular manner likely to produce death or great bodily injury (e.g., as a bludgeon).

6. “Death”

Death occurs when “[a]n individual ... has sustained either (1) irreversible cessation of circulatory and respiratory functions, or (2) irreversible cessation of all functions of the entire brain, including the brain stem[.]” (Health & Saf. Code, § 7180.) DOJ may assume responsibility for cases where death appears to be imminent.

Law Enforcement Agency’s (LEA) Notification Responsibility

Effective July 1, 2021, immediately notify the DOJ when the LEA has an incident of an officer-involved shooting resulting in the death of an unarmed civilian. When situations arise and it is undetermined if the civilian was unarmed, a notification to DOJ is still requested. The Los Angeles Regional Criminal Information Clearinghouse (LA CLEAR) will be the central point of contact for all officer-involved shooting incident notifications: **(800) 522-5327**.

Statutes and Legal Requirements.pdf

Statutes and Legal Requirements

Items listed in this section include sections from the California Penal Code (CPC), Welfare and Institutions Code (WI) and Government Code (GC).

Definitions

CPC 422.55 - Provides general definition of hate crimes in California.

CPC 422.56- Provides definitions of terms included in hate crimes statutes.

GC 12926- Disability-related definitions applicable to some hate crime statutes.

Felonies

Hate Crimes

CPC 422.7 - Commission of a crime for the purpose of interfering with another's exercise of civil rights.

Related Crimes

CPC 190.2(a)(16) - Homicide penalties related to certain hate crime related acts.

CPC 190.03(a) - Homicide penalties related to certain hate crime related acts.

CPC 288(b)(2) - Sexual assault of dependent person by caretaker

CPC 368(b) - Dependent adult abuse generally - may apply as disability-related hate crime.

CPC 594.3 - Vandalism of places of worship.

CPC 11412 - Causing or attempting to cause other to refrain from exercising religion by threat.

CPC 11413 - Arson or destructive device at place of worship.

Misdemeanors

Hate Crimes

CPC 422.6 - Use of force, threats, or destruction of property to interfere with another's exercise of civil rights.

CPC 422.77 - Violation of civil order (Bane Act) protecting the exercise of civil rights

Related Crimes

CPC 302 - Disorderly conduct during an assemblage of people gathered for religious worship at a tax-exempt place of worship.

CPC 538(c) - Unauthorized insertion of advertisements in newspapers and redistribution to the public.

CPC 640.2 - Placing handbill, notice of advertisement on a consumer product or product packaged without authorization.

CPC 11411 - Terrorism of owner or occupant of real property. Placement or display of sign, symbol, or other physical impression without authorization, engagement in pattern of conduct, or burning or desecration of religious symbols.

Enhancements

CPC 190.2(a)(16) - Special circumstances imposing the Death Penalty or Life Without Possibility of Parole, if the victim was intentionally killed because of sexual orientation, gender, or disability.

CPC 190.3 - Special circumstances imposing LWOP if the victim was intentionally killed because of sexual orientation, gender, or disability.

CPC 422.75 - Penalty for felony committed because of victim's race, color, religion, nationality, country or origin, ancestry, disability, or sexual orientation shall be enhanced one, two, or three years in prison, if the person acts alone; and two, three, or four years if the person commits the act with another.

CPC 1170.8 - Enhancement for robbery or assault at a place of worship.

CPC 1170.85(b) - Felony assault or battery enhancement due to age or disability.

Reporting

CPC 13023- Requirement for law enforcement agencies to report hate crime data to DOJ.

WI 15630 – Elder and Dependent Adult Abuse Mandated Reporting (may apply in disability-related hate crimes).

Training and Policy Requirements

CPC 422.87 - Hate crimes policy adoption and update requirements (AB 1985, Effective January 1, 2019).

CPC 13519.6 - Defines hate crime training requirements for peace officers.

CPC 13519.41 - Training requirements on sexual orientation and gender identity-related hate crimes for peace officers and dispatchers (AB 2504, Effective January 1, 2019).

Miscellaneous Provisions

CPC 422.78 - Responsibility for prosecution of stay away order violations.

CPC 422.86 - Public policy regarding hate crimes.

CPC 422.89 - Legislative intent regarding violations of civil rights and hate crimes

CPC 422.92 - Hate crimes victims brochure requirement for law enforcement agencies.

CPC 422.93 - Protection of victims and witnesses from being reported to immigration authorities.

GC 6254 - Victim confidentiality.

**Resolution 2017-R025-Declaring-
Culver-City-a-sanctuary-city.pdf**

1 interrogate, detain, detect or arrest persons for immigration enforcement purposes,
2 including but not limited to inquiring into or collecting information about an individual's
3 immigration status, detaining an individual on the basis of a hold request, and responding
4 to requests for notification or transfer requests; and

5 **WHEREAS**, many cities and towns throughout the United States have
6 adopted resolutions, ordinances, policies and practices to demonstrate their commitment to
7 equal, respectful, dignified treatment of all people regardless of their immigration status,
8 and as a result may be referred to as "sanctuary cities;" and

9 **WHEREAS**, the City of Culver City desires to demonstrate its commitment to
10 fostering trust between City officials and the public, to protecting the safety, well-being and
11 constitutional rights of its residents and the people of the State of California, and to
12 directing the City's resources to matters of greatest concern to local government.

13 **NOW, THEREFORE**, the City Council of the City of Culver City, California, **DOES**
14 **HEREBY RESOLVE** as follows:

15 **SECTION 1.** The City of Culver City is a sanctuary city for all of its residents, and the
16 City stands in solidarity with other sanctuary jurisdictions. The City reaffirms its
17 commitment to welcome individuals with diverse backgrounds, and will uphold and protect
18 the human and civil rights of all individuals under the State and Federal Constitutions,
19 including the First Amendment rights of free speech and assembly, regardless of
20 immigration status.
21

22 **SECTION 2.** In furtherance of its policy agenda, the City of Culver City will act in a
23 manner consistent with the American Civil Liberties Union 9 Model State and Local Law
24 Enforcement Policies and Rules, as follows:
25

1 1. Judicial Warrant. City officials will require a judicial warrant before
2 detaining an individual or prolonging a detention in any manner at the request of federal
3 immigration authorities;

4 2. No Facilitation. City officials will require a judicial warrant before
5 arresting, detaining or transporting an individual solely on the basis of an immigration
6 detainer or other administrative document;

7 3. Defined Access. Unless pursuant to a court order or a legitimate law
8 enforcement purpose unrelated to civil immigration law, City officials will not permit federal
9 immigration authorities access to City facilities or to any person in City custody, subject to the
10 California Truth Act;

11 4. Clear Identification. Requiring federal immigration authorities to wear
12 jackets and badges when given access to City facilities, so that they are clearly identified as
13 federal agents;

14 5. Don't Ask. City officials will not inquire into the immigration status of any
15 individual, unless there is a legitimate law enforcement purpose unrelated to civil immigration
16 law, or where required by law to verify eligibility for a benefit or service;

17 6. Privacy Protection. City officials will not voluntarily release personally
18 identifiable information to federal immigration authorities, or information that may be used to
19 ascertain an individual's race, religion or ethnicity, unless for a law enforcement purpose
20 unrelated to the enforcement of civil immigration law;

21 7. Discriminatory Surveillance Prohibition. City officials will not engage in
22 surveillance of any person or group based solely on their actual or perceived religion,
23 ethnicity, race or immigration status;

1 8. Redress. Any person who alleges a violation of the above policies may
2 file a written complaint with the City.

3 9. Fair and Impartial Policing. City officials will not detain, interrogate, or
4 arrest an individual based on their perceived race, national origin, religion, language or
5 immigration status.

6 **SECTION 3:** The City also adopts the following in furtherance of its policy goals:

7 1. No City agency, department, officer, employee, or agent shall use City
8 funds, resources, facilities, property, equipment, or personnel to assist in the enforcement of
9 federal immigration law, unless such assistance is required by any valid and enforceable
10 federal or state law or is contractually obligated. This prohibition shall include, but not be
11 limited to, assisting with or participating in any immigration enforcement operation or joint
12 operation or patrol that involves, in whole or in part, the enforcement of federal immigration
13 law, except for purposes of protecting the public safety.

14 2. No City agency, department, officer, employee, or agent shall use City
15 funds, resources, facilities, property, equipment, or personnel to assist any federal program
16 requiring the registration of individuals on the basis of race, religion, or ethnicity, including
17 those persons of the Muslim faith or those perceived to be of the Muslim faith, and/or of
18 Middle Eastern descent.
19
20

21 ///

22 ///

23 ///

1
2 3. The City shall continue to follow its policies to prevent bias-based
3 policing and law enforcement personnel will continue to exercise discretion to favor citing
4 and releasing individuals in lieu of arrest or continued detention, where consistent with
5 protecting public safety.
6

7 APPROVED AND ADOPTED on the 27 day of March, 2017.
8

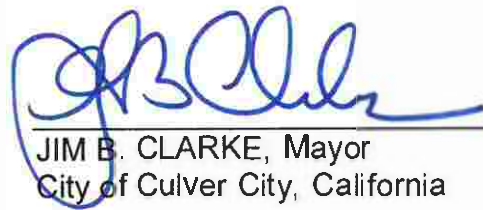
9 
10 _____
11 JIM B. CLARKE, Mayor
12 City of Culver City, California

13 ATTEST:

14 
15 _____
16 JEREMY GREEN, City Clerk

APPROVED AS TO FORM:

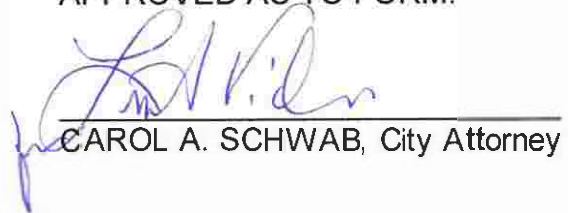
17 
18 _____
19 CAROL A. SCHWAB, City Attorney
20
21
22
23
24
25
26
27
28

A17-00169

Culver City PD Policy Manual

Culver City PD Policy Manual

INDEX / TOPICS

A

ABBREVIATIONS.	14
ACCOUNTABILITY TO SUPERVISOR.	21
ACKNOWLEDGEMENTS	
Policy manual.	15
ADMINISTRATIVE INVESTIGATION.	84
ADMINISTRATIVE INVESTIGATIONS	
OIS.	84, 84, 84
OIS.	84, 84
Vehicle damage.	554
AIRCRAFT	
Accidents.	447
Ambulance.	433
ALCOHOL.	637
ALCOHOL	
Vehicle use.	551
ALCOHOL, INTOXICANTS.	208
ALCOHOL USE.	637
AMMUNITION.	90
Gun violence restraining order surrenders.	286
ANIMALS.	598
Line-of-duty deaths.	750
APPOINTMENTS	
Community relations coordinator.	289
Forfeiture reviewer.	515
Reserve coordinator.	225
ARRESTS	
First amendment assemblies.	422, 424
ASSET FORFEITURE.	512
AUDIO/VIDEO RECORDING	
Body-worn cameras.	390
Custodial interrogation.	499
AUTHORITY	
Canine handler.	115
Policy manual.	14
AUTHORITY, ETHICS.	204

B

BADGE	
Mourning Badge.	698
BIOLOGICAL SAMPLES.	263
BIOLOGICAL SAMPLES	
Hazards.	448

BODY ARMOR.	662
BODY-WORN CAMERAS.	390
BOMBS.	344
Aircraft accidents.	448
MDT/MDC.	389
BRADY MATERIAL.	530
BREATH TEST.	485
BUCCAL SWABS.	264

C

CANINES	
Pursuits.	399
CASH	
Custodial searches.	606
CHANGE OF ASSIGNMENT.	673
CHIEF EXECUTIVE.	11
CHILD ABUSE.	166
CHILDREN	
Transporting.	661
CITATIONS.	472
CIVIL	
Subpoenas.	221
CIVIL DISPUTES.	428
CIVILIAN/NONSWORN	
Crisis intervention incidents.	418
CIVIL RESPONSE TEAM.	86
CODE-3.	111
COMMAND PROTOCOL.	21
COMMENDATIONS AND AWARDS.	674
COMMUNICABLE DISEASE	
Health orders.	328
COMMUNICATIONS CENTER	
Crisis intervention incidents.	417
COMMUNICATIONS CENTER	
Foot pursuits.	402
COMMUNICATIONS WITH HEARING	
IMPAIRED OR DISABLED.	254
COMMUNITY RELATIONS.	289
COMPUTERS	
Digital evidence.	501
CONDUCT	
Meritorious.	675
OIS.	77
Standards of conduct.	204
CONFIDENTIALITY	
Radio broadcasts.	388
CONTROL DEVICES.	66
CONTROL DEVICES	
Training.	365
CORRESPONDENCE.	26
COURT APPEARANCES.	220

Culver City Police Department

Culver City PD Policy Manual

Culver City PD Policy Manual

COURT ORDERS

Gun violence restraining order surrenders.	286
Subpoenas.	220
COURT ORDERS, CIVIL DISPUTES.	428
CRIME ANALYSIS.	565
CRIME SCENE AND DISASTER INTEGRITY.	327
CRISIS INTERVENTION INCIDENTS.	415
CRISIS NEGOTIATION TEAM.	457
CRISIS RESPONSE UNIT.	457
CUSTODIAL INTERROGATIONS.	499
CUSTODIAN OF RECORDS.	596

D

DAMAGE BY CITY PERSONNEL.	214
DEADLY FORCE REVIEW.	56
DEATH NOTIFICATION.	241
DEBRIEFING	
Tactical.	86
DEFECTIVE VEHICLES.	547
DEFINITIONS.	14
DEPARTMENT OWNED PROPERTY.	543
DEPARTMENT PROPERTY	
Loss Or Damage.	544
DISABLED	
Motorist.	495
DISASTER PLAN.	23
DISCIPLINE.	203
DISTRIBUTION.	15
DRIVING	
MDT/MDC.	387
DRIVING, SAFETY SAFETY, CONDUCT	
FIREARMS, CONDUCT.	208
DRUG USE.	637
DUI ENFORCEMENT.	484

E

ELECTRICAL LINES.	366
ELECTRONIC CIGARETTES.	647
ELECTRONIC MAIL.	24
EMERGENCY MANAGEMENT PLAN.	23
EMERGENCY UTILITY.	366
EQUIPMENT.	319
EVALUATION.	629
EVIDENCE	
Digital.	501
Seizing recordings.	413
EVIDENCE, BOMBS.	348
EXPLOSIONS.	347

F

FIELD SOBRIETY TESTS.	484
FINGERPRINTING.	325
FIREARMS	
Destruction of animals.	601
Removal for vehicle maintenance.	547
Retiree.	35
FIRING RANGE.	97
FITNESS FOR DUTY.	676
FLYING FLAG AT HALF-STAFF.	276
FORCE.	56
FOREIGN DIPLOMATIC AND CONSULAR REPRESENTIVES.	359

G

GENERAL ORDER.	22
GRIEVANCE PROCEDURE.	633
GROOMING STANDARDS.	732

H

HAZARDOUS MATERIAL (HAZMAT) RESPONSE	
Aircraft accidents.	448
HEARING IMPAIRED.	254
HELICOPTER ASSISTANCE.	376
HIGH-VISIBILITY VESTS.	472
HOMELESS.	409

I

IDENTITY THEFT.	245
INFORMATION TECHNOLOGY USE	
TECHNOLOGY USE.	209
INVESTIGATION AND PROSECUTION.	497

J

JURISDICTION	
Aircraft accidents.	448
OIS.	77

K

KEYS	
------	--

Culver City Police Department

Culver City PD Policy Manual

Culver City PD Policy Manual

Vehicle.	550	LEOSA.	35
		Seat belts.	660
		Warrant service.	532
L		ORGANIZATIONAL STRUCTURE.	19
LEAVE OF ABSENCE.	684	OUTSIDE AGENCY ASSISTANCE.	232
LIMITED ENGLISH PROFICIENCY.	248	OUTSIDE EMPLOYMENT.	687
LIMITED ENGLISH PROFICIENCY		Change in Status.	690
Eyewitness identification.	526	Obtaining Approval.	687
LIVE SCAN.	325	Prohibited Outside Employment.	688
		Security Employment.	689
M		OVERTIME	
MANUALS.	23	Court.	222
MEAL PERIODS AND BREAKS.	679	OVERTIME PAYMENT.	683
MEDIA			
Aircraft accidents.	449	P	
OIS.	86	PARKING.	551
MEDICAL		PERFORMANCE EVALUATIONS	
Aircraft accidents.	447	Sick leave.	641
For canines.	119	PERSONAL APPEARANCE.	732
Releases.	433	PERSONAL PROPERTY.	543
MENTAL ILLNESS		Loss Or Damage.	544
Restraints.	349	PHOTOGRAPHS	
MINIMUM STAFFING.	27	Aircraft accidents.	449
MOBILE DIGITAL TERMINAL USE.	387	POLICE FACILITY VISITORS.	325
MODIFIED-DUTY ASSIGNMENTS.	722	POLICY MANUAL.	13
MUTUAL AID		POLITICAL ACTIVITY.	730
Tactical Mobilization.	329	POLITICAL ENDORSEMENTS.	730
MUTUAL AID		PRIVACY EXPECTATIONS	
First amendment assemblies.	423	Audio/video recordings.	390
Warrant service.	534	MDT/MDC.	387
		PRIVATE PERSONS ARRESTS.	246
N		PROPERTY PROCEDURES	
NONSWORN		Narcotics And Dangerous Drugs.	569
Vehicles.	551	Packaging Of Property.	570
NOTIFICATION.	79	PUBLIC RECORDING OF LAW	
NOTIFICATIONS		ENFORCEMENT ACTIVITY.	412
Aircraft accidents.	448	PURSUITS	
Impaired driving.	486	Foot.	399
Sick leave.	640		
O		R	
OATH OF OFFICE.	12	RAPID RESPONSE AND DEPLOYMENT.	363
OFFICER SAFETY		RECORDS BUREAU	
Crime scene and disaster integrity.	327	Administrative hearings.	488
Foot pursuits.	399	Suspicious activity reports.	431
		RECORDS RELEASE	
		Audio/video recordings.	391
		Child deaths.	173
		Subpoenas and discovery requests.	586
		RECORDS RETENTION	

Culver City Police Department

Culver City PD Policy Manual

Culver City PD Policy Manual

Oath of office.	12
REFLECTORIZED VESTS.	472
REPORT CORRECTIONS.	215
REPORT PREPARATION.	212
REQUIRED EQUIPMENT.	319
RESERVE	
Duties.	225
RESERVE OFFICERS	
Firearms Requirements.	228
Training.	226
RESERVE OFFICERS/DEPUTIES.	223
RESPONSE TO CALLS.	111
RESTRAINTS.	349
REVIEWS	
Crisis intervention incidents.	419
Policy manual.	16
Public records on social media.	282
RIDE-ALONG.	334
Eligibility.	334
ROLL CALL TRAINING.	324

S

SAFETY	
Canine.	550
First responder.	327
SAFETY EQUIPMENT	
First amendment assemblies.	422
Seat belts.	660
SCHOOL EMPLOYEE REPORTING.	261
SEARCH & SEIZURE.	131
SEARCHES	
Crime scene.	327
Gun violence restraining orders.	285
SECURITY.	326
SECURITY EMPLOYMENT.	689
SHOTGUN.	371
SMOKING AND TOBACCO USE.	647
SOCIAL MEDIA.	280
SOCIAL NETWORKING.	728
STAFFING LEVELS.	27
STANDARDS OF CONDUCT.	202
SUBPOENAS	
Records release and discovery requests.	586
SUBPOENAS AND COURT APPEARANCES	220
SUCCESSION OF COMMAND.	21
SUSPICIOUS ACTIVITY REPORTING.	430

T

TACTICAL MOBILIZATION	
-----------------------	--

Mutual Aid.	329
TAKE HOME VEHICLE.	552
TERRORIST ACTIVITY.	525
TERRORIST LIAISON OFFICERS	
TLO.	525
TOLL ROADS.	554
TRAFFIC FUNCTION AND	
RESPONSIBILITY.	471
TRAFFIC OFFICER/DEPUTY.	471
TRAFFIC SIGNAL.	366
TRAINING	
SWAT.	462
TRAINING	
Canine.	119
Firearms.	93
Impaired driving.	488
Rapid response and deployment.	365
Social media.	282
TRAINING PLAN.	40
TRAINING POLICY.	40

U

UNIFORMS	
Courtroom attire.	222
UNITY OF COMMAND.	21
USE OF SOCIAL MEDIA.	280
UTILITY SERVICE.	366

V

VEHICLE MAINTENANCE.	547
VEHICLES	
Impound hearings.	482

W

WARNINGS	
Canine.	116
WARRANT SERVICE.	532
WASHING OF VEHICLES.	548
WATCH COMMANDERS.	386
WATCH ROTATION.	58
WATER LINES.	366